



TL- 2810R

六類遮罩三件套水晶頭 壓線鉗

專業壓六類遮罩三件套水晶頭，8P8C/6P6C/6P4C/6P2C

【特性】

專業壓制最為高端的原裝六類三件套遮罩水晶頭；金屬疊片座頭，超長使用壽命；棘齒省力結構，自動到位，輕鬆回彈；特種軟膠手柄，給您舒適感覺。

勝特力材料 886-3-5753170
勝特力电子(上海) 86-21-34970699
勝特力电子(深圳) 86-755-83298787
[Http://www.100y.com.tw](http://www.100y.com.tw)



勝特力材料 886-3-5753170
 勝特力电子(上海) 86-21-34970699
 勝特力电子(深圳) 86-755-83298787
[Http://www.100y.com.tw](http://www.100y.com.tw)

TELECOMMUNICATION & NETWORKING TOOLS
 CATV INSTALLATION TOOLS
 FIBER OPTIC CONNECTOR CRIMPING TOOLS
 PUNCH DOWN TOOLS
 ALL KINDS OF TOOL KITS WITH DIFFERENT COMBINATION
 OEM,ODM WORKS



TALON TOOLS

TALON TOOLS

TALON PROFESSIONAL TOOLS

Add:No.6,west section West Street,West Development
 Zone,Guanhaiwei Town,Cixi City,Ningbo,China
 Tel:+86-574-63625585 13777040862
 Direct:+86-574-63625587
 Fax:+86-574-63625586
 E-mail:talon@talontool.com,sales@talontool.com
[Http://www.talontool.com](http://www.talontool.com)





TALON TOOLS FACTORY PROFILE

TALON tools co.,ltd is a professional manufacturer of network tools many kinds of telecommunication network,Fiber Optic,Telephone and other electronic products.It is located in Cixi Ningbo,the most industrialized city in China and has been devoting itself to design.development and production.We always uphold the management principle of living advanced technology and provide most advanced and satisfactory network tools to our customers.

Meanwhile,our experienced technicians,skilled workers and modern management system ensure full capability to develop customized' OEM products.And we have passed ISO9001-2000 system.

Our main objective is to fulfill customers'needs and to satisfy customers.Our quality products and perfect service win us high reputation in the worldwide market.Our telecommunication network products feature high performance and reasonable price.We have been exported to Europe,Middle East,South-east Asia etc and gained a high reputation.We are looking forward to cooperating with customers all over the world and creating mutual prosperity!



Professional Modular Crimps Strips & Cuts Tool

Professional Modular Crimps, Strips & Cuts Tool

- Tool 200A/200AR/200/200R design with 10 position punches.
For crimping 8P8C plug, please use AMP 8P8C plug with 2 extra cavities on each side as Fig 1.
- Tool 2008A/2008AR/2008/2008R design with 8 position punches.
For crimping the ordinary 8P8C plug, this kind of 8P plug without additional cavity on each side as Fig. 2.
- Adjusting the 6P guide: use a flat (slot) screw driver to set the guide to right side for crimping normal 6P plug and set the guide to left side for crimping DEC plug.
- Built-in round cable stripper.

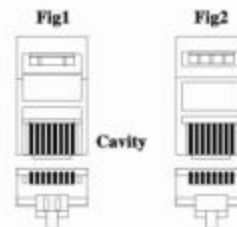

TL-2810R
8.5"(215mm)



TL-200AR/2008AR
8.3"(210mm)



TL-200A/2008A
8.3"(210mm)



TL-	For crimping modular plug	Ratchet
2810	8P8C/RJ-45, 6P6C/RJ-12, 6P4C/RJ-11	No
2810R	RJ45(CAT-6 8P8C)-AMP	Yes

TL-	For crimping modular plug	Ratchet
200/200A	10P10C, AMP 8P8C/RJ-45, 6P6C/RJ-12, 6P4C/RJ-11, 4P4C & 4P2C PLUGS & DEC/OFF SET PLUG-6P6C	No
200R/200AR	4P4C & 4P2C PLUGS & DEC/OFF SET PLUG-6P6C	Yes
2008/2008A	8P8C/RJ-45, 6P6C/RJ-12, 6P4C/RJ-11, 4P4C & 4P2C PLUGS & DEC/OFF SET PLUG-6P6C	No
2008R/2008AR	4P2C PLUGS & DEC/OFF SET PLUG-6P6C	Yes

Replacement blade: TL-RB0809C
Use with TL-S501A/TL-S501B for stripping UTP/STP round wire.(Page 8)

TL-200/200R/2008/2008R
8"(203mm)

Multi-Modular Plug Crimps, Strips & Cuts Tools

- Deluxe type, frame is made of steel, light weight, compact & durable w/key way in 8P modular holder.
- Cut and strip wire by one operation, easy and efficient.
- With round cable stripper.
- 4P crimper on the back side of the tool.

TL-	For crimping modular plug	Ratchet
N5684	8P8C/RJ-45, 6P6C/RJ-12, 6P4C/RJ11, 4P4C & 4P2C PLUGS	No
N5684R		Yes

Replacement blade: TL-RB08S



TL-N5684
7.3"(185mm)

TL-	For crimping modular plug
468S	8P8C/RJ-45, 6P6C/RJ-12, 6P4C/RJ-11 & 6P2C 4P4C & 4P2C

TL-	For Crimping Modular Plug
315	8P8C/RJ-45, 6P6C/RJ-12, 6P4C/RJ-11 & 6P2C, 4P4C & 4P2C



TL-315
7.7"(195mm)



TL-468S
8"(203mm)

TL-N5684R
7.3"(185mm)

Dual-Modular Plug Crimps, Strips & Cuts Tools

- Straight motion & professional type, provide precise operation with key way in 8P modular holder.
- Modular holders are made of AL-ZN. Alloy light weight & durable.
- Suitable for both stranded & solid wire.(UTP/STP)

TL-	For crimping modular plug	Ratchet
500	8P8C/RJ-45, 6P6C/RJ-12, 6P4C/RJ-11 PLUGS	No
500R	Same as TL-500, but w/ratchet	Yes

Replacement blade: TL-200SC



TL-500R
7.6"(192mm)



TL-N568R
7.3"(185mm)

- Deluxe type, frame is made of steel, light weight, compact & durable w/key way in 8P modular holder.
- TL-546R/568R/N568R are with ratchet mechanism.

TL-	For crimping modular plug	Ratchet
546		No
546R	6P6C/RJ-12, 6P4C/RJ-11, 4P4C & 4P2C	Yes
568/N568	8P8C/RJ-45, 6P6C/RJ-12, 6P4C/RJ-11	No
568R/N568R	with round cable stripper	Yes

Replacement blade: TL-546/546R/568/568R... TL-200S
TL-N568/N546R... TL-RB08S



TL-N568
7.3"(185mm)

- For cutting/Stripping /Crimping 2 types.of plugs in 1 tool

TL-	For crimping modular plug
8086R	8P8C/RJ-45, 6P6C/RJ-12, 6P4C/RJ-11 & 6P2C



TL-8086R
8"(203mm)

Dual-Modular Plug Crimps, Strips & Cuts Tools

◎All metal constructions, rigid type.
For crimping stranded wire only.

TL~	For crimping modular plug
26B	Normal 6P6C/RJ-12, 6P4C/RJ-11 & 6P British Plug

◎Replacement blade: TL-200SC

◎Use with TL-S501A/TL-S501B for stripping UTP/STP round wire.(page 8)



TL-26B
8"(203mm)



TL-268
8"(203mm)



TL-246
8"(203mm)

TL~	For Crimping Modular Plug
318	8P8C/RJ-45, 6P6C/RJ-12, 6P4C/RJ-11 & 6P2C



TL-318
7.5"(190mm)

Dual-Modular Plug Crimps, Strips & Cuts Tools

TL~	For crimping modular plug
46	6P6C/RJ-12 & 6P4C/RJ-11 & 6P2C, 4P4C & 4P2C
86	8P8C/RJ-45, 6P6C/RJ12, 6P4C/RJ-11 & 6P2C



TL-86
7.9"(200mm)



TL-46
7.9"(200mm)

3 Ways Modular Tool: Crimps, Strips & Cuts

TL~	For crimping modular plug	Repl.Blade
3684	4P4C&4P2C	TL-RB06S
3686	6P6C/RJ12, 6P4C/RJ11 & 6P2C	TL-RB06S
3688	8P8C/RJ-45(Available for stripping round cable.)	TL-RB0609



4P4C & 4P2C

6P6C/RJ12

8P8C/RJ45



TL-3686
7.9"(200mm)

3 Ways Modular Tool: Crimps, Strips & Cuts

TL-	For crimping modular plug	Repl. Blade
2094C	4P4C & 4P2C	TL-200S
2096C	6P6C/RJ-12, 6P4C/RJ-11 & 6P2C	TL-200S
210N/210C	8P8C/RJ-45 (Available for stripping round cable.)	TL-RB08S
2092C	DEC/OFF SET PLUG 6P6C MMJ	TL-RB08S
209C	10P10C	TL-200S



TL-210N
7.9"(200mm)



TL-210C
7.9"(200mm)

- Steel frame, harden & black oxide finished, light weight & durable.
- Deluxe type, w/guide for operation.
- An additional locker for storage after work.

TL-	For crimping modular plug	Repl. Blade
206M	6P6C/RJ12, 6P4C/RJ11 & 6P2C	TL-RB06S
208M	8P8C/RJ-45 (Available for stripping round cable.)	TL-RB0609



TL-208M
7.9"(200mm)



TL-218M
7.1"(180mm)

TL-	For Crimping modular plug
218M	8P8C/RJ-45

Ratchet Type – Modular Plug Crimping Tool

TL-	For crimping modular plug
236-4P	FOR 4P4C/RJ22
236-6P	FOR 6P2C, 6P4C/RJ11, 6P6C/RJ12
236-8P	FOR 8P8C/RJ45
236-68P	FOR 6P2C, 6P4C/RJ11, 6P6C/RJ12, 8P8C/RJ45
236-8PAMP	FOR AMP 8P8C/RJ45 (Secondary strain relief)
236-10P	FOR 10P 10C
236BT	FOR 6P BRITISH PLUGS
236DEC	FOR 6P6C DEC/OFF SET
236M5	MOLEX 8P8C/RJ45 PLUG & CABLE O/D AROUND 5.2φ
236M6	MOLEX 8P8C/RJ45 PLUG & CABLE O/D AROUND 5.8φ
236Q	HC-002-8S 8P8C/RJ45 SHIELDED PLUGS (Hirose type short body)
236Q1	HIROSE 8P8C/RJ45 SHIELDED PLUGS(Old item no TL336Q)
236Q3	ADSL 6P4C/RJ11 SHIELDED PLUGS(Old item no TL-336Q3)
236S	STEWART 8P8C/RJ45 SHIELDED PLUGS



TL-236Q1
8.7"(220mm)

236M5		Molex type
236M6		Molex type
236Q		Hirose type Short body
236Q1		Hirose type
236Q3		ADSL type
236S		Stewart type



TL-236-8P
8.7"(220mm)

3 Ways Modular Tool: Crimps, Strips & Cuts

TL-	For crimping modular plug
808	8P8C/RJ-45



TL-808
7.9"(200mm)

Professional Compression Crimping Tools



TL-H510B
7.7"(195mm)

TL-	Description
H510B	For F, BNC, RCA, right angled and keystone module compression connectors, Available for RG59 and RG6 cables. With adjustment for crimping different length of connectors.

Professional Compression Crimping Tools

For crimping RG59, RG6 and RG11 F type compression connectors

TL-	For crimping F connector	Compressed distance
H548A	RG-59/6	15.5-21.3mm
	RG 11	30.5-36.0mm
H548B	RG-59/6	19.7-20.3mm
	RG 11	34.8-35.4mm



TL-H548A
6.8"(174mm)

Rotatable

Works on F type RG-59(4C) & RG-6(5C) compression connectors

TL-	For crimping F connector	
507	RG-59(4C),RG-6(5C)	 Before Crimp
		 After Crimp



TL-507
9.3"(266mm)

Works on F type RG-59(4C) & RG-6(5C) compression connectors

TL-	For crimping F connector	Compressed distance
508		20.30±0.15mm
508A		19.30±0.15mm
508B	RG-59(4C), RG-6(5C)	19.70±0.15mm
508C		20.70±0.15mm
508D		21.30±0.15mm
508N	RG-59(4C), RG-6(5C) Non-Ratchet Type	20.30±0.15mm
508BNC	RG-59/6 BNC connector	31.50±0.15mm (Max.open 41mm)



Before Crimp



After Crimp

Use TL-332(2-Blades) or TL-322(3-Blades) for stripping cable.(Page 25, 26)

Use TL-206 & TL-C206A for cutting cables.(Page 37, 38)



TL-508
8.5"(216mm)

Professional Compression Crimping Tools

○With a handle lock

TL-	For crimping F connector	Compressed distance
H518A	RG-59(4C),RG-6(5C)	20.30±0.15mm
H518A1		19.30±0.15mm
H518A2		19.70±0.15mm
H518A3		20.70±0.15mm
H518A4		21.00±0.15mm



TL-518A
5.6"(143mm)

TL-	For crimping F connector	Compressed distance
H518B	RG-59(4C),RG-6(5C)	20.30±0.15mm
H518B1		19.30±0.15mm
H518B2		19.70±0.15mm
H518B3		20.70±0.15mm
H518B4		21.00±0.15mm



TL-518B
5.6"(143mm)

TL-	Compressed Distance For F connector	Compressed Distance For BNC connector	Compressed Distance For RCA connector
H518E1	20.30±0.20mm	32.8±0.20mm	33.1±0.20mm
H518E2	20.30±0.20mm	33.9±0.20mm	31.6±0.20mm
H518F1	20.30±0.20mm	32.8±0.20mm	33.1±0.20mm
H518F2	20.30±0.20mm	33.9±0.20mm	31.6±0.20mm



TL-518F1
5.9"(150mm)



TL-518E1
5.9"(150mm)

Professional Compression Crimping Tools

○For crimping RG-58/59/62/6(3C/4C/5C) F type compression

TL-	For crimping F connector	Compressed distance
5080R	RG-58/59/62/6(3C/4C/5C)	18.0-22.0

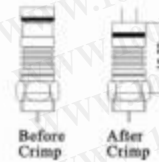

TL-5080R
8.1"(206mm)

Adjustable(17.5~21.5)

○For crimping F/BNC/RCA RG-58/59/62/6(3C/4C/5C) type compression

TL-	Compressed Distance for F connector	Compressed Distance for BNC connector	Compressed Distance for RCA connector
5081R	20.8±0.2mm	33.2±0.20mm	33.2±0.20mm

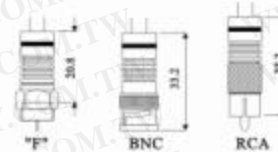

TL-5081R
8.1"(206mm)

Interchangeable "F" (BNC,RCA)

○For crimping F/BNC/RCA RG-58/59/62/6(3C/4C/5C) type compression

TL-	Compressed Distance for F connector	Compressed Distance for BNC connector	Compressed Distance for RCA connector
5082R	15.8-25.8mm	28.2-38.2mm	28.2-38.2mm

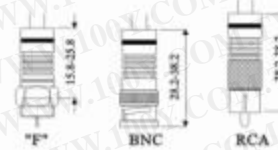

TL-5082R
9.1"(231mm)

Interchangeable "F" (BNC,RCA)

Professional Compression Crimping Tools

For Waterproof Connectors Crimping Tool
"F" Connectors RG-11(7C)

TL-	For crimping F connector	Compressed distance
5083R	RG-11(7C)	25.5-35.5mm

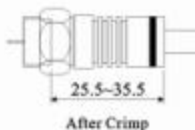

TL-5083R
9.1"(231mm)

Adjustable(25-35)

For Waterproof Connectors Crimping Tool
"F" Connectors RG-11(7C)

TL-	For crimping F connector	Compressed distance
5084R	RG-11(7C)	41-44mm

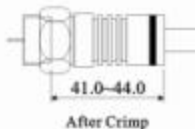

TL-5084R
9.1"(231mm)

Adjustable(40.5-43.5)

For crimping RG59, RG6, and RG11 F type Compression

TL-	For crimping F connector	Compressed distance
5087	RG-59/6	19.3-21.0mm
	RG-11	25.5-35.5mm



TL-5087
7.3"(185mm)

Professional Compression Crimping Tools

For Waterproof Connectors Crimping Tool
"F" Connectors

TL-	For crimping F connector	Compressed distance
5085	RG-58/59/62/6(3C/4C/5C)	18.0-22.0

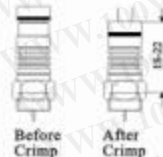

TL-5085
5"(127mm)

For Waterproof Connectors Crimping Tool
F/BNC/RCA RG-58/59/62/6(3C/4C/5C)

TL-	Compressed Distance for F connector	Compressed Distance for BNC connector	Compressed Distance for RCA connector
5086	15.8-25.8mm	28.2-38.2mm	28.2-35.2mm

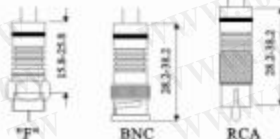

TL-5086
5.6"(142mm)

Interchangeable "F" (BNC, RCA)

IDC Crimping Fixture & Attachment

TL-214	For crimping IDC-type of connectors on to ribbon cable. Crimping from height 6mm distance to 27.5mm (max. 55mm width)
TL-214D	For crimping DIP plug, special attachment with dual slot for the plug distance "D" in 0.1", 0.3" & 0.6". (max. 58mm width)

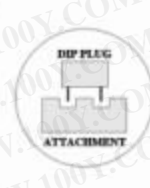
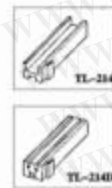

TL-214
9.5"(241mm)

Ratchet Crimping Tools

Professional Crimping Tools Ratchet Type



TL-225FM
(Frame only)
7.8"(200mm)



TL-436FM
(Frame only)
8.9"(226mm)

Item No	2250	2251	2252
			
Die P/N	2250 Die	2251 Die	2252 Die
Specifications	.255"/.210"/.067"/.060" 6.48/5.33/1.70/1.52mm	.320"/.210"/.060" 8.13/5.33/1.52mm	.320"/.250"/.210" 8.13/6.35/5.33mm
Crimping cable size	RG58,59,6	RG58,6	RG58,59,62,6

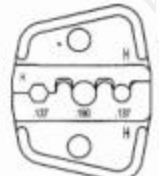
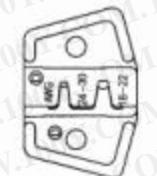
Item No	2253	225H	225D
			
Die P/N	2253 Die	225H Die	225D Die
Specifications	.320"/.275"/.065" 8.13/7.00/1.65mm	.137"/.190"/.137" 3.48/4.83/3.48mm	AWG 18-22/24-30
Crimping cable size	RG6,Belden 8281	ST,SC Fiber Optic Connector(Oval size)	D-Sub Terminal



Professional Crimping Tools Ratchet Type

○Die sets are interchangeable,except TL-301
○OEM/Custom designs are welcome



TL-536FM
(Frame only)
8.7"(220mm)

TL-336FM
(Frame only)
8.7"(220mm)

Item No	TL-536A/TL-436A/TL-336A	TL-532A/TL-432A/TL-236A	TL-536C/TL-436C/TL-336C
Die P/N	3A	2A	3C
Specifications	.256"/.068"/.213" 6.50/1.73/5.41mm	.255"/.187"/.068"/.213" 6.48/4.75/1.73/5.41mm	.256"/.319"/.068"/.213" 6.50/8.10/1.73/5.41mm
Crimping cable size	RG58,59,62	RG58,59,62,174	RG58,59,62,6

Item No	TL-536C1/TL-436C1/TL-336C1	TL-536C2/TL-436C2/TL-336C2	TL-536D/TL-436D/TL-336D
Die P/N	3C1	3C2	3D
Specifications	.068"/.216"/.324"/.360" 1.73/5.49/8.23/9.14mm	.068"/.262"/.324"/.360" 1.73/6.65/8.23/9.14mm	.213"/.256"/.068"/.324" 5.41/6.50/1.73/8.23mm
Crimping cable size	RG58,59,62,6	CATV "F" Connectors RG59,6	RG58,59,62,6

Professional Crimping Tools Ratchet Type

Item No	TL-536D1/TL-436D1/TL-336D1	TL-536D2/TL-436D2/TL-336D2	TL-536D3/TL-436D3/TL-336D3
Die P/N	3D1	3D2	3D3
Specifications	.068"/.178"/.324" 1.73/4.52/8.23mm	.256"/.429"/.068"/.213" 6.50/10.90/1.73/5.41mm	.390"/.275"/.065" 9.90/6.98/1.65mm
Crimping cable size	RG58,6,174	RG58,59,62,11,8,213	RG213,6,8,59

Item No	TL-536F1/TL-436F1/TL-336F1	TL-536F2/TL-436F2/TL-336F2	TL-536F3/TL-436F3/TL-336F3
Die P/N	3F1	3F2	3F3
Specifications	.042"/.068"/.133"/.162"/.195" 1.07/1.73/3.38/4.11/4.95mm	.042"/.068"/.151"/.178"/.213" 1.07/1.73/3.84/4.52/5.41mm	.151"/.178"/.213" 3.84/4.52/5.41mm
Crimping cable size	Fiber Optic SMA (Oval Type)	Fiber Optic SMA, SMB Conn. RG58,174,Belden 8281	RG58,174,179

Item No	TL-536F4/TL-436F4/TL-336F4	TL-536G/TL-436G/TL-336G	TL-536G1/TL-436G1/TL-336G1
Die P/N	3F4	3G	3G1
Specifications	.151"/.178"/.134"/.139"/.190" 3.84/4.52/3.40/3.53/4.83mm	.043"/.068"/.100"/.137"/.213"/.255" 1.09/1.73/2.54/3.48/5.41/6.48mm	.042"/.068"/.190"/.213" 1.07/1.73/4.83/5.41mm
Crimping cable size	Fiber Optic ST,SC,LC connectors	RG58,59,62,174 Fiber Optic	RG58, Fiber Optic

Professional Crimping Tools Ratchet Type

Item No	TL-536G2/TL-436G2/TL-336G2	TL-536G3/TL-436G3/TL-336G3	TL-536G4/TL-436G4/TL-336G4
Die P/N	3G2	3G3	3G4
Specifications	.235"/.128"/.065"/.042" 5.97/3.25/1.65/1.07mm	.042"/.068"/.255"/.324" 1.07/1.73/6.48/8.23mm	.042"/.068"/.178"/.278"/.255" 1.07/1.73/4.52/7.06/6.48mm
Crimping cable size	RG58,174,139,185	RG174,58,59,6	RG59,62,174

Item No	TL-536H1/TL-436H1/TL-336H1	TL-536H2/TL-436H2/TL-336H2	TL-532I/TL-432I/TL-236I
Die P/N	3H1	3H2	2I
Specifications	.255"/.320"/.350" 6.48/8.13/8.89mm	.320"/.210"/.185" 8.13/5.33/4.70mm	.248"/.204"/.090"/.068"/.311" 6.30/5.18/2.29/1.72/7.90mm
Crimping cable size	CATV F Connectors RG59,6	RG58,6	RG58,59,6,174

Item No	TL-536J/TL-436J/TL-336J	TL-536K/TL-436K/TL-336K	TL-536K2/TL-436K2/TL-336K2
Die P/N	3J	3K	3K2
Specifications	.042"/.068"/.078"/.128"/.151"/.178" 1.07/1.73/1.98/3.25/3.84/4.52mm	.100"/.128"/.429" 2.54/3.25/10.90mm	.068"/.256"/.429" 1.73/6.50/10.90mm
Crimping cable size	RG174,179,Belden 8218 Fiber Optic	RG8,11,174,179,213	RG8,11,59,62

Professional Crimping Tools Ratchet Type

Item No	TL-536K3/TL-436K3/TL-336K3	TL-536K4/TL-436K4/TL-336K4	TL-536K5/TL-436K5/TL-336K5
Die P/N	3K3	3K4	3K5
Specifications	.256"/.068"/.295" 6.50/1.73/7.49mm	.100"/.128"/.190"/.213" 2.54/3.25/4.83/5.41mm	.080"/.100"/.429" 2.03/2.54/10.90mm
Crimping cable size	RG59,6	RG58,174,Fiber Optic	RG11,174,213

Item No	TL-536K6/TL-436K6/TL-336K6	TL-536M/TL-436M/TL-336M	TL-532PA/TL-432PA/TL-236PA
Die P/N	3K6	3M	2PA
Specifications	.429"/.075"/.075" 10.90/1.91/1.91mm	.228"/.068"/.305" 5.79/1.73/7.75mm	.255"/.213"/.100"/.068"/.324" 6.48/5.41/2.50/1.72/8.23mm
Crimping cable size	RG11,213	RG58,59,6,62,142	RG58,59,62,6

Item No	TL-536T1/TL-436T1/TL-336T1	TL-536V/TL-436V/TL-336V	TL-536V1/TL-436V1/TL-336V1
Die P/N	3T1	3V	3V1
Specifications	.028"/.039"/.047"/.100"/.128"/.151" 0.71/0.99/1.19/2.54/3.25/3.84mm	.043"/.069"/.100"/.128"/.151"/.213" 1.09/1.75/2.54/3.25/3.84/5.41mm	.047"/.068"/.178"/.217"/.256"/.330" 1.19/1.73/4.52/5.51/6.50/8.38mm
Crimping cable size	RG174,178,179,180,187	SMA,SMB,SMC,MCX	RG59,62,6,174, Fiber Optic

Professional Crimping Tools Ratchet Type

Item No	TL-536Y/TL-436Y/TL-336Y	TL-536Y1/TL-436Y1/TL-336Y1	TL-536Y2/TL-436Y2/TL-336Y2
Die P/N	3Y	3Y1	3Y2
Specifications	.044"/.057"/.068"/.220"/.213" 1.12/1.45/1.73/5.59/5.41mm	.218"/.069" 5.54/1.75mm	.042"/.240" 1.07/6.10mm
Crimping cable size	RG58	RG58(Oval Type)	Pin Terminal, Insulated or non-insulated ferrules(Oval Type)

Item No	TL-532C/TL-432C/TL-236C	TL-532CL/TL-432CL/TL-236CL	TL-532C2/TL-432C2/TL-236C2
Die P/N	2C	2CL (W / LOCATOR)	2C2
Specifications	AWG 20-18/16-14/12-10 DIN 0.5-1.0/1.5-2.5/4-6mm ²	AWG 20-18/16-14/12-10 DIN 0.5-1.0/1.5-2.5/4-6mm ²	AWG 20-18/16-14 DIN 0.5-1.0/1.5-2.5mm ²
Crimping cable size	Non-Insulated Terminal or Open Barrel Terminal	Non-Insulated Terminal or Open Barrel Terminal	Non-Insulated Terminal or Open Barrel Terminal

Item No	TL-532C3/TL-432C3/TL-236C3	TL-532C4/TL-432C4/TL-236C4	TL-536E/TL-436E/TL-336E
Die P/N	2C3	2C4	3E
Specifications	AWG 24-30/18-22 DIN 0.25-0.05/1.0-0.5mm ²	AWG 24-28/20-22 DIN 0.25-0.08/0.75-0.5mm ²	AWG 22/20/18/16/14/12 DIN 0.50/0.75/1.0/1.5/2.5/4mm ²
Crimping cable size	D-Sub Terminal	D-Sub Terminal	Pin Terminal Insulated or Non-Insulated Ferrules

Professional Crimping Tools Ratchet Type

Item No	TL-536S/TL-436S/TL-336S	TL-536E2/TL-436E2/TL-336E2	TL-536E3/TL-436E3/TL-336E3
Die P/N	3S	3E2	3E3
Specifications	AWG 10/8/6 DIN 6/10/16mm ²	AWG 22/20/18/16/14/12/10/8/6 DIN 0.5/0.75/1.0/1.5/2.5/4/6/10/16mm ²	AWG 22/20/18/16/14/12/10 DIN 0.5/0.75/1.0/1.5/2.5/4/6mm ²
Crimping cable size	Pin Terminal Insulated or Non-Insulated Ferrules	Pin Terminal Insulated or Non-Insulated Ferrules	Pin Terminal Insulated or Non-Insulated Ferrules

Item No	TL-532F/TL-432F/TL-236F	TL-532F1/TL-432F1/TL-236F1	TL-536H/TL-436H/TL-336H
Die P/N	2F	2F1	3H
Specifications	AWG 22-18/16-14 DIN 0.5-1.0/1.5-2.5mm ²	AWG 22-18/16-14 Din 0.5-1.0/1.5-2.5mm ²	AWG 22-18/16-14/12-10 Din 0.5-1.0/1.5-2.5/4-6mm ²
Crimping cable size	Insulated Flag Terminal	Non-Insulated Flag Terminal	Insulated Terminal

Item No	TL-536N/TL-436N/TL-336N	TL-536N2/TL-436N2/TL-336N2	TL-536R/TL-436R/TL-336R
Die P/N	3N	3N2	3R
Specifications	AWG 20-18/16-14/12-10/8 DIN 1.5/2.5/6/10mm ² JIS 1.25/2.0/5/8mm ²	AWG 18-16/14/12-10/8 DIN 0.75-1.5/2.5/4-6/10mm ²	AWG 22-18/16-14/12-10 JIS 1.25/2.0/5.5mm ²
Crimping cable size	Non-Insulated Terminal	Non-Insulated Terminal	Vinyl Insulated w/o Copper Sleeve

Professional Crimping Tools Ratchet Type

Item No	TL-536U/TL-436U/TL-336U	TL-536W/TL-436W/TL-336W	TL-536W1/TL-436W1/TL-336W1
Die P/N	3U	3W	3W1
Specifications	Awg 14-22 din 2.5-0.5mm ²	AWG 22-18/16-14/12-10 DIN 0.5-1.0/1.5-2.5/4-6mm ²	AWG 26-16
Crimping cable size	Non-Insulated, Open Barrel & D-sub, V.35 Terminal	Insulated Terminal	Insulated Terminal

Item No	TL-532C5/TL-432C5/TL-236C5	TL-532D/TL-432D/TL-236D	TL-532D1/TL-432D1/TL-236D1
Die P/N	2C5	2D	2D1
Specifications	AWG 24/14 DIN 0.25/2.5mm ²	DIN 25/35/16mm ² AWG 4/2/6	DIN 25/50mm ² AWG 4/1
Crimping cable size	DIN Spec. Open Barrel Terminal	Pin Terminal Insulated or Non-Insulated Ferrules	Pin Terminal Insulated or Non-Insulated Ferrules

Item No	TL-532D2/TL-432D2/TL-236D2	TL-536N1/TL-436N1/TL-336N1	TL-301
Die P/N	2D2	3N1	TL-301 DIE is unchangeable
Specifications	DIN 16/25/35mm ² AWG 6/4/2	DIN 10/16/25mm ² AWG 8/6/4	AWG 22-18/16-14/12-10 DIN 0.5/1.0/1.5/2.5/4-6mm ²
Crimping cable size	Pin Terminal Insulated or Non-Insulated Ferrules	Non-Insulated Terminal	Insulated Terminal

Professional Coaxial Crimping Tools



Die set is riveted on tool and is unchangeable

TL-106 Series
(Non-Ratchet Type)
9" (229mm)



Professional Coaxial Crimping Tools

Item No	TL-106C	TL-H116C	TL-106D	TL-H116D	TL-106E	TL-H116E
Ratchet type	NO	YES	NO	YES	NO	YES
Specifications	.255"/.322" 6.48/8.20mm		.255"/.213"/.068 6.48/5.40/1.72mm		.213"/.322"/.448 5.40/8.20/11.40mm	
Crimping Cable size	RG59,62,6		RG59,62,6		RG58,6,11,213	

Professional Coaxial Crimping Tools

Item No	TL-106P	TL-H116P	TL-106Q	TL-H116Q	TL-106R	TL-H116R
Ratchet type	NO	YES	NO	YES	NO	YES
Specifications	.059"/.386"/.453 2.41/9.80/11.50mm		.324"/.470" 8.23/11.94mm		.480"/.362" 12.19/9.19mm	
Crimping Cable size	F-59,6,11 & UHF-58,8		F-59,6,11,213		F-59,6,11	

Item No	TL-106F	TL-H116F	TL-106G	TL-H116G	TL-106H	TL-H116H
Ratchet type	NO	YES	NO	YES	NO	YES
Specifications	.100"/.322"/.476" 2.54/8.20/12.1mm		.100"/.322"/.448 2.54/8.20/11.40mm		.322"/.359" 8.20/9.12mm	
Crimping Cable size	RG6,11,213		RG6,11,213,Belden 8281		F-59,62,6	

Item No	TL-106S	TL-H116S	TL-106X	TL-H116X	TL-106Z	TL-H116Z
Ratchet type	NO	YES	NO	YES	NO	YES
Specifications	.102"/.406" 2.60/10.30mm		.076"/.338" 1.93/8.60mm		.216"/.324"/.068 5.48/8.22/1.72mm	
Crimping Cable size	UHF-8		TWINAX CONN		RG58,6	

Item No	TL-106L	TL-H116L	TL-106M	TL-H116M	TL-106N	TL-H116N
Ratchet type	NO	YES	NO	YES	NO	YES
Specifications	.100"/.359"/.406" 2.54/9.12/10.30mm		.100"/.359"/.475 2.54/9.12/12.08mm		.133"/.151"/.122"/.188 3.38/3.84/3.10/4.78mm	
Crimping Cable size	F59,6,11 & uhf-58,8		F-59,6,11		ST/SC Fiber optic	

Item No	TL-106QD	TL-H116QD				
Ratchet type	NO	YES				
Specifications	.096"/.410"/.475" 2.44/10.40/12.06mm					
Crimping Cable size	UHF-8,F-11					

Coaxial Cable Stripper

No replacement cassette is needed



TL-7501A
5"(127mm)



Specification:

TL-	Stripper dimension "D"	Stripping distance
7501A	6.4mm	
7501B	4.0mm	
7501C	6.0mm	
7501D	8.0mm	
7501E	12.0mm	
		2-Blades Model RG-174/58/59/62/6 3C/4C/5C(±2.6~±8.0)
		RJ-45 RJ-11/12

Coaxial Cable Stripper

No replacement cassette is needed



TL-7502A
5"(127mm)

Specification:

TL-	Stripper dimension "D" "E"		Stripping distance
	D(mm)	E(mm)	
7502A	8.0mm	4.0mm	3-Blades Model RG-174/58/59/62/6 3C/4C/5C(±2.6~±8.0)
7502B	6.0mm	6.0mm	
7502C	4.0mm	8.0mm	
			RJ-45 RJ-11/12



TL-7500A
5"(127mm)

Specification:

TL-	Description
7500A	UTP/STP, FLAT CABLE STRIPPER & CUTTER

- Light weight, compact, cost-effective stripper, simple to operate.
- Adjustable stripping blade for different insulation thickness, prevents damage of shielding and conductors.
- The cassette can be reversed to change different coaxial cable.
- Easily to adjust with thumb screw.

TL-	Description
352	*Strips outer jacket of UTP and STP cable and CAT-5 round telephone cable *Strips RG59/6/11/7 coaxial cable *Strips flat telephone cable *With cable cutter



TL-352
4.9"(125mm)

Coaxial Cable Stripper 3-Blades Model

○ TL-322 with streamlined design, no replacement cassette is needed and no adjustment for V-Block. Tool has been preset for RG58/59/6.

○ For stripping different materials of cable, use the built-in hex key to align the sensitive socket and adjust the blade for good results.

TL-	For stripping RG cable	Stripping distance
322	RG-58/59/62/6	3 blades model  Fig.1
312A	RG-59/62/6/4C/5C	
312B	RG-58/59/62/3C/4C	
312X	FOR CABLE O.D.FROM 3.56-57mm	
312S 322S3	FOR BIG CABLE O.D.AROUND 10.56 SUCH AS RG-213	



TL-322
4.3''(108mm)



TL-312A/B/S/X
4.3''(108mm)

Coaxial Cable Stripper 2-Blades Model

○ The V-block can be reversed, and the indication arrow*► show recommended cable size. Stripping distance can be changed if user moves one of the stripping blades. (AS FIG.2)

○ Stripping the coaxial jacket and inner conductor in one operation by rotating the stripper in clockwise direction 3-6 times, easy and effective.

○ For stripping different materials of cable, use the built-in hex key to align the sensitive socket and adjust the blade for good results

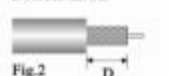
TL-	For stripping RG cable	Stripping distance
332	RG-58/59/62/6/6QS/3C/4C/5C	2 blades model  Fig.2
332A	RG-59/62/6/4C/5C	
332B	RG-58/59/62/3C/4C	
332D	RG-174	
302A	RG-59/62/6/4C/5C	
302B	RG-58/59/62/3C/4C	302 SERIES D=6,8mm
322S	RG-8/11/213	332 SERIES D=4,6,8,12mm



TL-332
3.9''(99mm)



TL-302A/B
4.1''(150mm)

○ Replacement Blade:

TL-302 series: TL-3021, TL-312 series: 3121

TL-332 series: TL-3321, TL-322 series: 3221

○ Special requirement is available.

Coaxial Cable Stripper 2-Blades Model

TL-	For stripping RG cable	Stripping distance
501E	RG59/62/6/11/7/213/8 UTP	2 blades model  RG59/6 D=4mm(1/8") RG59/6 D=6.35mm(1/4") RG11/7 D=6.35mm(1/4")



TL-501E
5.4''(137mm)

- Light weight, compact, cost-effective stripper is simple to operate.
- Stripping the coaxial jacket and inner conductor in one operation by rotating the stripper in clockwise direction 3-6 times, easy and effective.
- No adjustments needed

TL-	For stripping RG cable	Stripping distance
323	RG-59/62/6/11/7/213/8	2 blades model  Fig.2 RG59/6 D=6.35mm(1/4") RG11/7 D=6.35mm(1/4")



TL-323
4.8''(121mm)

Adjusting Cable Slitter

TL-	For stripping RG cable	Stripping distance
325	Plastic	Strip cables from 4.5-25mm (.18"-1.0") diameter
335	Plastic	Strip cables from 25-36mm (1.0"-1.4") diameter

○ Replacement blade: TL-3251



TL-325
6''(150mm)



TL-335
6.6''(167mm)

Multi-function cable stripper

©Sharp SK-2 blade for cutter and stripper can be replaced.

TL-	Description
S501A	For \varnothing wire (UTP/STP) or \square wire and multi conductor cable from 3.2mm-9mm max. Irregular out-shape insulation can be put into the front "V" and "U" guide, rotate the tool 1-3 times by index finger for stripping the outer insulations easily.
S501B	Same as TL-S501A with an additional adjustable knob for fitting different cable sizes.

Body made of ABS and fiber glass.
Replacement blade: TL-200S



TL-S501B
4.8"(122mm)



TL-S501A
4.8"(122mm)



Impact and Punch Down Tool

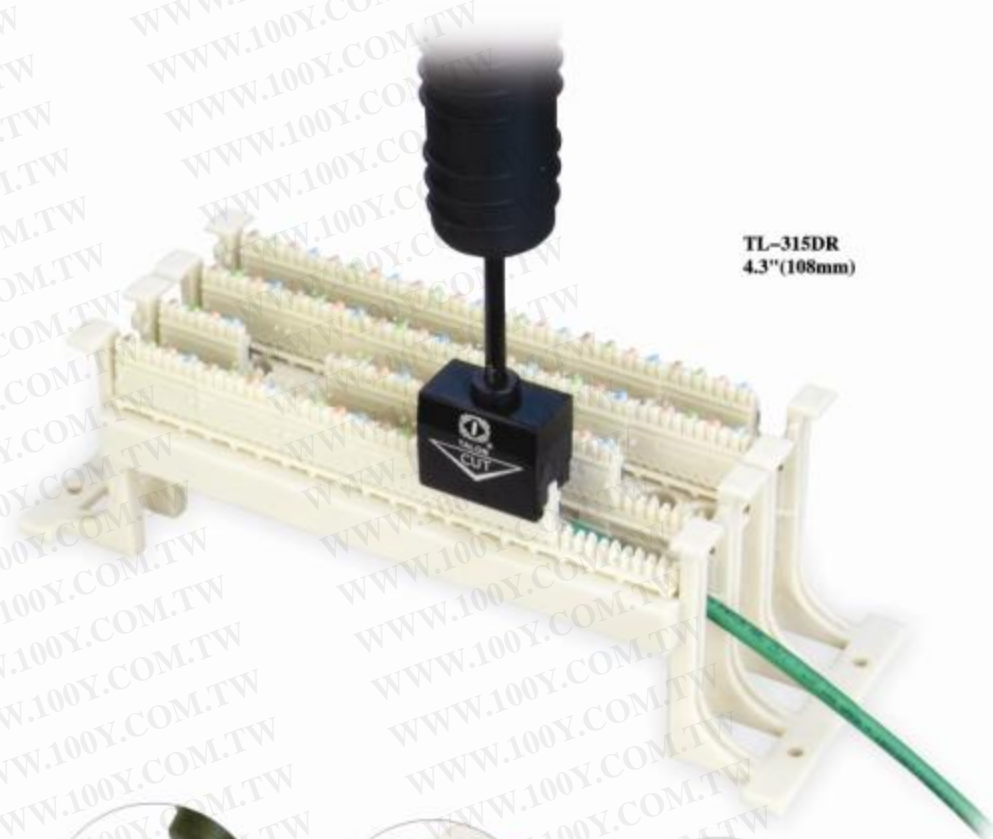

TL-315DR
4.3"(108mm)

Easy Stripper for UTP/STP Telecom Wire

TL-308M	For stripping wire diameter \varnothing 5- \varnothing 6.2mm. Made of poly resin, economic type.
TL-318M	For stripping wire diameter \varnothing 5- \varnothing 6.2mm. top end for 110/88 type insertion use.
TL-328M	For stripping wire diameter \varnothing 5- \varnothing 6.2mm. top end for 110/88 type insertion use.



TL-328M
3.5"(89mm)



TL-318M
7.7"(94mm)



TL-308M
3.2"(82mm)



Impact and Punch Down Tool

TL-315DR 5Pairs 110 Punch Down Tool

- For use on Lan and Telecom, seating 4 or 5 pairs UTP(24 AWG) at a time.
- Suitable for both 110 type cable side and cross-connect side terminals blocks.
- The termination block heel w/blades are changeable and reversible. One end for seating and cutting off wires, and the other end for seating wires only.

TL-	Frame	Blade	For terminal block
315BR	TL-3150R	TL-15B	Use on 110 type (4pairs)
315BKR		TL-15BK	Use on Krone type (4pairs)
315CR		TL-15C	Use on modular jack (4pairs)
315DR		TL-15D	Use on 110 type (5pairs)



TL-315DR
4.3"(108mm)



TL-15C
(4 pairs)
For modular jack

TL-15D
(4 pairs)

TL-15B
(4 pairs)

Multi-Function Modular Jack Termination Tools

- Simplifies the termination process
- Terminates and cuts all 8 conductors at once
- Simplifies lacing process and speeds up termination
- Change the cable manager can be used for 180 and 90 degree modular jack



TL-5088R
9.1"(231mm)



Impact and Punch Down Tool

- With adjustable impact pressure control
- The storage on the top of tool is for storing one piece of spare blade
- Blades are interchangeable and reversible.

Complete Tool	Handle	Blade	For terminal block
TL-314	TL-3140	TL-14 TL-14T	Use on 66 type
TL-314B		TL-14B TL-14TB	Use on 110/88 type
TL-314E		TL-14TE	Use on tyco type
TL-314A		TL-14TA	Use on 66 & 110/88 type
TL-314C		TL-14TC	Use on tyco & krone type
TL-314D		TL-14TD	Use on 630A modular phone type
TL-314TBK		TL-14TBK	Use on krone type
TL-314K		TL-14TK	Use on krone type(w/scissor)
TL-314W		TL-14TW	Use on bix type
TL-314Q		TL-14TQ	Use on Qante type



TL-3140
7.1"(180mm)



Complete Tool	Handle	Blade	For terminal block
TL-324	TL-3240	TL-14 TL-14T	Use on 66 type
TL-324B		TL-14B TL-14TB	Use on 110/88 type
TL-324E		TL-14TE	Use on tyco type
TL-324A		TL-14TA	Use on 66 & 110/88 type
TL-324C		TL-14TC	Use on tyco & krone type
TL-324D		TL-14TD	Use on 630A modular phone type
TL-324BK		TL-14TBK	Use on krone type
TL-324K		TL-14TK	Use on krone type(w/scissor)
TL-324W		TL-14TW	Use on bix type
TL-324Q		TL-14TQ	Use on Qante type



TL-3240
4.5"(114mm)



Blades are made of hardened SNCM -21
All are interchange and reversible

TL-14		TL-14B	
TL-14T		TL-14TC	
TL-14TA		TL-14TE	
TL-14TB		TL-14TQ	
TL-14TBK		TL-14TK	
TL-14TD		TL-14TW	

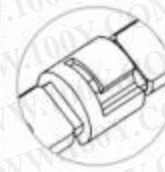

Twist-lock Type

Complete Tool	Handle	Blade	For terminal block
TL-110B	TL-110	TL-14B	Use on 110/88 type



TL-110
7.4"(188mm)

Impact and Punch Down Tool

- TL-9140 series is with impact & adjustable Hi-Lo Pressure selector
- A built-in combination hook/spudger for tracing and removing wires
- Twist-lock style holder provides quick, easy blade changes and prevents pullout an additional safe storage for one more spare blade
- Interchang cable and reversible blades.

Complete Tool	Handle	Blade	For terminal block
TL-914	TL-9140 (Twist-lock type)	TL-14T	Use on 66 tape
TL-914A		TL-14TA	Use on 66 & 110/88 type
TL-914B		TL-14TB	Use on 110/88 type
TL-914BK		TL-14TBK	Use on krone type
TL-914K		TL-14TK	Use on krone type(w/scissor)
TL-914W		TL-14TW	Use on bix type
TL-914Q		TL-14TQ	Use on Qante type
TL-914C		TL-14TC	Use on tuc & krone type
TL-914E		TL-14TE	Use on tyco type
TL-914D		TL-14TD	Use on 630A modular phone jack



TL-9140
5.9"(150mm)

TL-3640 series is non impact type

Complete Tool	Handle	Blade	For terminal block
TL-364	TL-3640 (Twist-lock type)	TL-14T	Use on 66 tape
TL-364A		TL-14TA	Use on 66 & 110/88 type
TL-364B		TL-14TB	Use on 110/88 type
TL-364BK		TL-14TBK	Use on krone type
TL-364K		TL-14TK	Use on krone type(w/scissor)
TL-364W		TL-14TW	Use on bix type
TL-364Q		TL-14TQ	Use on Qante type
TL-364C		TL-14TC	Use on tyco & krone type
TL-364E		TL-14TE	Use on tyco type
TL-364D		TL-14TD	Use on 630A modular phone jack



TL-3640
5.7"(145mm)

Blades are made of hardened SNCM -21
All are interchange and reversible

TL	Description
304	For 110/88 Type insertion use



Twist-lock Type



TL-304
5.5"(140mm)

Impact and Punch Down Tool

- Suitable for connecting cables, modules and distribution frames.
- Various products make the job more convenient.
- Specialty-made tool head ensures durability.
- Combination hook.

TL-	Description
3141A	Use on krone & 110 terminal block
3141B	Use on krone & 110 terminal block
3141	Use on krone & 110 terminal block



TL-3141
7.3"(185mm)



TL-3141A
7.1"(180mm)



TL-3141B
4.8"(122mm)



TL-3130
5.9"(150mm)



TL-314BK
7.3"(185mm)

TL-	Description
314BK	Use on krone & 110 telecom terminal block

TL-	Description
156	Use on telecom terminal block



TL-156
6.1"(155mm)

TL-	Description
3142	Use on telecom terminal block



TL-3142
6.5"(165mm)

Impact and Punch Down Tool

- Works on computer networking/cabling.
- Specially-made toll head ensures durability.

TL-	Description
118	For impact cat 5E modules and patch panel, 8bdn patch panel



TL-118
6.1"(155mm)

- Insertion tool of northern telecom type.
- Spring loaded for seating and removing wires easily

TL-	Description
320	For seating wire into northern telecom terminal block



TL-320
5.7"(144.5mm)

TL-	Description
3143	For impact telecom terminal block



TL-3143
6.4"(162.5mm)

TL-	Description
3144	For impact telecom terminal block



TL-3144
6.1"(155mm)

Cable Stripper

TL-700D

- A versatile wire stripper of sturdy construction capable of cutting and stripping flexible from 0.2 to 4mm, without any adjustment.
- Blade pressure can be adjusted for external sheaths of 3 core cables.
- Also feature a cable cutter.



TL-700D
6.5"(173mm)

TL-	Wire Size	Blade
701A	0.5/1.2/1.5/2.0MM (AWG 24/16/14/12)	
701B	1.0/1.6/2.0/2.6/3.2MM (AWG 18/14/12/10/8)	
701C	22.18-20.14-16.12.10.8 (AWG)	



TL-701A
6.7"(170mm)

TL-	Stripping wire size	
766	AWG	22-10
	mm ²	0.5-6.0



TL-766
8.2"(210mm)

Precise Cutter & Stripper

- ⊙ 6.5" 5 in 1, precise cutter & stripper with comfortable thickness handle.
- ⊙ Made by CNC grinding.
- ⊙ Wire stripper, wire cutter, steel wire cutter, pliers, wire loop with grinding blades for sharp cutter & stripper.
- ⊙ Laser marked gauges including AWG & mm.



TL-5021
6.5"(168mm)

TL-	Applicable for stripping wire size								
5021	AWG	Stranded	12	14	16	18	20	22	24
5021R		Single	10	12	14	16	18	20	22
4021	mm		2.6	2.0	1.6	1.3	1.0	0.8	0.6
5022		AWG	Stranded	16	18	20	22	24	26
5022R	Single		14	16	18	20	22	24	
4022	mm		1.6	1.3	1.0	0.8	0.6	0.5	
5023		AWG	Stranded	22	24	26	28	30	-
5023R	Single		20	22	24	26	28	30	
4023	mm		0.8	0.6	0.5	0.4	0.32	0.25	

Special stripping sizes are welcome.



TL-4021
6.5"(168mm)



TL-5021R
7"(177mm)
with ergonomically
designed handles



TL-1041
6.8"(173mm)

- ⊙ 6.8" 7 in 1 crimping tools.
- ⊙ Wire stripper, wire cutter, steel wire cutter, pliers, wire loop, scale mm & inch, crimping tool.

TL-	Stripping wire size					
1041	AWG	18	16	14	12	10
	mm ²	0.9	1.25	2.0	3.5	5.5
1042	AWG	26,24	22	20	18	16
	mm ²	0.2	0.35	0.5	0.9	1.25
1043	AWG	30	28	26	24	22
	mm ²	0.25	0.52	0.4	0.5	0.65

Terminal Crimping Tool

TL-	Terminal Crimping Tools							
203	AWG	STRANDED	12	14	16	18	20	22
		SINGLE	10	12	14	16	18	20
	MM		2.6	2.0	1.6	1.3	1.0	0.8
			22-18/16-14/12-10					
	DIN mm2	0.5-1.0/1.5-2.5/4-6						

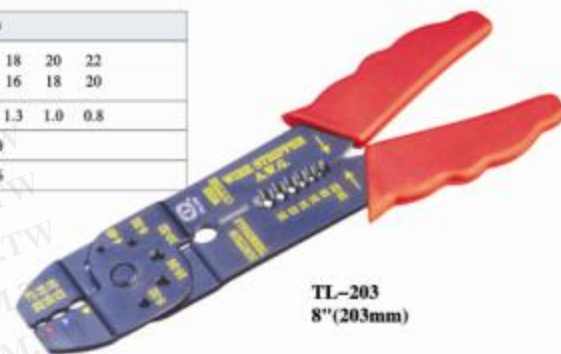

TL-203
8"(203mm)

- ⊙ Crimper made of carbon steel and hardened.

TL-	Stripping wire size						
204	AWG	20	18	16	14	12	10
	MM ²	0.75	0.9	1.25	2.0	3.5	5.5
	AWG	20-18	14-16	12-10			
204	DIN	1.5	2.5	6			
	MM ²						
	JIS	1.25	2	5.5			

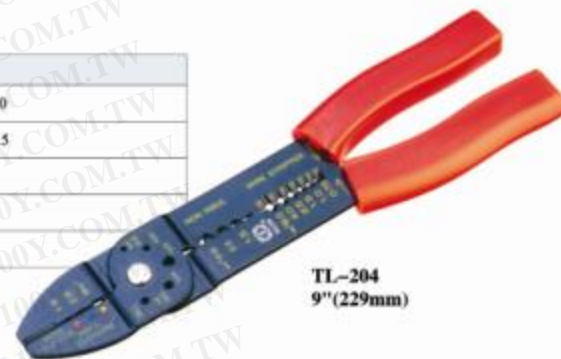

TL-204
9"(229mm)

Precise Cutter & Stripper

- ⊙ 8.3" for all functions precise crimping tool.
- ⊙ M¹ 3.2mm middle carbon steel.
- ⊙ CNC grinding

TL-	Multi purpose tool 8 functions in 1							
205	1.	Cutting solid wire						
	2.	Crimping ins. terminals	10-22AWG	6-0.5mm2				
	3.	Crimping non-ins. terminals	10-22AWG	wire				
	4.	looping	3mm	wire				
	5.	Cutting bolt	4-40, 6-32, 8-32, 10-24, 10-32	(inch size)				
	6.	Cutting	Cu, Al	soft wire				
	7.	Stripping	22-10	AWG wire				
	8.	Crimping	ignition terminals					



TL-205
8.3"(210mm)

Cable Tie Fasten Tool

◎Assembling line use

TL	DESCRIPTION
100	For Cable tie from 2.2 to 4.8mm Width and thickness up to 1.6mm Fasten and automatic cut ties,with Adjustable bundling pressure



TL-100
5.7"(145mm)

◎Heavy duty use
◎With safe stop to prevent from injury

TL	DESCRIPTION
519	For cable tie thickness up to 2.3mm & width up to 9.5mm with single spring loaded and comfortable hand force



TL-519
7.5"(191mm)

◎Assembling line use

TL	DESCRIPTION
600A	For cable tie from 2.2 to 4.8mm Width, and thickness up to 1.6mm Fasten and automatic cut ties, with adjustable bundling pressure



TL-600A
6.3"(160mm)

◎Economic type

TL	DESCRIPTION
2881	For cable tie thickness up to 2.3mm Frame made by steel, harden & black oxide finished



TL-2881
6.8"(165mm)

Telecom Splices Crimping Tool

TL-	Crimping size			
310 Deluxe Type	AWG	19-26 (UR)	22-26 (UY)	19-26 (UG)
311 Economic Type	AWG	19-26 (UR)	22-26 (UY)	19-26 (UG)
998	UAL,UBCO,UYCO,UG,UR,UY,UB UIB,UIY,UIR,UDW,UDM,SUPER-MINI,CROSS			



TL-310
7"(180mm)



TL-311
5.9"(150mm)



TL-998
6.3"(159mm)

Terminal Crimping Tool

◎Frame made of steel with cushion handles
for comfortable operation.

TL-	Crimping insulated terminal size	
1MA	AWG	20-18 16-14
	DIN mm ²	1.5 2.5
	JIS mm ²	1.25 2



TL-1MA
6.7"(170mm)

Terminal Crimping Tool

○Crimper made of carbon steel and hardened

TL-	Crimping insulated terminal size		
864/866	AWG	20-18	16-14
	DIN mm ²	1.5	2.5



TL-864
6.9"(175mm)



TL-866
6.9"(175mm)

Frame made of steel with cushion handles for comfortable operation.

TL-	Crimping insulated terminal size			
8164	AWG	10	8	6
	DIN mm ²	6	10	16
	JIS mm ²	5.5	8	14



TL-8164
8.3"(210mm)



TL-242
9"(229mm)



TL-102H
8"(203mm)

"F" Connector Crimping Tool

○Parallel action

○Surface by nickel plating

TL	For crimping "F" Connector
102H	RG59/62,6 hex type
102O	RG59/62,8 11 oval type
102A	RG59/62,6 oval type
242A	RG59/62,6 hex type
242	RG59 & Aluminum RG6 hex type
242Q	.324"/.360/pin hole hex type

Terminal Crimping Tool

○Frame made of steel with cushion handles for comfortable operation.

TL-	Description
202A	For computer pins & sockets, D-Sub 26-28 AWG wire. For butt-insulated connectors, 22-26 AWG wire. For telephone piercing spade lugs, 22-26 AWG wire. For open barrel connectors, 20-22AWG wire. For open barrel connectors, 14-18 AWG wire.
202B	For computer pins & sockets, D-Sub 26-28 AWG wire. For butt-insulated connectors, 22-26 AWG wire. For telephone piercing spade lugs, 22-26AWG wire. For open barrel connectors, 14-18 AWG wire. For non-insulated terminals,10-14, 16-18 and 20-22 AWG wire.



TL-202A
7.3"(185mm)



TL-202B
7.3"(185mm)



TL-213
6.9"(175mm)

TL-	Description
213	For crimping D-Sub AWG: 20-24-28

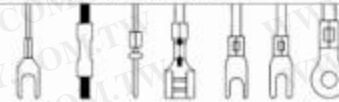

Use tool TL-1091 or TL-223 for stripping wire.

TL-	CRIMPING NON-INS, TERMINAL SIZE		
195A	AWG	20-18	16-14
	DIN mm ²	1.5	2.5
195B	JIS mm ²	1.25	2
	AWG	24-22	20-18 16-14 12-10
195B	DIN mm ²	0.75	1.5 2.5 6
	JIS mm ²	0.5	1.25 2 5.5



TL-195A
7.7"(195mm)

Terminal Crimping Tool

TL-	CRIMPING NON-INS. TERMINAL SIZE				
245A	AWG	20-18	16-14	12-10	8
	DIN mm2	1.5	2.5	6	10
	JIS mm2	1.25	2	5.5	8
245B	AWG	22-20	18-16	14-10	10
	DIN mm2	1.25	2.75	4.5-6.5	12
	JIS mm2	1	2.5	4-6	10



TL-245B
7.65"(245mm)

TL-	CRIMPING NON-INS. TERMINAL SIZE				
270A	AWG	12-10	8	6	
	DIN mm2	6	10	16	
	JIS mm2	5.5	8	14	
270B	AWG	20-18	16-14	12-10	8 6
	DIN mm2	1.5	2.5	6	10 16
	JIS mm2	1.25	2	5.5	8 14



TL-270B
10.6"(270mm)

TL-	CRIMPING NON-INS. TERMINAL SIZE					
354A	AWG	12-10	8	6	4	2
	DIN mm2	6	10	16	25	35
	JIS mm2	5.5	8	14	22	38



TL-354A
13.9"(354mm)

Cable Cutter

TL	For cutting
206	6.5"L cuts wire O.D. up to 0.41"(10.5mm)
330A	8.7"L cuts wire O.D. up to 0.75"(19.1mm)



TL-330A
8.7"(220mm)



TL-206
6.5"(165mm)

TL	Description
A184	For cutting cable RG58, RG59, and RG6 Not for steel component
B184	For cutting cable RG58, RG59, RG6, RG7 Not for steel component
C184	For cutting cable RG58, RG59, RG6, RG7 and RG11 Not for steel component



TL-B184
8.3"(210mm)



TL-A184
6.3"(162mm)



TL-C184
9.2"(235mm)

Cable Cutter

○Made of carbon steel and hardened with blade oxide finished

TL-	For copper cable	For Aluminum cable
A201A	16mm ² Solid 35mm ² Stranded 70mm ² Flexible	70mm ² Stranded



TL-A201A
9.2"(235mm)

Ratchet Cable Cutter With Low Hand Force

- Quick release mechanism simplifies blade back-out.
- Locking mechanism keeps handles closed for easy storage.
- Single speed ratchet mechanism.
- Heavy-duty blades provide long life.

TL-	Description
535A	Cuts up to 350mcm copper,500mcm aluminum power cable. Maximum capacity is 1-3/16"(32mm) dia.or up to 200 pair communications cable.
535B	Cuts up to 500mcm copper,500mcm aluminum power cable. Maximum capacity is 1-3/8"(35mm) dia.or up to 200 pair communications cable.
535C	Cuts up to 600mcm copper,750mcm aluminum power cable. Maximum capacity is 2-1/8"(53mm) dia.or up to 2700 pair telephone cable.



TL-535A
10.0"(260mm)



TL-535B
12.2"(310mm)



TL-535C
13"(330mm)

Heavy Duty Crimping Tool

- The pull off force the various sizes of conductor meets AS/NZS 4325 1:1995 & IEC 1238-1:1993 spec.
- For example:6mm² required 36kgs pull off force,our tool meets 100kgs. 120mm² required 720kgs pull off force,our tool meets 890kgs.

TL-	Hex Size	Length
2515	6,10,16,25,35,50	15.4"(390mm)
2516	6,10,16,25,35,50,70,95,120	24.8"(630mm)
2517	16,25,35,50,70,95,120	24.8"(630mm)
2518	25,35,50,70,95,120,150	24.8"(630mm)
2519	70,95,120,150,240	24.8"(630mm)



TL-2515
15.4"(390mm)



TL-2516
24.8"(630mm)

Pin-Extractor

TL-	Description
224A	Simply lock a F connector into socket it onto a stripped cable end
224D	3 in 1 tool. One end to enlarge space between shield and insulation for RG59,another and for RG 6,the other end lock F connector into tool socket and twist it onto a stripped cable end.



TL-224D
3.93"(100mm)

BNC/F Connector Removal Tool

- For security system use.
- Remove BNC/F connectors in high density or hard-to-reach locations.

TL-	Blade length	BNC	F
2216	16" (410±5mm)	✓	
2212	12" (308±5mm)	✓	
2208	8" (206±5mm)	✓	
2206	6" (156±5mm)	✓	
2216F	16" (410±5mm)		✓
2212F	12" (308±5mm)		✓
2208F	8" (206±5mm)		✓
2206F	6" (156±5mm)		✓



TL-224A
3.7"(94mm)



TL-2206
TL-2208
TL-2212
TL-2216

TL-2206F
TL-2208F
TL-2212F
TL-2216F

Tool Kit

TL-	CRIMPER	STRIPPER	PLUGS	
K500R	500R	S501A	8P8C*30	6P6C*30
K500	500	S501A	8P8C*30	6P6C*30
K568R	568R	S501A	8P8C*30	6P6C*30
K568	568	S501A	8P8C*30	6P6C*30

Box Size:300(L)X220(W)X60(H)mm

TL-	CRIMPER	STRIPPER	PLUGS	OTHERS
K500RT	500R	S501A	8P8C*30	6P6C*30
K500T	500	S501A	8P8C*30	6P6C*30
K568RT	568R	S501A	8P8C*30	6P6C*30
K568T	568	S501A	8P8C*30	6P6C*30

Box Size:300(L)X220(W)X60(H)mm

TL-	CRIMPER	PD TOOL	BLADE	PLUGS
K500RP	500R	3140	14 14B	8P8C*30
K500P	500			6P6C*30
K568RP	568R			8P8C*30
K568P	568			6P6C*30

Box Size:300(L)X220(W)X60(H)mm



TL-K500RP



TL-K568RT



TL-K500R

Tool Kit

TL-	CRIMPER	STRIPPER	PD TOOL	BLADE	PLUGS
K500RS	500R	S501A	3240	14 14B	8P8C*30 6P6C*30
K500S	500				8P8C*30 6P6C*30
K568RS	568R				8P8C*30 6P6C*30
K568S	568				8P8C*30 6P6C*30

Box Size:300(L)X220(W)X60(H)mm

TL-	CRIMPER	COAX STRIPPER	CUTTER	DIE SET
K336	236A	332	206	336C DIE 336G DIE 336J DIE 336K DIE

Box Size:300(L)X220(W)X60(H)mm

TL-	CRIMPER	CUTTER	STRIPPER	PD TOOL	BLADE	COAX STRIPPER	DIE SET	OTHERS
K4015	236A 2008R	206	5021 S501A	3140	14B	332	336C DIE 336G DIE 336J DIE 336K DIE	TESTER SCREW DRIVER

Box Size:350(L)X250(W)X60(H)mm



▲ TL-K336

▶ TL-K500RS



▶ TL-K4015

Tool Kit

TL-	CRIMPER	COAX STRIPPER	CUTTER	CONNECTOR
K518F1	518F1	7501A	206	F*10PCS BNC*10PCS RCA*10PCS

Box Size:300(L)X220(W)X60(H)mm

TL-	CRIMPER	COAX STRIPPER	CONNECTOR
KH510B	H510B	7501A	F*10PCS BNC*10PCS RCA*10PCS

Box Size:300(L)X220(W)X60(H)mm

TL-	CRIMPER	COAX STRIPPER	CONNECTOR
KH548A	H548A	501E	F*30PCS

Box Size:300(L)X220(W)X60(H)mm



▲ TL-K518F1



▶ TL-KH510B



▶ TL-KH548A

Tool Kit

TL-	CRIMPER	COAX STRIPPER	CUTTER	CONNECTOR
K5082R	5082R	7501A	206	F*10PCS BNC*10PCS RCA*10PCS

Box Size:300(L)X220(W)X60(H)mm

TL-	CRIMPER	CABLE STRIPPER	CUTTER	CONNECTOR
K508	508	7501A	206	F*30PCS

Box Size:300(L)X220(W)X60(H)mm

TL-	CRIMPER	STRIPPER	PD TOOL	BLADE	TESTER
K8086R	8086R	7500A	3140	14B	468

Box Size:300(L)X220(W)X60(H)mm



▲ TL-K508



▶ TL-K5082R



▶ TL-K8086R

Tool Kit

TL-	CRIMPER	STRIPPER	PD TOOL	BLADE	PLUGS	TESTER
K315A	315	S501A	3140	14 14B	4P4C*30PCS 6P6C*30PCS 8P8C*30PCS	468
K315B						523

Box Size:350(L)X250(W)X60(H)mm

TL-	CRIMPER	STRIPPER	PD TOOL	BLADE	PLUGS	TESTER
K8500R	500R	S501B	3140	14B	8P8C*30PCS	668

Box Size:300(L)X220(W)X60(H)mm



▶ TL-K315A



▲ TL-K315B



▶ TL-K8500R

Cable Tester

Network Multi-Modular Cable Tester

TL-468: Available for RJ45(UTP/STP) and RJ11 modular cables.

TL-468B: Available for RJ45(UTP/STP) and RJ11, BNC modular cables.



TL-468



TL-468B

Network Multi-Modular Cable Tester

TL-448: Available for RJ45(UTP/STP) and USB modular cables.

TL-428: Available for RJ45(UTP/STP) and BNC modular cables.



TL-448



TL-428

Cable Tester

Network Multi-Modular Cable Tester



▲ TL-668
Available for RJ45(UTP/STP) and RJ11 modular cables.



▲ TL-648
Available for RJ45(UTP/STP) and USB modular cables.



▲ TL-628
Available for RJ45(UTP/STP) and BNC modular cables.

Cable Tester

Network Multi-Modular Cable Tester

TL-568S: Available for RJ45(UTP/STP) and RJ11 modular cables.
 TL-568U: Available for RJ45(UTP/STP) and RJ11 modular cables.



TL-568S



TL-568U

Network Multi-Modular Cable Tester

TL-528: Available for RJ45(UTP/STP) and BNC modular cables.
 TL-5248: Available for RJ45(UTP/STP) and BNC modular cables.



TL-528



TL-5248

Cable Tester

Network Multi-Modular Cable Tester

Available for RJ45(UTP/STP), USB, RJ11/RJ12, BNC, Coaxial, RCA and modular cables.
 Operate with AUTO scan of step by step (TEST) mode.



TL-5448

Network Multi-Modular Cable Tester

Available for RJ45(UTP/STP), USB, RJ11/RJ12, BNC, Coaxial, RCA and modular cables.
 Operate with AUTO scan or step by step (TEST) mode.



TL-228

Network Multi-Modular Cable Tester

Available for RJ45(UTP/STP), USB, RJ11/RJ12, BNC, Coaxial, RCA and modular cables.
 Operate with AUTO scan or step by step (TEST) mode.



TL-2468B

Network Multi-Modular Cable Tester

Available for RJ45(UTP/STP), USB, RJ11/RJ12, BNC, Coaxial, RCA and modular cables.
 Operate with Auto Scan or step by step (TEST) mode.



TL-2468



TL-521

Cable Tester

Network Multi-Modular Cable Tester

- Can be used to test the open circuit, short circuit, across butt joint, separate butt joint and reverse butt joint for 5E / 6E UTP / STP twisted-pair, coaxial-cable and telephong wire.
- Position the error of connection wires.
- Test the connectivity of cable separately.
- The meter in calibration mode can be replaced by foot.
- The testing precision of length is up to 98%.
- Measure the length of cable and determine the point of open circuit.
- Test from 5m to 450m



Network Multi-Modular Cable Tester

- With the verifying function of the "Scanner" it will be vert fast to test the basic physical connecting feature of open and short and cable sequence status on the cables below: 1 the utp computer network cable which adopts the standard of 10 base-T EIA/TIA 568A, EIA/TIA568B, AT & T258A, Token ring; 2 the telepong cable of 2PING/4PIN; 3 other metal connecting cable.



Telecommunication Module & Accessories

10 Pair Disconnection&Connection Module	
Item No.	Description
TL-6001A	10Pairs Disconnection Module
TL-6001B	10Pairs Connection Module

Plastic Material: "PBT" Or "ABS"
When Order, Please Mark The Plastic Material: "PBT" or "ABS"



10 Pair Disconnection&Connection Module(Profile Type)	
Item No.	Description
TL-6002A	10Pairs Disconnection Module
TL-6002B	10Pairs Connection Module

Plastic Material: "PBT" Or "ABS"
When Order, Please Mark The Plastic Material: "PBT" or "ABS"



10 Pair Highband CAT 5 Module	
Item No.	Description
TL-6005A	10Pairs Connection Module

Plastic Material: "PBT"



- It connects the cable which is outside the window with the cable indoor without make any hole on the wall or window.
- The window cable is made by special technology, so the screening data can be over 100DB



TL-6001



10 Pair Disconnection & Connection Module

Item No.	Description
TL-6001A	10Pairs Disconnection Module
TL-6001B	10Pairs Connection Module

Plastic Material: "PBT" Or "ABS"
When Order, Please Mark The Plastic Material: "PBT" or "ABS"



Contact of Disconnection Module



Contact of Connection Module

TL-6002



10 Pair Disconnection & Connection Module (Profile Type)

Item No.	Description
TL-6002A	10Pairs Disconnection Module
TL-6002B	10Pairs Connection Module

Plastic Material: "PBT" Or "ABS"
When Order, Please Mark The Plastic Material: "PBT" or "ABS"



Contact of Disconnection Module



Contact of Connection Module

TL-6003



8 Pair Disconnection & Connection Module

Item No.	Description
TL-6003A	8Pairs Disconnection Module
TL-6003B	8Pairs Connection Module

Plastic Material: "PBT" Or "ABS"
When Order, Please Mark The Plastic Material: "PBT" or "ABS"



Contact of Disconnection Module



Contact of Connection Module

TL-6004

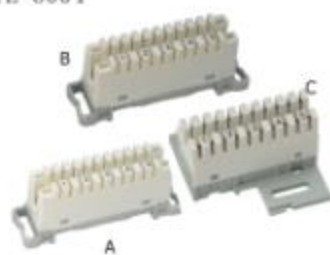

5 Pair Disconnection & Connection Module

Item No.	Description
TL-6004A	5Pairs Disconnection Module
TL-6004B	5Pairs Connection Module
TL-6004C	5Pairs Disconnection Module (Screw Type)

Plastic Material: "PBT" Or "ABS"
When Order, Please Mark The Plastic Material: "PBT" or "ABS"



Contact of Disconnection Module



Contact of Connection Module

TL-6005



10 & 8 Pairs High Band cat. 5 Module

Item No.	Description
TL-6005A	10Pairs High Band Module
TL-6005B	8Pairs High Band Module (With Colour Code)

Plastic Material: "PBT" Or "ABS"
When Order, Please Mark The Plastic Material: "PBT" or "ABS"



Contact of Disconnection Module



Contact of Connection Module

TL-6007



10 Pairs Earth Module (Brown colour)

Item No.	Description
TL-6007A	10Pairs Earth Module
TL-6007B	10Pairs Earth Module (Profile Type)

Plastic Material: "PBT" Or "ABS"
When Order, Please Mark The Plastic Material: "PBT" or "ABS"



Contact of Disconnection Module



Contact of Connection Module

TL-6008



Mounting Frame

Item No.	Description
TL-6008A	For 10Pairs Module (From 1 To 41 Ways)
TL-6008B	For 8Pairs Module (From 1 To 41 Ways)
TL-6008C	For 5Pairs Module (From 1 To 41 Ways)

Material: Stainless Steel
* When Order, Please Mark: With Or Without Rubbering On Both Side Of Mounting Frame
Our Standard Size: H1-20mm, H2-30mm
* We Can Produce Other Size of H2 (For Example: 22mm, 50mm...)

TL-6009



Mounting Frame With Plastic Fitting

Item No.	Description
TL-6009A	With 11Way Frame
TL-6009B	With 27Way Frame
TL-6009C	Plastic Fitting

TL-6010



19 Inch Mounting Bracket

Item No.	Description
TL-6010	For 10 Pair Profile Module

With 4 Set Of Screw & Nut
To Be Fixed On 19inch Cabinet

TL-6011



Earth Bar

Item No.	Description
TL-6011A	For 10 Pairs Module
TL-6011B	For 8 Pairs Module

For Grounding When Single Line Protector Is Operating

TL-6012



150 Pairs Mounting Frame For 19" Cabinet

Item No.	Description
TL-6012	150 Pairs Mounting Frame For 19" Cabinet

Material: Stainless Steel

TL-6013



150 Pairs Mounting Frame For 19" Cabinet

Item No.	Description
TL-6013	150 Pairs Mounting Frame For 19" Cabinet

Material: Stainless Steel

TL-6014

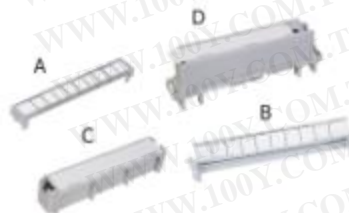

Hinged Label Holder

Item No.	Description
TL-6014A	For 10 Pairs Module
TL-6014B	For 10 Pairs Module (With Double Side Label)
TL-6014C	Label Holder For Mounting Frame
TL-6014D	Label Holder For Profile Frame

TL-6015



1 Pair Dummy Plug

Item No.	Description
TL-6015	Colour: Red, Green, Black, Blue, White, Yellow, Grey

Only Mark On The Module, Can't Open 1Pair Contact Of Disconnection Module

TL-6016



1 Pair Disconnection Plug

Item No.	Description
TL-6016	Colour: Red, Green, Black, Blue, White, Yellow, Grey

Can Open 1Pair Contact Of Disconnection Module

TL-6017



1 Wire Marking Cap

Item No.	Description
TL-6017	Colour: Red, Green, Black, Blue, White, Yellow, Grey

TL-6018

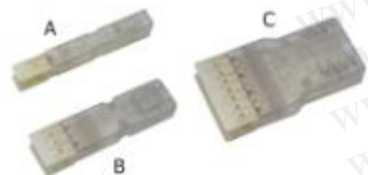

110 Plug	
Item No.	Description
TL-6018A	1 Pairs Plug
TL-6018B	2 Pairs Plug
TL-6018C	4 Pairs Plug

TL-6019



Test Plug	
Item No.	Description
TL-6019A	2P Test Plug
TL-6019B	4P Test Plug

TL-6020



Test Cable With Alligator Clip	
Item No.	Description
TL-6020A	2 Pole Test Cable With Alligator Clip
TL-6020B	4 Pole Test Cable With Alligator Clip

Length: 1.5M Or As Per Request

TL-6021



Test Cable With Modular Plug	
Item No.	Description
TL-6021A	2P Test Cable With 6P2C Plug
TL-6021B	4P Test Cable With 6P4C Plug

Length: 1.5M Or As Per Request

TL-6022



Lightning Protector Unit	
Item No.	Description
TL-6022A	Lightning Protector Unit
TL-6022B	Lightning Protector Unit

- With 3P Arrester(DC Spark-over Voltage:230V or 350V)
- Specially designed in single unit for protecting lines individually. Protects the desired quantity of lines. In case one of them burns out, It is easily replaceable without any disturbance to other protectors and lines. Whenever there is an overvoltage on the line due to lightning strike, The protection unit will clamp down the voltage immediately.

TL-6023



Lightning Protector Unit	
Item No.	Description
TL-6023A	Lightning Protector Unit
TL-6023B	Lightning Protector Unit

- With 3P Arrester(DC Spark-over Voltage:230V)
- Specially designed in single unit for protecting lines individually. Protects the desired quantity of lines. In case one of them burns out, It is easily replaceable without any disturbance to other protectors and lines. Whenever there is an overvoltage on the line due to lightning strike, The protection unit will clamp down the voltage immediately.

TL-6024



3 Pole Arrester Magazine	
Item No.	Description
TL-6024A	10 Pairs(Without Arrester)
TL-6024B	8 Pairs(Without Arrester)
TL-6024C	5 Pairs(Without Arrester)
TL-6024D	10 Pairs(With 10PCS Arrester)
TL-6024E	8 Pairs(With 8PCS Arrester)
TL-6024F	5 Pairs(With 5PCS Arrester)

When Order, Please Mark: With Or Without 3P Arrester(230V)

TL-6025



2 Pole Arrester Magazine	
Item No.	Description
TL-6025A	10 Pairs(Without Arrester)
TL-6025B	8 Pairs(Without Arrester)
TL-6025C	5 Pairs(Without Arrester)
TL-6025D	10 Pairs(With 10PCS Arrester)
TL-6025E	8 Pairs(With 8PCS Arrester)
TL-6025F	5 Pairs(With 5PCS Arrester)

When Order, Please Mark: With Or Without 2P Arrester(230V)

TL-6026



10 Pair Spin-clutch(cross-connection) Module

Item No.	Description
TL-6026	142mmx3mmx19mm

TL-6027



1Pair STB Module (Dropwire) With Protector

Item No.	Description
TL-6027	With Protector (230V)

- * For Dropwire
- * Housing Material: Polycarbonate
- * Insertion Contact: Phosphor Bronze
- * Conductor Diameter: 0.4 To 1.2mm
- * Overall Insulating Diameter: 5mm Maximum

TL-6028



1Pair STB Module (Dropwire) Without Protector

Item No.	Description
TL-6028	Without Protector

- * For Dropwire
- * Housing Material: Polycarbonate
- * Insertion Contact: Phosphor Bronze
- * Conductor Diameter: 0.4 To 1.2mm
- * Overall Insulating Diameter: 5mm Maximum

TL-6029



Distribution Box For STB Module

Item No.	Description
TL-6029A	Without STB Module (Empty)
TL-6029B	With 4PCS STB Module (WT-1043V)
TL-6029C	With 8PCS STB Module (WT-1043D)

- * Plastic Material: ABS Or PC
- * Water Proof Type

TL-6030



Outdoor Box For STB Module

Item No.	Description
TL-6030A	Without STB Module (Empty)
TL-6030B	With 10PCS STB Module (TL-6027)
TL-6030C	With 10PCS STB Module (TL-6028)

- * Plastic Material: PC
- * Water Proof Type
- * Suitable For Outdoor

TL-6031



Outdoor Box For STB Module

Item No.	Description
TL-6031A	Without STB Module (Empty)
TL-6031B	With 10PCS STB Module (TL-6027)
TL-6031C	With 10PCS STB Module (TL-6028)

- * Plastic Material: PC
- * Suitable For Outdoor

TL-6032



Outdoor Box For STB Module

Item No.	Description
TL-6032A	Without STB Module (Empty)
TL-6032B	With 20PCS STB Module (TL-6027)
TL-6032C	With 20PCS STB Module (TL-6028)

- * Plastic Material: PC
- * Water Proof Type
- * Suitable For Outdoor

TL-6033



Metal Box

Item No.	Description
TL-6033A	For 10 Pair Profile Module (1PC TL-6002)
TL-6033B	For 20 Pair Profile Module (2PCS TL-6002)

TL-6034



10 Pairs Distribution Box With Module

Item No.	Description
TL-6034	10 Pairs Distribution Box With Module

- Size: L=163mm, W=83mm, H=31mm
- Plastic Material: ABS

TL-6035



20 Pairs Distribution Box With Module

Item No.	Description
TL-6035	20 Pairs Distribution Box With Module

- Size: L=165mm, W=120mm, H=40mm
- Plastic Material: ABS

TL-6036



30 Pairs Distribution Box

Item No.	Description
TL-6036	30 Pairs Distribution Box

- Size: L=150mm, W=105mm, H=55mm
- Plastic Material: ABS

TL-6037



30 Pairs Distribution Box

Item No.	Description
TL-6037A	Key lock type
TL-6037B	Screw lock type

- Size: L=250mm, W=190mm, H=95mm
- Waterproof type
- Material: PC
- Suitable for indoor or outdoor

TL-6038



50 Pairs Distribution Box

Item No.	Description
TL-6038A	Key lock type
TL-6038B	Screw lock type

- Size: L=195mm, W=195mm, H=85mm
- Waterproof type
- Material: PC
- Suitable for indoor or outdoor

TL-6039



100 Pairs Distribution Box

Item No.	Description
TL-6039A	Key lock type
TL-6039B	Screw lock type

- Size: L=250mm, W=190mm, H=95mm
- Waterproof type
- Material: PC
- Suitable for indoor or outdoor

TL-6040



Distribution Box

Item No.	Description
TL-6040A	30 Pairs
TL-6040B	60 Pairs

- Size: L=175mm, W=165mm, H=75mm
- Plastic Material: ABS

TL-6041



100 Pairs Distribution Box

Item No.	Description
TL-6041	Key lock type

- Size: L=275mm, W=205mm, H=105mm
- Plastic material: ABS
- Key lock type
- Suitable for indoor

TL-6042



10 Pairs Distribution Box With Module

Item No.	Description
TL-6042	30PAIRS(L=140mm, W=117mm, H=75mm)

- Key or screw lock type are optional
- When order, please mark: key or screw lock
- Plastic material: ABS
- Suitable for indoor

TL-6046



10 Pairs Distribution Box With Module

Item No.	Description
TL-6046	Key lock type

- SIZE: L=203mm, W=190mm, H=105mm
- Key Lock Type
- Plastic material: ABS
- Suitable for indoor

TL-6043



10 Pairs Distribution Box With Module

Item No.	Description
TL-6043	50PAIRS(L=216mm, W=216mm, H=75mm)

- Key or screw lock type are optional
- When order, please mark: key or screw lock
- Plastic material: ABS
- Suitable for indoor

TL-6047



Distribution Box

Item No.	Description
TL-6047A	30 Pairs
TL-6047B	50 Pairs

- Size: L=175mm, W=165mm, H=93mm
- Plastic Material: ABS
- Suitable for indoor
- The box are designed to be higher than standard to make the box enough high, so that the box can be fixed with 10pairs arrester module

TL-6044



10 Pairs Distribution Box With Module

Item No.	Description
TL-6044	100PAIRS(L=330mm, W=216mm, H=75mm)

- Key or screw lock type are optional
- When order, please mark: key or screw lock
- Plastic material: ABS
- Suitable for indoor

TL-6048



100 Pairs Distribution Box

Item No.	Description
TL-6048A	100Pairs (H=380mm, W=280mm, D=130mm)
TL-6048B	200Pairs (H=500mm, W=450mm, D=130mm)
TL-6048C	300Pairs (H=600mm, W=450mm, D=130mm)
TL-6048D	400Pairs (H=700mm, W=450mm, D=130mm)
TL-6048E	600Pairs (H=900mm, W=450mm, D=130mm)
TL-6048F	1000Pairs (H=700mm, W=1000mm, D=130mm)
TL-6048G	1200Pairs (H=900mm, W=1000mm, D=130mm)

- Key lock type
- The metal box are used to be mounted on the wall
- The metal material: cold rolled steel
- The thickness of steel: 0.9mm

TL-6045



10 Pairs Distribution Box With Module

Item No.	Description
TL-6045	Key lock type

- SIZE: L=203mm, W=190mm, H=105mm
- Key Lock Type
- Plastic material: ABS
- Suitable for indoor

TL-6049



DISTRIBUTION METAL BOX (WALL MOUNT TYPE)

Item No.	Description
TL-6049A	100Pairs (H=380mm, W=280mm, D=130mm)
TL-6049B	200Pairs (H=500mm, W=450mm, D=130mm)
TL-6049C	300Pairs (H=600mm, W=450mm, D=130mm)
TL-6049D	400Pairs (H=700mm, W=450mm, D=130mm)
TL-6049E	600Pairs (H=900mm, W=450mm, D=130mm)
TL-6049F	1000Pairs (H=700mm, W=1000mm, D=130mm)
TL-6049G	1200Pairs (H=900mm, W=1000mm, D=130mm)

- Key lock type
- The metal box are used to be mounted on the wall
- The metal material: cold rolled steel
- The thickness of steel: 0.8mm

TL-6050



Metal Cabinet

Item No.	Description
TL-6050A	With 1200 Pairs Mounting Frame
TL-6050B	With 2400 Pairs Mounting Frame

- Waterproof Grade: IP65
- Metal Material: Cold Rolled Steel
- Size For Cabinet (without bottom): H=1000mm, W=1000mm, D=310mm
- Size For Bottom: H=400mm, W=700mm, D=200mm
- Total height of cabinet: 1400mm
- Suitable to be fixed with 10size rack (max 200PCS)
- The cabinet has 2 1/2 Floor Steel (side door, front door, back door and top part) the material of the floor insulation are filled between 2 floor steel, to make inside temperature of cabinet insulating from outside
- The thickness of top cabinet floor metal: 0.2mm, the thickness of the inside floor metal: 0.8mm

TL-6051



SMC Cabinet

Item No.	Description
TL-6051A	With 1200 Pairs Mounting Frame
TL-6051B	With 2400 Pairs Mounting Frame

- Water proof Grade: IP65
- Environment temperature: -10°C ~ 60°C
- Material: SMC
- Size for cabinet (without bottom): H=1000mm, W=700mm, D=270mm
- Size for bottom: H=345mm, W=750mm, D=270mm
- Total height of cabinet: 1345mm
- Suitable to be fixed with 10size rack (max 200PCS)

Item Photo Termination Insulation Conductor Item No Code



1.52mm

0.4-0.7mm

TL-K1

UY



1.52mm

0.4-0.7mm

TL-K2

UY2



1.67mm

0.4-0.9mm

TL-K3

UR



1.67mm

0.4-0.9mm

TL-K5

UG



1.27mm

0.4-0.7mm

TL-K4

UB



2.0-3.3mm

Iron 1.2-1.5mm

TL-K6

UIB

TL-7001



Network modul

Item No.	Description
TL-7001	Cat.5E RJ45 Keystone Jack (Without Dust Cover)

Almond Colour
110 IDC

TL-7005



Network modul

Item No.	Description
TL-7005	Cat.6 RJ45 Keystone Jack

TL-7002



Telephone modul

Item No.	Description
TL-7002A	Cat.3 RJ11(6P4C)Keystone Jack
TL-7002B	Cat.3 RJ12(6P4C) Keystone Jack

TL-7006



Network modul

Item No.	Description
TL-7006	Cat.6 RJ45 Keystone Jack

110 IDC

TL-7003



Telephone modul

Item No.	Description
TL-7003A	Cat.3 RJ11(6P4C)Keystone Jack
TL-7003B	Cat.3 RJ12(6P4C) Keystone Jack

Toolless Type

TL-7007



Network modul

Item No.	Description
TL-7007	Cat.6 RJ45 Keystone Jack

110,15c

TL-7004



Network modul

Item No.	Description
TL-7004A	Cat.3 RJ11(6P4C)Keystone Jack
TL-7004B	Cat.3 RJ12(6P4C) Keystone Jack

Toolless Type

TL-7008



Network modul

Item No.	Description
TL-7008A	Cat.5E RJ45 Keystone Jack
TL-7008B	Cat.6 RJ45 Keystone Jack

Dual IDC

TL-7009

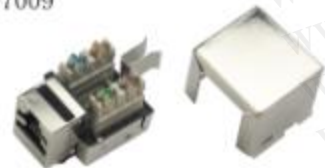

Network modul	
Item No.	Description
TL-7009	Cat. 5E STP RJ45 Keystone Jack

TL-7013



Network modul	
Item No.	Description
TL-7013	Cat. 5E RJ45 Keystone Jack

TL-7010



Network modul	
Item No.	Description
TL-7010	Cat. 5E RJ45 Keystone Jack

TL-7014



Network modul	
Item No.	Description
TL-7014A	Cat. 5E RJ45 Keystone Jack
TL-7014B	Cat. 3 RJ11(6P4C) Keystone Jack

TL-7011



Network modul	
Item No.	Description
TL-7011	Cat. 5E RJ45 Keystone Jack

TL-7015



Network modul	
Item No.	Description
TL-7015	Cat. 5E RJ45 Keystone Jack

TL-7012



Network modul	
Item No.	Description
TL-7012A	Cat. 5E RJ45 Keystone Jack
TL-7012B	Cat. 3 RJ11(6P4C) Keystone Jack

TL-7016



Telephone modul	
Item No.	Description
TL-7016	Cat. 3R RJ45 Keystone Jack

TL-7017



Network modul	
Item No.	Description
TL-7017	Cat. 5E RJ45 Surface Jack
Single Port	

TL-7021



Network Faceplate	
Item No.	Description
TL-7021A	Single port
TL-7021B	Dual Port

- Size: 86 x 86mm
- Suitable For RJ45 Keystone Jack

TL-7018



Network modul	
Item No.	Description
TL-7018	Cat. 5E RJ45 Surface Jack
Dual Ports	

TL-7022



Network Faceplate	
Item No.	Description
TL-7022A	Single port
TL-7022B	Dual Port

- Size: 86 x 86mm
- Suitable For RJ45 Keystone Jack

TL-7019



Network modul	
Item No.	Description
TL-7019	Cat. 5E SFP RJ45 Surface Jack
Single Port	

TL-7023



Network Faceplate	
Item No.	Description
TL-7023A	Single port
TL-7023B	Dual Port

- Size: 86 x 86mm
- Suitable For RJ45 Keystone Jack

TL-7020



Network modul	
Item No.	Description
TL-7020	Cat. 5E SFP RJ45 Keystone Jack
Dual Ports	

TL-7024



Network Faceplate	
Item No.	Description
TL-7024A	Single port
TL-7024B	Dual Port

- Size: 86 x 86mm
- Suitable For RJ45 Keystone Jack

TL-7025



Network Faceplate

Item No.	Description
TL-7025A	Single port
TL-7025B	Dual Port

*Size: 86 x 86mm
 *Suitable For RJ45 Keystone Jack

TL-7029



Network Faceplate

Item No.	Description
TL-7029	Inclined outlet panel

TL-7026



Network Faceplate

Item No.	Description
TL-7026A	Single port
TL-7026B	Dual Port

*Size: 86 x 86mm
 *Suitable For RJ45 Keystone Jack

TL-7030



Network Faceplate

Item No.	Description
TL-7030A	Single Port
TL-7030B	Dual Port

*Suitable For RJ45 Keystone Jack

TL-7027



Network Faceplate

Item No.	Description
TL-7027	86 type outlet panel

TL-7031



Telephone Faceplate

Item No.	Description
TL-7031	Face plate RJ11 2Port

TL-7028



Network Faceplate

Item No.	Description
TL-7028	86 type outlet panel

TL-7032



Telephone Faceplate

Item No.	Description
TL-7032	Face plate RJ11 Single Port

TL-7033



Network Faceplate

Item No.	Description
TL-7033A	Single port
TL-7033B	Dual Port

Size: 86 x 86mm
 Suitable For RJ45 Keystone Jack

TL-7037



Network Faceplate

Item No.	Description
TL-7037	Bottom base box

TL-7034



Network Faceplate

Item No.	Description
TL-7034A	Single port
TL-7034B	Dual Port

Bevel Face plate Suitable For RJ45 Keystone Jack

TL-7038



16 Port Cat. 5E Patch Panel

Item No.	Description
TL-7038	16 Port Cat. 5E Patch Panel

TL-7035



Network Faceplate

Item No.	Description
TL-7035	Suitable For RJ45 Keystone Jack

TL-7039



24 & 48 Port Cat. 5E/6 Patch Panel

Item No.	Description
TL-7039A	24 Port Cat. 5E Patch Panel
TL-7039B	48 Port Cat. 5E Patch Panel
TL-7039C	24 Port Cat. 6 Patch Panel
TL-7039D	48 Port Cat. 6 Patch Panel

TL-7036



Network Faceplate

Item No.	Description
TL-7036	Suitable For RJ45 Keystone Jack

TL-7040



24 & 48 Port Cat. 5E/6 Patch Panel

Item No.	Description
TL-7040A	24 Port Cat. 5E Patch Panel
TL-7040B	48 Port Cat. 5E Patch Panel
TL-7040C	24 Port Cat. 6 Patch Panel
TL-7040D	48 Port Cat. 6 Patch Panel

TL-7041



24 & 48 Port Cat. 5E/6 Patch Panel

Item No.	Description
TL-7041A	24 Port Cat. 5E Patch Panel
TL-7041B	48 Port Cat. 5E Patch Panel
TL-7041C	24 Port Cat. 6 Patch Panel
TL-7041D	48 Port Cat. 6 Patch Panel

TL-7045



48 Port Cat. 5E Patch Panel

Item No.	Description
TL-7045	48 Port Cat. 5E Patch Panel

* 110 IDC

TL-7042



25 Port Cat. 3 Telephone Patch Panel

Item No.	Description
TL-7042	25 Port Cat. 3 Telephone Patch Panel

- * Usual Colour: Black
- * Light Grey (Colour Code: RAL7035) is Optional

TL-7046



24 Port Cat. 6 Patch Panel

Item No.	Description
TL-7046	24 Port Cat. 6 Patch Panel

* 110 IDC

TL-7043



50 Port Cat. 3 Telephone Patch Panel

Item No.	Description
TL-7043	50 Port Cat. 3 Telephone Patch Panel

- * Usual Colour: Black
- * Light Grey (Colour Code: RAL7035) is Optional

TL-7047



48 Port Cat. 6 Patch Panel

Item No.	Description
TL-7047	48 Port Cat. 6 Patch Panel

* 110 IDC

TL-7044



24 Port Cat. 5E Patch Panel

Item No.	Description
TL-7044	24 Port Cat. 5E Patch Panel

* 110 IDC

TL-7048



24 Port Cat. 5E Patch Panel

Item No.	Description
TL-7048	24 Port Cat. 5E Patch Panel

* 110 IDC

TL-7049



48 Port Cat. 5E Patch Panel

Item No.	Description
TL-7049	48 Port Cat. 5E Patch Panel

* 110 IDC

TL-7050



24 Port Cat. 6 Patch Panel

Item No.	Description
TL-7050	24 Port Cat. 6 Patch Panel

* 110 IDC

TL-7051



48 Port Cat. 6 Patch Panel

Item No.	Description
TL-7051	48 Port Cat. 6 Patch Panel

* 110 IDC

TL-7052



16/32 Port Metal Frame

Item No.	Description
TL-7052A	16 Port Patch Panel
TL-7052B	32 Port Patch Panel

* Suitable For RJ45 Keystone Jack

TL-7053



12 Port Cat. 5E Patch Panel (Wall-Mount type)

Item No.	Description
TL-7053	With Plastic Frame

* Dual IDC

TL-7054



24 Port Cat. 5E Patch Panel

Item No.	Description
TL-7054	24 Port Cat. 6 Patch Panel

* 110 IDC

TL-7055



24 Port UTP Cat. 5E Patch Panel

Item No.	Description
TL-7055	24 Port UTP Cat. 5E Patch Panel

TL-7056



24 Port STP Cat. 5E (Cat. 6) Patch Panel

Item No.	Description
TL-7056A	24 Port STP Cat. 5E Patch Panel
TL-7056B	24 Port STP Cat. 6 Patch Panel

* Dual Colour: Black

* Light Grey (Colour Code: RAL7035) is Optional

Patch Panel

TL-7057



24 & 48 Port Cat. 5E&6 Patch Panel	
Item No.	Description
TL-7057A	24 Port Cat. 5E Patch Panel
TL-7057B	48 Port Cat. 5E Patch Panel
TL-7057C	24 Port Cat. 6 Patch Panel
TL-7057D	48 Port Cat. 6 Patch Panel

TL-7058



24 & 48 Port Cat. 5E&6 Patch Panel	
Item No.	Description
TL-7058A	24 Port Cat. 5E Patch Panel
TL-7058B	48 Port Cat. 5E Patch Panel
TL-7058C	24 Port Cat. 6 Patch Panel
TL-7058D	48 Port Cat. 6 Patch Panel

TL-7059



Cable Manager	
Item No.	Description
TL-7059	Cable Manager

* With Metal Cover

TL-7060



Cable Manager	
Item No.	Description
TL-7060	2U Cable Manager

* With 4 Pcs Metal Ring

TL-7061



Cable Manager	
Item No.	Description
TL-7061	2U Cable Manager

* With Metal Cover

TL-7062



Cable Manager	
Item No.	Description
TL-7062	Cable Manager

* With 5 Pcs Plastic Ring

TL-7063



Cable Manager	
Item No.	Description
TL-7063A	With Metal Cover (Metal)
TL-7063B	With Plastic Cover (Plastic)

TL-7064



Cable Manager	
Item No.	Description
TL-7064A	With 4Pcs Metal Ring
TL-7064B	With 5Pcs Metal Ring

TL-7065



Cable Manager	
Item No.	Description
TL-7065	Cable Manager

* Usual Colour: Black
 * Light Grey (Colour Code: RAL7035) is Optional

TL-7069



Wiring Manager	
Item No.	Description
TL-7069	Wiring Manager

TL-7066



Entry Panel	
Item No.	Description
TL-7066	19 Inch Entry Panel

TL-7070



19 Inch Wiring Manager	
Item No.	Description
TL-7070	19 Inch Wiring Manager

TL-7067



Blank Panel	
Item No.	Description
TL-7067A	1U Blank Panel
TL-7067B	2U Blank Panel

TL-7071



19 Inch Wiring Panel	
Item No.	Description
TL-7071	100Pair(1U)

TL-7068



Cable Manager	
Item No.	Description
TL-7068	Cable Manager

* With 5 Pcs Plastic Ring

TL-7072



19 Inch Wiring Panel	
Item No.	Description
TL-7072	200Pair(1U)

* With 485Pairs 110 IDC

TL-7073



Wiring Block -110 Type(Without Legs)

Item No.	Description
TL-7073A	50 Pairs
TL-7073B	100 Pairs

TL--7074



Wiring Block(110 Type)

Item No.	Description
TL-7074A	50 Pairs
TL-7074B	100 Pairs

- With Label Holder
- With 4 & 5 Pair "110" IDC

TL--7075



Cable Manager

Item No.	Description
TL-7075	Cable Manager

- With 5 Pcs Plastic Ring

TL--7076



Cable Manager

Item No.	Description
TL-7076	Cable Manager

- With 5 Pcs Plastic Ring

TL-7075



ITEM NO	Width	Depth	Capacity(U)	Colour	Packing Type	Thickness of steel
TL-7075	600mm	600mm 800mm 1000mm	18U, 20U, 22U, 24U, 26U, 28U, 30U, 32U Other Capacity(U) As Per Customer's Request	*Light Grey *Black	*Whole Package *Flat Package	Mounting Rail:1.5mm Frame of Front Door:1.5mm Others:1.2mm or 1.0mm

- Material: Cold Rolled Steel
- Toughened Glass For Front Door
- Maximum Static Carrying capacity: 500kg
- Whole Package: The Cabinet Have Been Installed, The Whole Cabinet Are Packed Into One Outer-Carton Flat Package, The Cabinet Is Disassembled And Packed Into 2 Or 3 Outer Carton
- The Volume Of Flat Package Is Smaller Than Whole Package, Half Volume Of Whole Package, But Customer Have To Assemble The Cabinet After Receipt
- Standard Attached Accessories:
 - 1. With Screw And Nut
 - 2. With 2Pcs Of Fixed Shelf
 - 3. With 2Pcs Of Fan For 600x600mm Cabinet
 - 4. With 3Pcs Of Fan For 600x800mm, 600x1000mm Cabinet
 - 5. With 1Pc Power Panel (Refer To: WT-2081, WT-2082)
- When Order, Necessary Information Following:
 1. The Capacity (U) Of Cabinet: 18, 20, 22, 24, 26, 28, 30, 32
 2. Size Of Cabinet: 600x600mm, 600x800mm, 600x1000mm
 3. The Colour of Cabinet: Light Grey or Black
- If you order WT-2048, Please Let Us The Colour Of The Front Door, Dark Grey Colour Or The Same Colour As Cabinet's Body.
- Packing Type: Whole Package or Flat Package
- Other Optional Accessories:
 1. Sliding Shelf
 2. Others As Per Customer's Request
- The Key Lock Of Two Side Door Are Selective As Per Customer's Request

TL-7076



ITEM NO	Width	Depth	Capacity(U)	Colour	Packing Type	Thickness of steel
TL-7076	600mm	600mm 800mm 1000mm	18U, 20U, 22U, 24U, 26U, 28U, 30U, 32U Other Capacity(U) As Per Customer's Request	*Light Grey *Black	*Whole Package *Flat Package	Mounting Rail:1.5mm Frame of Front Door:1.5mm Others:1.2mm or 1.0mm

- Material: Cold Rolled Steel
- Toughened Glass For Front Door
- Maximum Static Carrying capacity: 500kg
- Whole Package: The Cabinet Have Been Installed, The Whole Cabinet Are Packed Into One Outer-Carton Flat Package, The Cabinet Is Disassembled And Packed Into 2 Or 3 Outer Carton
- The Volume Of Flat Package Is Smaller Than Whole Package, Half Volume Of Whole Package, But Customer Have To Assemble The Cabinet After Receipt
- Standard Attached Accessories:
 - 1. With Screw And Nut
 - 2. With 2Pcs Of Center And Adjuster With 2Pcs Of Fixed Shelf
 - 3. With 2Pcs Of Fan For 600x600mm Cabinet
 - 4. With 3Pcs Of Fan For 600x800mm, 600x1000mm Cabinet
 - 5. With 1Pc Power Panel (Refer To: WT-2081, WT-2082)
- When Order, Necessary Information Following:
 1. The Capacity (U) Of Cabinet: 18, 20, 22, 24, 26, 28, 30, 32
 2. Size Of Cabinet: 600x600mm, 600x800mm, 600x1000mm
 3. The Colour of Cabinet: Light Grey or Black
- Packing Type: Whole Package or Flat Package
- Other Optional Accessories:
 1. Sliding Shelf
 2. Others As Per Customer's Request
- The Key Lock Of Two Side Door Are Selective As Per Customer's Request

ITEM NO	Width	Depth	Capacity (U)	Thickness of steel	Colour	Fan
TL-7077A	600mm	450mm	4U, 6U, 9U, 12U, 15U	Mounting Rail:1.2mm Frame of Front Door:1.2mm Others:1.0mm	*Light Grey *Black	*With 1 Fan
TL-7077B						* Without Fan

TL-7077



Wall-mounted Cabinet

- * Material: Cold Rolled Steel
- * Toughened Glass For Front Door
- * Maximum Static Carrying capacity: 30kg
- * Standard Attached Accessories: With Screw and Nut.
- * With Expansion Screw To Fix The Cabinet On The Wall
- * When Order, Necessary Information Following:
 1. The Capacity (U) Of Cabinet: 4, 6, 9, 12, 15U
 2. The Colour Of Cabinet (If you order RT-2042C, Please Let Us The Colour Of The Front Door: Dark Grey Colour Or The Same Colour As Cabinet's Body.)
- * Other Optional Accessories:
 1. 19 Inch Power Panel (Refer To: RT-2081, VT-2087)
 2. Fixed Shelf (RT-2077A)

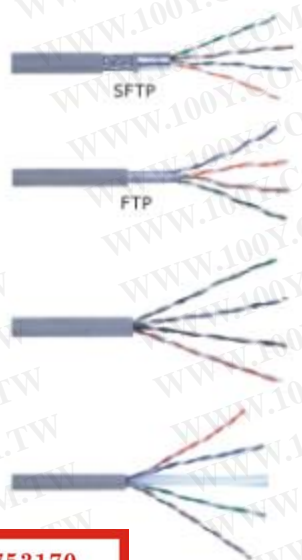

Lan Cable

Item No.	Description
TL-7079A(Solid)	Cat.5E UTP Solid Cable
TL-7079A(Stranded)	Cat.5E UTP Stranded Cable
TL-7079B(Solid)	Cat.6 UTP Solid Cable
TL-7079C(Solid)	Cat.6E FTP Solid Cable
TL-7079D(Solid)	Cat.6E SFTP Solid Cable

- * Comply With ISO/IEC 11801 & ANSI/TIA/EIA-568-B
- * Package:305m/Box

勝特力材料 886-3-5753170
 勝特力电子(上海) 86-21-34970699
 勝特力电子(深圳) 86-755-83298787

[Http://www.100y.com.tw](http://www.100y.com.tw)

ITEM NO	Width	Depth	Capacity (U)	Thickness of steel	Colour	Fan
TL-7078A	600mm	450mm	4U, 6U, 9U, 12U, 15U	Mounting Rail:1.2mm Frame of Front Door:1.2mm Others:1.0mm	*Light Grey *Black	*With 1 Fan
TL-7078B						* Without Fan

TL-7078

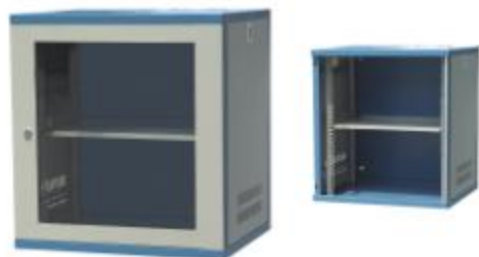

Wall-mounted Cabinet

- * Material: Cold Rolled Steel
- * Toughened Glass For Front Door
- * Maximum Static Carrying capacity: 30kg
- * Standard Attached Accessories: With Screw and Nut.
- * With Expansion Screw To Fix The Cabinet On The Wall
- * When Order, Necessary Information Following:
 1. The Capacity (U) Of Cabinet: 4, 6, 9, 12, 15U
 2. The Colour Of Cabinet (If you order RT-2042C, Please Let Us The Colour Of The Front Door: Dark Grey Colour Or The Same Colour As Cabinet's Body.)
- * Other Optional Accessories:
 1. 19 Inch Power Panel (Refer To: RT-2081, VT-2087)
 2. Fixed Shelf (RT-2077A)



Lan Patch Cord

Item No.	Description
TL-7080A	Cat.5E UTP Patch Cord
TL-7080B	Cat.6 UTP Patch Cord
TL-7080C	Cat.6E SFP Patch Cord

- * Colour Of Cable: Grey, Blue, Red, Yellow, Green...
- * Length Of Cable: 0.5M, 1M, 3M, 5M...

TL-8001



ST Fiber Optic Adaptor

Item No.	Description
TL-8001A	ST SM Simplex Adaptor
TL-8001B	ST MM Simplex Adaptor

SM: Single-Mode
MM: Multi-Mode

TL-8002



Plastic Housing For Adaptor

Item No.	Description
TL-8002A	Plastic Housing For SC Adaptor
TL-8002B	Plastic Housing For ST Adaptor

* Use Plastic Housing To Fix SC/ST Adaptor On The Faceplate (F1-2002/F1-2078/F1-2079)

TL-8003



FC Fiber Optic Adaptor

Item No.	Description
TL-8003A	Square Type (With Screw)
TL-8003B	Square Type (Hole Shape)
TL-8003C	"D" Type

TL-8004

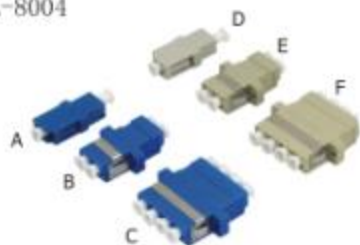

LC Fiber Optic Adaptor

Item No.	Description
TL-8004A	LC SM Simplex Adaptor
TL-8004B	LC SM Duplex Adaptor
TL-8004C	LC SM Fourfold Adaptor
TL-8004D	LC MM Simplex Adaptor
TL-8004E	LC MM Duplex Adaptor
TL-8004F	LC MM Fourfold Adaptor

TL-8005



LC Duplex Fiber Optic Adaptor

Item No.	Description
TL-8005A	LC SM Duplex Adaptor
TL-8005B	LC MM Duplex Adaptor

TL-8006



LC Fiber Optic Adaptor

Item No.	Description
TL-8006A	SC SM Simplex Adaptor
TL-8006B	SC SM Duplex Adaptor
TL-8006C	SC MM Simplex Adaptor
TL-8006D	SC MM Duplex Adaptor

TL-8007



Fiber Optic Connector

Item No.	Description
TL-8007A	ST Connector
TL-8007B	FC Connector
TL-8007C	ST Connector
TL-8007D	LC Connector
TL-8007E	MTRJ - Male Connector
TL-8007F	MTRJ - Female Connector

Order Information:
Please Mark Single-Mode or Multi-Mode For Above Connector
Please Mark Fiber Connector Suitable For The F/D
Cable: 0.5mm, 2.0mm, or 3.0mm

TL-8008



Fiber Optic Adaptor

Item No.	Description
TL-8008A	ST to FC Adaptor
TL-8008B	SC to FC Adaptor

Fiber Optic Accessories

TL-8009



Fiber Type:

- 1: 9/125um Fiber (Single-mode)
- 2: 50/125um Fiber (Multi-mode)
- 3: 62.5/125um Fiber (OM3-mode)

Cable Type:

- A: 3.0m Cable
- B: 2.0m Cable
- C: 0.9m Cable

Pigtails Fiber Optic Patch Cord

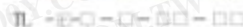

Cable Length:
0L.....1M
0L.....2M
10.....10M

Connector Type:
ST.....ST Type
FC.....FC Type
SC.....SC Type
LC.....LC Type

TL-8010



Fiber Type:

- 1: 9/125um Fiber (Single-mode)
- 2: 50/125um Fiber (Multi-mode)
- 3: 62.5/125um Fiber (OM3-mode)

Cable Type:

- 1: Duplex 3.0m Cable
- 2: Duplex 2.0m Cable

Duplex Fiber Optic Patch Cord



Cable Length:
0L.....1M
0L.....2M
10.....10M

Connector Type (For Both End):
ST.....ST Type
FC.....FC Type
SC.....SC Type
LC.....LC Type
MTR.....MTR Female Type
MTR.....MTR Male Type
MPV/MRJ Connector in 2 Core type

TL-8011



Fiber Type:

- 1: 9/125um Fiber (Single-mode)
- 2: 50/125um Fiber (Multi-mode)
- 3: 62.5/125um Fiber (OM3-mode)

Cable Type:

- A: Simplex 3.0m Jacket Cable
- B: Simplex 2.0m Jacket Cable

Simplex Fiber Optic Patch Cord



Cable Length:
0L.....1M
0L.....2M
10.....10M

Connector Type (For Both End):
ST.....ST Type
FC.....FC Type
SC.....SC Type
LC.....LC Type
MTR.....MTR Type
12000.....12000 APC Type

For Example: TL-5-1-A-ST-SC-02:3.0m Single-Mode ST-SC Simplex F/O Patch Cord 2M

Fiber Optic Accessories

TL-8012



Fiber Optic Splice Case

Item No.	Cable Capacity (Port)	Splice Capacity (Core)
TL-8012	2P Entry, 2P Exit	12, 24, 36, 48 Core

- The Core Capacity Of Each Splice tray is 12Cores
- When Order, Please Mark The Capacity Of F/O Case:
- 12, 24, 36, 48Cores
- Plastic Material: PC
- Environment Temperature: -40°C ~ +65°C
- Mechanical Performance Comply With IEC10113-1 Standards
- The splice Case and Sealing Packing Can be Opened and Refused More than 100 times
- Using Life: 30years

TL-8013



Fiber Optic Splice Closure

Item No.	Cable Capacity (Port)	Splice Capacity (Core)
TL-8013A	2P Entry, 2P Exit	12, 24, 48 Core
TL-8013B	2P Entry, 2P Exit	12, 24, 48 Core

- The Core Capacity Of Each Splice tray is 12Cores
- When Order, Please Mark The Capacity Of F/O Case:
- 12, 24, 36, 48Cores
- Plastic Material: PC
- Environment Temperature: -40°C ~ +65°C
- Mechanical Performance Comply With IEC10113-1 Standards
- The splice Case and Sealing Packing Can be Opened and Refused More than 100 times
- Using Life: 30years

TL-8014



Fiber Optic Splice Closure (Middle Size)

Item No.	Description
TL-8014	F/O Splice Closure (Middle Size)

- The Core Capacity Of Each Splicing Tray Is 24 Cores
- Max Capacity Of Closure: 7pcs Splicing Tray (7x24Cores)
- When You Order, Be Sure To Indicate How Many Pieces Of The Splicing Tray (4-7pcs) are Installed In Closure!

TL-8015



Fiber Optic Splice Closure (Large Size)

Item No.	Description
TL-8015	F/O Splice Closure (Large Size)

- The Core Capacity Of Each Splicing Tray Is 24 Cores
- Max Capacity Of Closure: 12pcs Splicing Tray (12x24Cores)
- When You Order, Be Sure To Indicate How Many Pieces Of The Splicing Tray (6-12pcs) are Installed In Closure!

TL-8016



Fiber Optic Splice Closure (Small Size)

Item No.	Description
TL-8016	F/O Splice Closure (Small Size)

The Core Capacity Of Each Splicing Tray Is 24 Cores
 Max Capacity Of Closure: 7pcs Splicing Tray (7x24Cores)
 When You Order, Be Sure To Indicate How Many Pieces Of The Splicing Tray (2-7pcs) Are Installed In Closure!

TL-8017

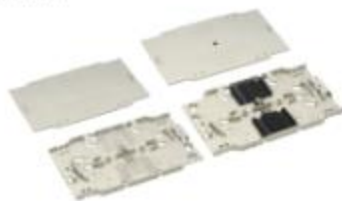

24Cores F/O Patch Panel

Item No.	Description
TL-8017A	12C Splicing Tray
TL-8017B	24C Splicing Tray

* WT-3042 is especially suitable for WT-3030, 3031, 3036

TL-8018



24Cores F/O Patch Panel

Item No.	Description
TL-8018A	With Panel for 24pcs ST Aaptor
TL-8018B	With Panel for 24pcs FC Aaptor
TL-8018C	With Panel for 24pcs SC Aaptor
TL-8018D	With Panel For 12Pcs Duplex SC Adaptor

* Colour: Black or Light Grey (Please Mark the Colour when Order)
 * The Body of panel is easy to be pulled and pushed.
 * Patch Panel with 2Pcs of Splicing Tray (WT-3042A)

TL-8019



24Cores F/O Patch Panel

Item No.	Description
TL-8019A	With Panel for 24pcs ST Aaptor
TL-8019B	With Panel for 24pcs FC Aaptor
TL-8019C	With Panel For 24pcs SC Aaptor

* Colour: Black or Light Grey
 * The Body of panel is easy to be pulled and pushed.
 * When your order, please inform:
 * The panel with or without adaptor to be fitted on panel!

TL-8020



24CORE F/O PATCH PANEL FOR SC DUPLEX-ADAPTOR

Item No.	Description
TL-8020A	With 12Pcs SC Duplex-adapter (Multi-Mode)
TL-8020B	With 12Pcs SC Duplex-adapter (Single-Mode)
TL-8020C	Without SC Duplex-adapter

* Colour: black
 * The body of panel is easy to be pulled and pushed

TL-8021



24Cores F/O Patch Panel

Item No.	Description
TL-8021A	With Panel for 24pcs ST Aaptor
TL-8021B	With Panel for 24pcs FC Aaptor
TL-8021C	With Panel for 24pcs SC Aaptor
TL-8021D	With Panel For 12Pcs Duplex SC Adaptor

* Colour: Black or Light Grey (Please Mark the Colour when Order)
 * The Body of panel is easy to be pulled and pushed
 * Patch Panel with 2Pcs of Splicing Tray (WT-3042)

TL-8022



24Cores F/O Patch Panel

Item No.	Description
TL-8022A	With Panel for 24pcs ST Aaptor
TL-8022B	With Panel for 24pcs FC Aaptor
TL-8022C	With Panel for 24pcs SC Aaptor
TL-8022D	With Panel For 12Pcs Duplex SC Adaptor

* Colour: Black or Light Grey (Please Mark the Colour when Order)
 * The Body of panel is easy to be pulled and pushed
 * Patch Panel with 2Pcs of Splicing Tray (WT-3042A)

TL-8023



12C (24C) Fiber Optic Box (Wall-Mount Type)

Item No.	Description
TL-8023A	12C (With Panel For 12Pcs ST Aaptor)
TL-8023B	12C (With Panel For 12Pcs FC(SC) Aaptor)
TL-8023C	12C (With Panel For 12Pcs SC Duplex Adaptor)
TL-8023D	24C (With Panel For 24Pcs ST Aaptor)
TL-8023E	24C (With Panel For 24Pcs FC(SC) Aaptor)
TL-8023F	24C (With Panel For 12Pcs SC Duplex Adaptor)

* Colour: Black or Light Grey (Please Mark the Colour when Order)
 * The panel For FC To The Same As The Panel For SC

TL-8024



24 Cores F/O Patch Panel

Item No.	Description
TL-8024A	With Panel for 24pcs ST Adaptor
TL-8024B	With Panel for 24pcs FC Adaptor
TL-8024C	With Panel for 24pcs SC Adaptor

- Colour: Black or Light Grey
- The Body of panel is easy to be pulled and pushed
- When your order, please inform:
- The panel with or without adaptor to be fixed on panel?

TL-8028

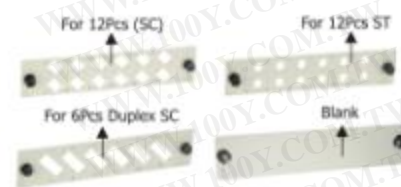

Panel Of Adaptor (For WT-3040)

Item No.	Description
TL-8028A	Panel For 12Pcs ST Adaptor
TL-8028B	Panel For 12Pcs FC Or SC Adaptor
TL-8028C	Panel For 6Pcs SC Duplex Adaptor
TL-8028D	Panel For 12Pcs ST Adaptor

- The Panel Is Specially Suitable For WT-3040
- When Order, Please Mark Colour: Black Or Light Grey
- The panel For FC Is The Same As The Panel For SC.

TL-8025



12 Core F/O Patch Panel

Item No.	Description
TL-8025A	With Panel For 12Pcs ST Adaptor
TL-8025B	With Panel For 12Pcs FC(SC) Adaptor
TL-8025C	With Panel For 6Pcs SC Duplex Adaptor

- The 19 Inch panel is suitable to be fixed on the cabinet.
- The panel for FC Is The Same As The Panel For SC.
- The Panel With 1Pcs Of 12C Splicing Tray
- The Colour Of Panel Is Black Or Light Grey, Please Mark
- The Colour When You Order This Item.

TL-8029



12C(24C) Fiber Optic Box (Wall-Mount Type)

Item No.	Description
TL-8029A	12C With Panel For 12Pcs ST Adaptor
TL-8029B	12C With Panel For 12Pcs FC(SC) Adaptor
TL-8029C	12C With Panel For 6Pcs SC Duplex Adaptor
TL-8029D	24C With Panel For 24Pcs ST Adaptor
TL-8029E	24C With Panel For 24Pcs FC(SC) Adaptor
TL-8029F	24C With Panel For 12Pcs SC Duplex Adaptor

- Colour: Black or Light Grey (Please Mark the Colour when Order)
- The panel for FC Is The Same As The Panel For SC.

TL-8026



24 Core F/O Patch Panel

Item No.	Description
TL-8026A	With Panel For 24Pcs ST Adaptor
TL-8026B	With Panel For 24Pcs FC(SC) Adaptor
TL-8026C	With Panel For 12Pcs SC Duplex Adaptor

- The 19 Inch panel is suitable to be fixed on the cabinet.
- The panel for FC Is The Same As The Panel For SC.
- The Panel With 1Pcs Of 12C Splicing Tray
- The Colour Of Panel Is Black Or Light Grey, Please Mark
- The Colour When You Order This Item.

TL-8030



24 Cores F/O Patch Panel

Item No.	Description
TL-8030A	With Panel for 24pcs ST Adaptor
TL-8030B	With Panel for 24pcs FC Adaptor
TL-8030C	With Panel for 24pcs SC Adaptor
TL-8030D	With Panel For 12Pcs Duplex SC Adaptor

- Colour: Black or Light Grey (Please Mark the Colour when Order)
- The Body of panel is easy to be pulled and pushed
- Patch Panel with 1Pcs of Splicing Tray (WT-3042)

TL-8027



48 Core F/O Patch Panel

Item No.	Description
TL-8027A	With Panel For 48Pcs ST Adaptor
TL-8027B	With Panel For 48Pcs FC(SC) Adaptor
TL-8027C	With Panel For 24Pcs SC Duplex Adaptor

- The 19 Inch panel is suitable to be fixed on the cabinet.
- The panel for FC Is The Same As The Panel For SC.
- The Panel With 1Pcs Of 12C Splicing Tray
- The Colour Of Panel Is Black Or Light Grey, Please Mark
- The Colour When You Order This Item.

TL-8031



24 Cores F/O Patch Panel

Item No.	Description
TL-8031A	With Panel for 24pcs ST Adaptor
TL-8031B	With Panel for 24pcs FC Adaptor
TL-8031C	With Panel for 24pcs SC Adaptor

- Colour: Black or Light Grey
- The Body of panel is easy to be pulled and pushed
- When your order, please inform:
- The panel with or without adaptor to be fixed on panel?

Telephone Accessories

TL-9001



Surface Jack

Item No.	Description
TL-9001A	6P4C
TL-9001B	6P6C
TL-9001C	8P8C

* Size: 56 x 50 x 21mm
* Colour: Ivory or White

TL-9002



3Way Jack

Item No.	Description
TL-9002	6P4C

* Colours: Ivory or White

TL-9003



Duplex Jack

Item No.	Description
TL-9003A	A:6P4C
TL-9003B	B:6P6C
TL-9003C	C:8P8C

* Colour: Ivory or White

TL-9004



Triplex adaptor

Item No.	Description
TL-9004A	A:6P4C
TL-9004B	B:6P6C
TL-9004C	C:8P8C

* Colour: Ivory or White

TL-9005



Cord Coupler

Item No.	Description
TL-9005A	A:6P4C
TL-9005B	B:6P6C
TL-9005C	C:8P8C

* Colour: Ivory or White

TL-9006



Insert Cap

Item No.	Description
TL-9006	Colour: Grey, Blue Yellow, Red, Green, Orange

TL-9007



RJ45 PVC Boot

Item No.	Description
TL-9007	Colour: Grey, Blue, Black, Green, White, Orange

* Φ 5.0mm For Cat. 5E Cable

TL-9008



RJ45 PVC Boot

Item No.	Description
TL-9008	Colour: Grey, Blue, Yellow, Red, Black, Green

* A: Φ 5.0mm For Cat. 5E Cable
* B: Φ 4.0mm For Cat. 6 Cable

Telephone Accessories

Telephone Accessories

TL-9009



8P8C STP Plug

Item No.	Description
TL-9009	With Cable Clip

TL-9013



10P10C Modular Plug

Item No.	Description
TL-9013	10P10C Modular Plug

TL-9010



8P8C STP

Item No.	Description
TL-9010	Cat.6 Plug W/insert

TL-9014



UK Plug

Item No.	Description
TL-9014A	A: 6P6C
TL-9014B	B: 6P6C

TL-9011



8P8C Cat.6 Plug

Item No.	Description
TL-9011	W/insert clamp & boot

TL-9015



RJ45 Plug

Item No.	Description
TL-9015A	Without Shield
TL-9015B	With Shield

When order RT-6002A, Please, Mark The Plug is for solid or stranded cable

TL-9012



8P8C Cat.6 Plug

Item No.	Description
TL-9012	W/insert

TL-9016



Modular Plug

Item No.	Description
TL-9016A	6P2C
TL-9016B	4P4C
TL-9016C	6P4C
TL-9016D	6P6C

TL-9017



Adsl Splitter	
Item No.	Description
TL-9017	2x RJ25 Jack + 1x RJ25 Jack

TL-9018



Adsl Splitter	
Item No.	Description
TL-9018	2x RJ25 Jack + 1x RJ25 Jack

* Colour: Light Grey or Ivory

TL-9019



Adsl Splitter	
Item No.	Description
TL-9019	UK Plug + UK Socket + USA Socket

TL-9020



Adsl Splitter	
Item No.	Description
TL-9020	Adsl Splitter

TL-9021



Single Surface Jack	
Item No.	Description
TL-9021A	6P6C
TL-9021B	6P6C

* Size: 58 x 42 x 24mm
* Colour: Ivory or White

TL-9022



Dual Surface Jack	
Item No.	Description
TL-9022A	6P6C
TL-9022B	6P6C

* Size: 58 x 42 x 24mm
* Colour: Ivory or White

TL-9023



UK Adaptor	
Item No.	Description
TL-9023	UK Plug + UK Socket

TL-9024



UK Adaptor	
Item No.	Description
TL-9024	UK Plug + UK Socket