

# ADAM-6015

# ADAM-6017

# ADAM-6018+

7-ch Isolated RTD Input Modbus TCP Module  
8-ch Isolated Analog Input Modbus TCP Module  
with 2-ch DO

8-ch Isolated Thermocouple Input Module



ADAM-6015    



ADAM-6017    



ADAM-6018+    

## Specifications

### Analog Input

- Channels 7 (differential)
- Input Impedance > 10 M $\Omega$
- Input Connections 2 or 3 wire
- Input Type Pt, Balco and Ni RTD
- RTD Types and Temperature Ranges
 

Pt 100	-50°C ~ 150°C	0°C ~ 100°C	0°C ~ 200°C	0°C ~ 400°C
	-200°C ~ 200°C			
Pt 1000	-40°C ~ 160°C			

 Supports both IEC 60751 ITS90 (0.0385 W/W $^{\circ}$ C) and JIS C 1604 (0.0392 W/W $^{\circ}$ C)
- Balco 500 -30°C ~ 120°C
- Ni 518 -80°C ~ 100°C
- 0°C ~ 100°C
- Accuracy  $\pm 0.1\%$  or better
- High speed mode  $\pm 0.5\%$  or better
- Span Drift  $\pm 25$  ppm/ $^{\circ}$ C
- Zero Drift  $\pm 6$   $\mu$ V/ $^{\circ}$ C
- Resolution 16-bit
- Sampling Rate 10 sample/ second (total)  
High speed mode: 1K sample/second (total)  
CMR @ 50/60 HZ 90dB  
NMR @ 50/60 HZ 60dB  
\* high speed mode does not support CMR/NMR
- Wire Burnout Detection

## Ordering Information

- ADAM-6015 7-ch Isolated RTD Input Modbus TCP Module

## Specifications

### Analog Input

- Channels 8 (differential)
- Input Impedance > 10 M $\Omega$  (voltage)  
120  $\Omega$  (current)
- Input Type mV, V, mA
- Input Range  $\pm 150$ mV,  $\pm 500$ mV,  $\pm 1$  V,  $\pm 5$ V,  $\pm 10$ V, 0 ~ 150mV, 0 ~ 500mV, 0 ~ 1V, 0 ~ 5V, 0 ~ 10V, 0 ~ 20mA, 4 ~ 20mA,  $\pm 20$ mA
- Accuracy  $\pm 0.1\%$  (voltage)  
 $\pm 0.2\%$  (current)
- Span Drift  $\pm 25$  ppm/ $^{\circ}$ C
- Zero Drift  $\pm 6$   $\mu$ V/ $^{\circ}$ C
- Resolution 16-bit
- Sampling Rate 10 or 100 sample/ second (total)  
CMR @ 50/60 HZ 90dB  
NMR @ 50/60 HZ 67dB
- Common-Mode Voltage 350V<sub>DC</sub>

### Digital Output

- Channels 2, open collector to 30 V, 100 mA max. load
- Power Dissipation 300 mW for each module
- Output Delay On: 100 $\mu$ s  
Off: 150 $\mu$ s

## Ordering Information

- ADAM-6017 8-ch Isolated AI with 2-ch DO Modbus TCP Module

## Specifications

### Analog Input

- Channels 8 (differential)
- Input Type Thermocouple
- Thermocouple Type and Range:
 

J	0 ~ 760°C	R	500 ~ 1,750°C
K	0 ~ 1,370°C	S	500 ~ 1,750°C
T	-100 ~ 400°C	B	500 ~ 1,800°C
E	0 ~ 1,000°C		
- Accuracy@25°C Type J,K,E,R,S:  $\pm 0.1\%$  FSR Max  
Type B:  $\pm 0.15\%$  FSR Max  
Type T:  $\pm 0.2\%$  FSR Max
- Span Drift  $\pm 25$  ppm/ $^{\circ}$ C
- Zero Drift  $\pm 6$   $\mu$ V/ $^{\circ}$ C
- Resolution 16-bit
- Sampling Rate 10 sample/ second (total)
- Wire Burnout Detection

## Ordering Information

- ADAM-6018+ 8-ch Isolated Thermocouple Input Module

勝特力電材超市-龍山店 886-3-5773766  
勝特力電材超市-光復店 886-3-5729570  
勝特力電子(上海) 86-21-34970699  
勝特力電子(深圳) 86-755-83298787  
<http://www.100y.com.tw>

## Common Specifications

### General

- Certification CE, FCC, UL  
\*Class I, Division 2, Groups A, B, C and D Hazardous Locations for ADAM-6015 and ADAM-6017
- LAN 10/100Base-T(X)
- Power Consumption 2.5 W @ 24 V<sub>DC</sub> (ADAM-6015)  
2.7 W @ 24 V<sub>DC</sub> (ADAM-6017)  
1 W @ 24 V<sub>DC</sub> (ADAM-6018+)
- Connectors 1 x RJ-45 (LAN), Plug-in screw terminal block (I/O and power)

### Watchdog

System (1.6 second) and Communication (programmable)  
10 ~ 30 V<sub>DC</sub>

### Power Input

- Supports Peer-to-Peer
- Supports GCL
- Supports Modbus/TCP, TCP/IP, UDP, RESTful
- Supports MQTT (D version), SNMP (D version) Protocols (ADAM-6017 and ADAM-6018+)

### Protection

- Isolation Protection 2,000 V<sub>DC</sub>
- Built-in TVS/ESD Protection
- Power Reversal Protection

### Environment

- Operating Temperature -10 ~ 70°C (14 ~ 158°F)  
-40 ~ 70°C (-40~158°F) (D version)
- Storage Temperature -20 ~ 80°C (-4 ~ 176°F)  
-40 ~ 85°C (-40~185°F) (D version)
- Operating Humidity 20 ~ 95% RH (non-condensing)
- Storage Humidity 0 ~ 95% RH (non-condensing)

# ADAM-6022

# ADAM-6024

## Ethernet-based Dual-loop PID Controller

## 12-ch Isolated Universal Input/Output Modbus TCP Module

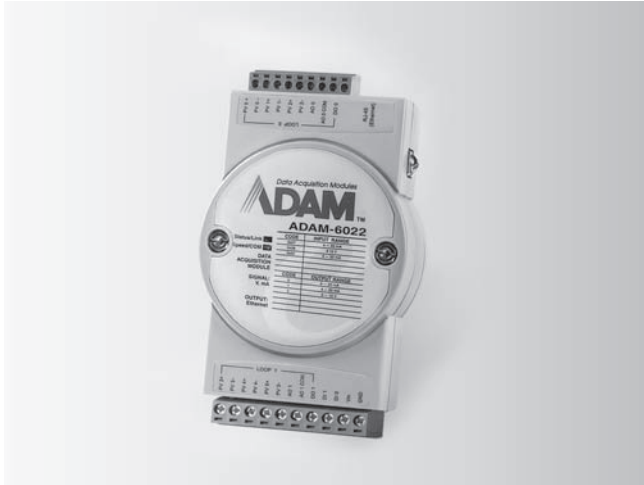

ADAM-6022



### Specifications

#### General

- **Loop Number** 2 (3 AI, 1 AO, 1 DI, 1 DO for each control loop)

#### Analog Input

- **Channels** 6 (differential)
- **Input Range**  $\pm 10 V_{DC}$ , 0 ~ 20 mA, 4 ~ 20 mA

#### Analog Output

- **Channels** 2
- **Output Type** V, mA
- **Output Range** 0 ~ 10  $V_{DC}$ , 4 ~ 20 mA, 0 ~ 20 mA

#### Digital Input

- **Channels** 2
- **Dry Contact** Logic level 0: close to GND  
Logic level 1: open
- **Wet Contact** Logic level 0: 0 ~ 3  $V_{DC}$   
Logic level 1: 10 ~ 30  $V_{DC}$

#### Digital Output

- **Channels** 2, open collector to 30 V, 100 mA max. load
- **Power Dissipation** 300 mW for each module

### Ordering Information

- **ADAM-6022** Ethernet-based Dual-loop PID Controller



ADAM-6024



### Specifications

#### Analog Input

- **Channels** 6 (differential)
- **Input Range**  $\pm 10 V_{DC}$ , 0 ~ 20 mA, 4 ~ 20 mA

#### Analog Output

- **Channels** 2
- **Output Type** V, mA
- **Output Range** 0 ~ 10  $V_{DC}$ , 4 ~ 20 mA, 0 ~ 20 mA

#### Digital Input

- **Channels** 2
- **Dry Contact** Logic level 0: close to GND  
Logic level 1: open
- **Wet Contact** Logic level 0: 0 ~ 3  $V_{DC}$   
Logic level 1: 10 ~ 30  $V_{DC}$

#### Digital Output

- **Channels** 2, open collector to 30 V, 100 mA max. load
- **Power Dissipation** 300 mW for each module

#### Supports

- **Peer-to-Peer (Receiver only)**
- **GCL (Receiver only)**

### Ordering Information

- **ADAM-6024** 12-ch Isolated Universal I/O Modbus TCP Module

### Common Specifications

#### General

- **Certification** CE, FCC, UL
- **LAN** 10/100Base-T(X)
- **Power Consumption** 4 W @ 24  $V_{DC}$
- **Connectors** 1 x RJ-45 (LAN), Plug-in screw terminal block (I/O and power)
- **Watchdog** System (1.6 second) and Communication (programmable)
- **Power Input** 10 ~ 30  $V_{DC}$
- **Supports Modbus/TCP, TCP/IP, UDP, RESTful (D version), MQTT (D version), SNMP (D version)**

#### Analog Input

- **Input Impedance** 20 M $\Omega$
- **Accuracy**  $\pm 0.1\%$  of FSR
- **Resolution** 16-bit
- **Sampling Rate** 10 sample/second
- **CMR @ 50/60 Hz** 90 dB
- **NMR @ 50/60 Hz** 60 dB
- **Span Drift**  $\pm 25$  ppm/ $^{\circ}$  C
- **Zero Drift**  $\pm 6$   $\mu$ V/ $^{\circ}$  C

#### Analog Output

- **Accuracy**  $\pm 0.1\%$  of FSR
- **Resolution** 12-bit
- **Drift**  $\pm 50$  ppm/ $^{\circ}$  C
- **Current Load Resistor** Max. 500 $\Omega$
- **Voltage Load Resistor** Min. 1K  $\Omega$

#### Protection

- **Isolation Protection** 2,000  $V_{DC}$
- **Built-in TVS/ESD Protection**
- **DI Over Voltage Protection** 35  $V_{DC}$
- **Power Reversal Protection**

#### Environment

- **Operating Temperature** -10 ~ 50 $^{\circ}$  C (14 ~ 122 $^{\circ}$  F)  
D version: -40 ~ 70 $^{\circ}$  C (-40~158 $^{\circ}$  F)
- **Storage Temperature** -20 ~ 80 $^{\circ}$  C (-4 ~ 176 $^{\circ}$  F)  
D version: -40 ~ 80 $^{\circ}$  C (-40~176 $^{\circ}$  F)
- **Operating Humidity** 20 ~ 95% RH (non-condensing)
- **Storage Humidity** 0 ~ 95% RH (non-condensing)

# ADAM-6050

# ADAM-6051

# ADAM-6052

**18-ch Isolated Digital I/O Modbus TCP Module**

**14-ch Isolated Digital I/O Modbus TCP Module with 2-ch Counter**

**16-ch Source-type Isolated Digital I/O Modbus TCP Module**



ADAM-6050



ADAM-6051

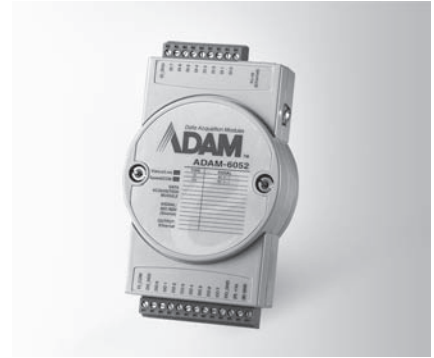

ADAM-6052



## Specifications

### Digital Input

- **Channels** 12
- **Dry Contact** Logic level 0: Closed to GND  
Logic level 1: Open
- **Wet Contact** Logic level 0: 0 ~ 3 V<sub>DC</sub>  
Logic level 1: 10 ~ 30 V<sub>DC</sub> or floating  
Support DO type: Sink (NPN)
- **Supports 3 kHz Counter Input (32-bit + 1-bit overflow)**
- **Keep/Discard Counter Value when Power-off**
- **Supports 3 kHz Frequency Input**

### Digital Output

- **Channels** 6 (sink type), open collector to 30 V, 100 mA maximum load
- **Supports 5 kHz Pulse Output**
- **Supports High-to-Low and Low-to-High Delay Output**

### Ordering Information

- **ADAM-6050-D1** 18-ch Isolated DI/O Modbus TCP Module

## Specifications

### Digital Input

- **Channels** 12
- **Dry Contact** Logic level 0: Closed to GND  
Logic level 1: Open
- **Wet Contact** Logic level 0: 0 ~ 3 V<sub>DC</sub>  
Logic level 1: 10 ~ 30 V<sub>DC</sub> or floating  
Support DO type: Sink (NPN)
- **Supports 3 kHz Counter Input (32-bit + 1-bit overflow)**
- **Keep/Discard Counter Value when Power-off**
- **Supports 3 kHz Frequency Input**

### Counter Input

- **Channels** 2
- **Mode** Counter, Frequency
- **Keep/Discard Counter Value when Power-off**
- **Maximum Count** 4,294,967,295 (32-bit + 1-bit overflow)
- **Input Frequency** Frequency Mode: 0.2 ~ 4500 Hz  
Counter Mode: 0 ~ 4.5 kHz

### Digital Output

- **Channels** 2 (sink type), open collector to 30 V, 100 mA maximum load
- **Supports 5 kHz Pulse Output**
- **Supports High-to-Low and Low-to-High Delay Output**

## Ordering Information

- **ADAM-6051-D** 16-ch Isolated DI/O with Counter Modbus TCP Module

## Specifications

### Digital Input

- **Channels** 8  
Dry/Wet Contact decided by switch or jumper
- **Dry Contact** Logic level 0: Open  
Logic level 1: Closed to GND
- **Wet Contact** Logic level 0: 0 ~ 3 V<sub>DC</sub> or floating  
Logic level 1: 10 ~ 30 V<sub>DC</sub>  
Support DO type: Source (PNP)
- **Supports 3 kHz Counter Input (32-bit + 1-bit overflow)**
- **Keep/Discard Counter Value when Power-off**
- **Supports 3 kHz Frequency Input**

### Digital Output

- **Channels** 8 (Source Type)
- **Voltage Range** 10 ~ 35 V<sub>DC</sub>
- **Current** 1 A (per channel)
- **Supports 5 kHz Pulse Output**
- **Supports High-to-Low and Low-to-High Delay Output**
- **Supports Over Current Protection**

## Ordering Information

- **ADAM-6052-D** 16-ch Source-type Isolated DI/O Modbus TCP Module

## Common Specifications

### General

- **Certification** FCC, CE, UL  
\*Class I, Division 2, Groups A, B, C and D Hazardous Locations
- **LAN** 1-port 10/100Base-T(X)
- **Power Consumption** 2 W @ 24 V<sub>DC</sub>
- **Connectors** 1 x RJ-45 (LAN), Plug-in screw terminal block (I/O and power)
- **Watchdog** System (1.6 second) and Communication (programmable)

- **Power Input** 10 ~ 30 V<sub>DC</sub>
- **Supports Peer-to-Peer, GCL**
- **Supports User Defined Modbus Address**
- **Supports Modbus/TCP, TCP/IP, UDP, RESTful, MQTT (D version), SNMP (D version) Protocol**

### Protection

- **Power Reversal Protection**
- **Isolation Protection** 2,000 V<sub>DC</sub>

### Environment

- **Operating Temperature** -20 ~ 70°C (-4 ~ 158°F)  
D version -40 ~ 70°C (-40 ~ 158°F)
- **Storage Temperature** -30 ~ 80°C (-22 ~ 176°F)  
D version -40 ~ 85°C (-40 ~ 185°F)
- **Operating Humidity** 20 ~ 95% RH (non-condensing)
- **Storage Humidity** 0 ~ 95% RH (non-condensing)

# ADAM-6060

# ADAM-6066

6-ch Digital Input and 6-ch Relay  
Modbus TCP Module

6-ch Digital Input and 6-ch Power Relay  
Modbus TCP Module



ADAM-6060

ADAM-6066



## Specifications

### General

- LAN 1-port 10/100Base-T(X)
- Power Consumption 2 W @ 24 V<sub>DC</sub> (ADAM-6060)  
2.5 W @ 24 V<sub>DC</sub> (ADAM-6066)
- Connectors 1 x RJ-45 (LAN), Plug-in screw terminal block (I/O and power)
- Watchdog Timer System (1.6 second) and Communication (programmable)
- Power Input 10 ~ 30 V<sub>DC</sub>
- Supports Peer-to-Peer
- Supports GCL
- Supports Modbus/TCP, TCP/IP, UDP, DHCP, SNMP, RESTful and MQTT Protocol

### Digital Input

- Channels 6
- Dry Contact Logic level 0: Closed to GND  
Logic level 1: Open
- Wet Contact Logic level 0: 3 V<sub>DC</sub>  
Logic level 1: 10 ~ 30 V<sub>DC</sub> or floating  
Support DO type: Sink (NPN) only
- Supports 3 kHz Counter Input (32-bit + 1-bit overflow)
- Keep/Discard Counter Value when Power-off
- Supports 3 kHz Frequency Input
- Supports Inverted DI Status

### Relay Output (Form A)

- Channels 6
- Contact Rating (Resistive) ADAM-6060: 120 V<sub>AC</sub> @ 0.5 A  
30 V<sub>DC</sub> @ 1 A  
ADAM-6066: 250 V<sub>AC</sub> @ 5 A  
30 V<sub>DC</sub> @ 3 A
- Breakdown Voltage 500 V<sub>AC</sub> (50/60 Hz)
- Relay On Time 7 ms
- Relay Off Time 3 ms
- Total Switching Time 10 ms
- Insulation Resistance 1 GΩ min. at 500 V<sub>DC</sub>
- Maximum Switching Rate (at rated load) 20 operations/minute
- Supports Pulse Output

### Protection

- Isolation Voltage 2,000 V<sub>DC</sub>
- Power Reversal Protection

### Environment

- Operating Temperature -40 ~ 70°C (-40~158°F)
- Storage Temperature -40 ~ 80°C (-40~176°F)
- Operating Humidity 20 ~ 95% RH (non-condensing)
- Storage Humidity 0 ~ 95% RH (non-condensing)

## Ordering Information

- ADAM-6060-D1 6-ch DI and 6-ch Relay Modbus TCP Module
- ADAM-6066-D 6-ch DI and 6-ch Power Relay Modbus TCP Module

## ADAM-6000 Series Dimensions

Unit: mm

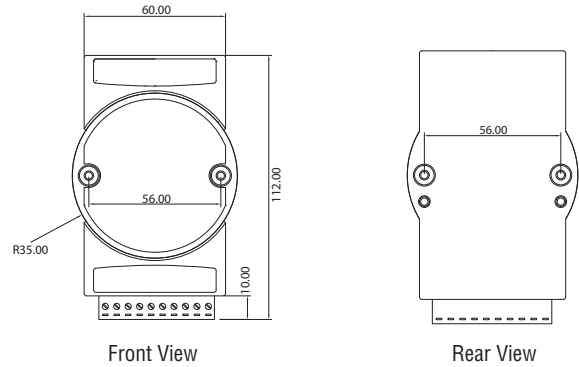

Front View

Rear View

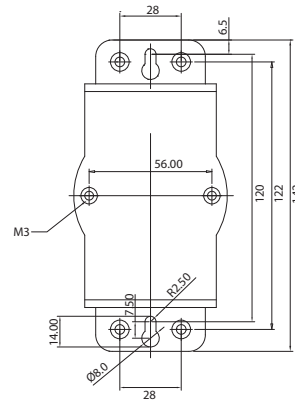

Wall Mounting View

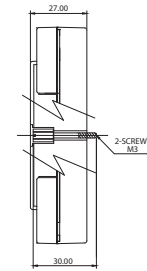

Side View

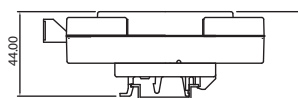

DIN-Rail Mounting View

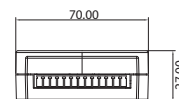

Top View

## ADAM-6000 Series Common Specifications

### General

- Dimensions (W x H x D) 70 x 120 x 30 mm
- Enclosure ABS+PC
- Mounting DIN 35 rail, stack, wall

# ADAM-6217

# ADAM-6224

## 8-ch Isolated Analog Input Modbus TCP Module

## 4-ch Isolated Analog Output Modbus TCP Module



ADAM-6217



ADAM-6224



### Specifications

#### Analog Input

- **Channels** 8 (differential)
- **Input Impedance** > 10 MW (voltage)  
120 W (current)
- **Input Type** mV, V, mA
- **Input Range**  $\pm 150$  mV,  $\pm 500$  mV,  $\pm 1$  V,  $\pm 5$  V,  $\pm 10$  V, 0 ~ 20 mA, 4 ~ 20 mA,  $\pm 20$  mA
- **Span Drift**  $\pm 30$  ppm/ $^{\circ}$ C
- **Zero Drift**  $\pm 6$   $\mu$ V/ $^{\circ}$ C
- **Resolution** 16-bit
- **Accuracy**  $\pm 0.1\%$  of FSR (Voltage) at 25 $^{\circ}$ C  
 $\pm 0.2\%$  of FSR (Current) at 25 $^{\circ}$ C
- **Sampling Rate** 10 sample/second (total)
- **CMR @ 50/60 Hz** 92 dB
- **NMR @ 50/60 Hz** 67 dB
- **Common Mode** 200 V<sub>DC</sub>

### Ordering Information

- **ADAM-6217** 8-ch Isolated Analog Input Modbus TCP Module

### Specifications

#### Analog Output

- **Channels** 4
- **Output Impedance** 2.1  $\Omega$
- **Output Settling Time** 20  $\mu$ s
- **Driving Load** Voltage: 2k $\Omega$   
Current: 500  $\Omega$
- **Programmable Output Slope** 0.125 ~ 128 mA/sec
- **Output Type** 0.0625 ~ 64 V/sec
- **Output Range** V, mA
- **Accuracy** 0 ~ 5 V, 0 ~ 10 V,  $\pm 5$  V,  $\pm 10$  V, 0 ~ 20 mA, 4 ~ 20 mA  
 $\pm 0.3\%$  of FSR (Voltage) at 25 $^{\circ}$ C  
 $\pm 0.5\%$  of FSR (Current) at 25 $^{\circ}$ C
- **Resolution** 12-bit
- **Current Load Resistor** 0 ~ 500  $\Omega$
- **Drift**  $\pm 50$  ppm/ $^{\circ}$ C

#### Digital Input

- **Channels** 4 (Dry Contact only)
- **Dry Contact** Logic 0: Open  
Logic 1: Closed to DGND

- **Support DI Filter**
- **Support Inverted DI Status**
- **Support Trigger to Startup or Safety Value**

### Ordering Information

- **ADAM-6224** 4-ch Isolated Analog Output Modbus TCP Module

### Common Specifications

#### General

- **Ethernet** 2-port 10/100 Base-TX (for Daisy Chain)
- **Protocol** Modbus TCP, TCP/IP, UDP, HTTP, DHCP, RESTful, SNMP (B version), MQTT (B version)
- **Connector** Plug-in 5P/15P screw terminal blocks
- **Power Input** 10 ~ 30 V<sub>DC</sub> (24 V<sub>DC</sub> standard)
- **Watchdog Timer** System (1.6 seconds)  
Communication (Programmable)
- **Dimensions** 70 x 122 x 27 mm
- **Protection** Built-in TVS/ESD protection  
Power Reversal protection  
Isolation protection: 2500 V<sub>DC</sub>
- **Power Consumption** ADAM-6217: 3.5W @ 24 V<sub>DC</sub>  
ADAM-6224: 6W @ 24 V<sub>DC</sub>

#### Features

- Daisy chain connection with auto-bypass protection
- Remote monitoring and control with smart phone/pad
- Group configuration capability for multiple module setup
- Flexible user-defined Modbus address
- Intelligent control ability by Peer-to-Peer and GCL function
- Multiple protocol support: Modbus TCP, TCP/IP, UDP, HTTP, DHCP, RESTful, SNMP (B version), MQTT (B version)
- Web language support: XML, HTML 5, Java Script
- System configuration backup
- User Access Control

#### Environment

- **Operating Temperature** -10 ~ 70 $^{\circ}$ C (14 ~ 158 $^{\circ}$ F)  
-40 ~ 70 $^{\circ}$ C (-40 ~ 158 $^{\circ}$ F) (B version)
- **Storage Temperature** -20 ~ 80 $^{\circ}$ C (-4 ~ 176 $^{\circ}$ F)  
-40 ~ 85 $^{\circ}$ C (-40 ~ 185 $^{\circ}$ F) (B version)
- **Operating Humidity** 20 ~ 95% RH (non-condensing)
- **Storage Humidity** 0 ~ 95% RH (non-condensing)

# ADAM-6250

# ADAM-6251

# ADAM-6256

**15-ch Isolated Digital I/O Modbus TCP Module**

**16-ch Isolated Digital Input Modbus TCP Module**

**16-ch Isolated Digital Output Modbus TCP Module**

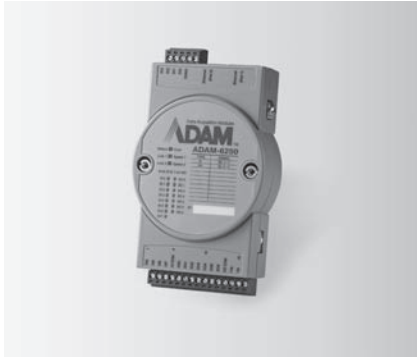

ADAM-6250

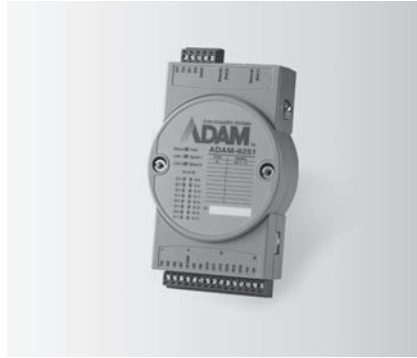

ADAM-6251

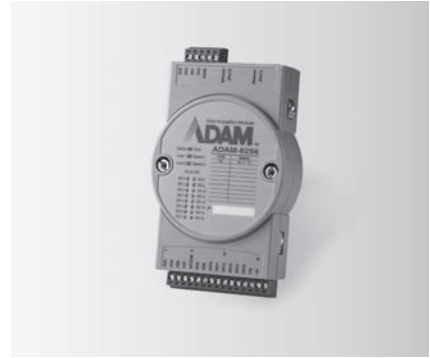

ADAM-6256



## Specifications

### Digital Input

- **Channels** ADAM-6250: 8  
ADAM-6251: 16
- **Dry Contact** Logic 0: Open  
Logic 1: Closed to DGND
- **Wet Contact** Logic 0: 0 ~ 3 V<sub>DC</sub> or 0 ~ -3 V<sub>DC</sub>  
Logic 1: 10 ~ 30 V<sub>DC</sub> or -10 ~ -30 V<sub>DC</sub>  
(Dry/Wet Contact decided by Switch)
- **Input Impedance** 5.2 k $\Omega$  (Wet Contact)
- **Transition Time** 0.2 ms
- **Frequency Input Range** 0.1 ~ 3kHz
- **Counter Input** 3kHz (32 bit + 1 bit overflow)
- **Keep/Discard Counter Value when power off**
- **Supports Inverted DI Status**

### Digital Output

- **Channels** ADAM-6250: 7 (Sink Type)  
ADAM-6256: 16 (Sink Type)
- **Output Voltage Range** 10 ~ 30 V<sub>DC</sub>
- **Normal Output Current** 100 mA (per channel)
- **Pulse Output** Up to 5kHz
- **Delay Output** High-to-Low and Low-to-High

## Ordering Information

- **ADAM-6250** 15-ch Isolated Digital I/O Modbus TCP Module
- **ADAM-6251** 16-ch Isolated Digital Input Modbus TCP Module
- **ADAM-6256** 16-ch Isolated Digital Output Modbus TCP Module

## Common Specifications

### General

- **Certification** CE,FCC,UL
- **Ethernet** 2-port 10/100 Base-TX (for Daisy Chain)
- **LED Indication** ADAM-6250: 8 DI + 7 DO  
ADAM-6251: 16 DI  
ADAM-6256: 16 DO
- **Protocol** Modbus/TCP, TCP/IP, UDP, HTTP, DHCP, MQTT, SNMP
- **Connector** Plug-in 5P/15P screw terminal blocks
- **Power Input** 10 ~ 30 V<sub>DC</sub> (24 V<sub>DC</sub> standard)
- **Watchdog Timer** System (1.6 seconds)  
Communication (Programmable)
- **Dimensions** 70 x 122 x 27 mm
- **Protection** Built-in TVS/ESD protection  
Power Reversal protection  
Over Voltage protection: +/- 35V<sub>DC</sub>  
Isolation protection: 2500 V<sub>DC</sub>
- **Power Consumption** ADAM-6250: 3 W @ 24 V<sub>DC</sub>  
ADAM-6251: 2.7 W @ 24 V<sub>DC</sub>  
ADAM-6256: 3.2 W @ 24 V<sub>DC</sub>

### Features

- Daisy chain connection with auto-bypass protection
- Remote monitoring and control with smart phone/pad
- Group configuration capability for multiple module setup
- DI/O LED Indication
- Flexible user-defined Modbus address.
- Intelligent control ability by Peer-to-Peer and GCL function
- Multiple protocol support: Modbus/TCP, TCP/IP, UDP, HTTP, DHCP, MQTT, SNMP
- Web language support: XML, HTML 5, Java Script
- System configuration backup
- User Access Control

### Environment

- **Operating Temperature** -10 ~ 70°C (14 ~ 158°F)  
-40 ~ 70°C (-40~158°F) (B version)
- **Storage Temperature** -20 ~ 80°C (-4 ~ 176°F)  
-40 ~ 80°C (-40~176°F) (B version)
- **Operating Humidity** 20 ~ 95% RH (non-condensing)
- **Storage Humidity** 0 ~ 95% RH (non-condensing)

# ADAM-6260

# ADAM-6266

## 6-ch Relay Output Modbus TCP Module

## 4-ch Relay Output Modbus TCP Module with 4-ch DI

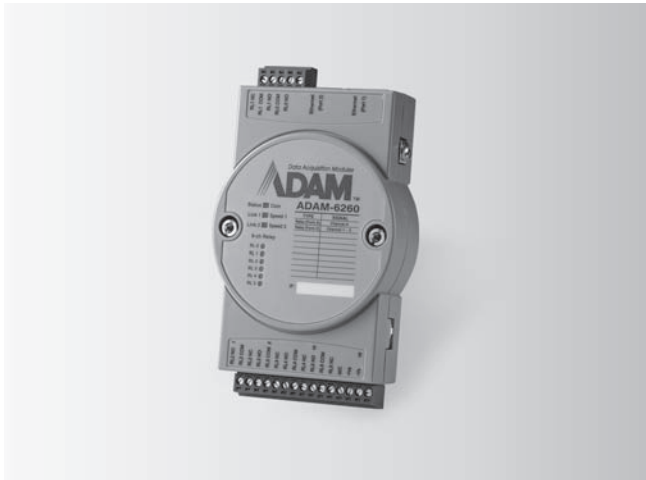

ADAM-6260

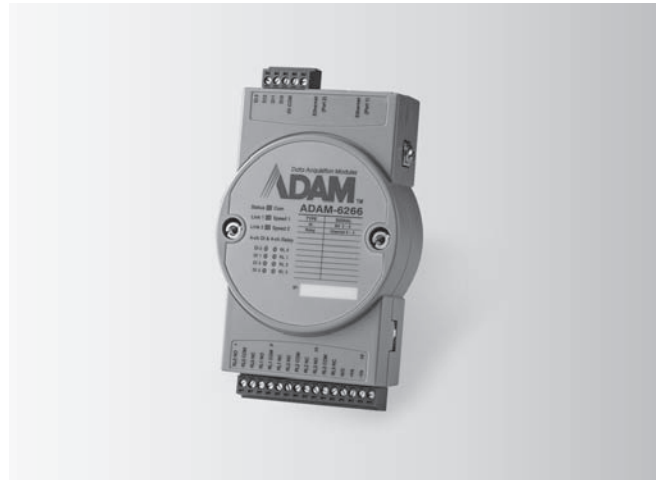

ADAM-6266



## Specifications

### Relay Output

- **Channels** ADAM-6260: 5 Form C and 1 Form A  
ADAM-6266: 4 Form C
- **Contact Rating (Resistive)** 250 V<sub>AC</sub> @ 5A  
30 V<sub>DC</sub> @ 5A
- **Max. Switching Voltage** 400 V<sub>AC</sub>  
300 V<sub>DC</sub>
- **Breakdown Voltage** 500 V<sub>AC</sub> (50/60Hz)
- **Max. Breakdown Capacity** 1250 VA
- **Frequency of Operation** 360 operations/hour with load  
72,000 operations/hour without load
- **Set/Reset Time** 8 ms/8 ms
- **Mechanical Endurance** > 15 x 10<sup>6</sup> operations
- **Isolation between Contact** 1000 V<sub>rms</sub>
- **Insulation Resistance** > 10 GΩ @ 500 V<sub>DC</sub>

### Digital Input

- **Channels** ADAM-6266: 4
- **Dry Contact** Logic 0: Open  
Logic 1: Closed to DI COM
- **Wet Contact** Logic 0: 0 ~ 3 V<sub>DC</sub> or 0 ~ -3 V<sub>DC</sub>  
Logic 1: 10 ~ 30 V<sub>DC</sub> or -10 ~ -30 V<sub>DC</sub>  
(Dry/Wet Contact decided by Switch)
- **Input Impedance** 5.2 kΩ (Wet Contact)
- **Transition Time** 0.2 ms
- **Frequency Input Range** 0.1 ~ 3kHz
- **Counter Input** 3kHz (32 bit + 1 bit overflow)
- **Keep/Discard Counter Value when power off**
- **Supports Inverted DI Status**

## Ordering Information

- **ADAM-6260** 6-ch Relay Output Modbus TCP Module
- **ADAM-6266** 4-ch Relay Output Modbus TCP Module with 4-ch DI

## Common Specifications

### General

- **Ethernet** 2-port 10/100 Base-TX (for Daisy Chain)
- **LED Indication** ADAM-6260: 6 RL  
ADAM-6266: 4 RL + 4 DI
- **Protocol** Modbus/TCP, TCP/IP, UDP, HTTP, DHCP, SNMP, MQTT
- **Connector** Plug-in 5P/15P screw terminal blocks
- **Power Input** 10 - 30 V<sub>DC</sub> (24 V<sub>DC</sub> standard)
- **Watchdog Timer** System (1.6 seconds)  
Communication (Programmable)
- **Dimensions** 70 x 122 x 27 mm
- **Protection** Built-in TVS/ESD protection  
Power Reversal protection  
Over Voltage protection: +/- 35V<sub>DC</sub>  
Isolation protection: 2500 V<sub>DC</sub>
- **Power Consumption** ADAM-6260: 4.5 W @ 24 V<sub>DC</sub>  
ADAM-6266: 4.2 W @ 24 V<sub>DC</sub>

### Features

- Daisy chain connection with auto-bypass protection
- Remote monitoring and control with smart phone/pad
- Group configuration capability for multiple module setup
- DI/O LED Indication
- Flexible user-defined Modbus address.
- Intelligent control ability by Peer-to-Peer and GCL function
- Multiple protocol support: Modbus/TCP, TCP/IP, UDP, HTTP, DHCP, SNMP, MQTT
- Web language support: XML, HTML 5, Java Script
- System configuration backup
- User Access Control

### Environment

- **Operating Temperature** -10 ~ 70°C (14 ~ 158°F)  
-40 ~ 70°C (-40~158°F) (B version)
- **Storage Temperature** -20 ~ 80°C (-4 ~ 176°F)  
-40 ~ 80°C (-40~176°F) (B version)
- **Operating Humidity** 20 ~ 95% RH (non-condensing)
- **Storage Humidity** 0 ~ 95% RH (non-condensing)

# ADAM-6315

# ADAM-6317

IoT OPC UA Ethernet I/O - RTD Module

IoT OPC UA Ethernet I/O - AI Module



ADAM-6315



## Specifications

### Analog Input

- Channels 8 (differential)
  - Input Impedance > 10 M $\Omega$
  - Input Connections 2 or 3 wire
  - Input Type Pt, Balco and Ni RTD
  - RTD Types and Temperature Ranges
    - Pt 100
      - 50°C - 150°C
      - 0°C - 100°C
      - 0°C - 200°C
      - 0°C - 400°C
      - 100°C - 100°C
      - 200°C - 200°C
- \*Supports both IEC 60751 ITS90 (0.00385 $\Omega$ /°C) and JIS C 1604 (0.00392 $\Omega$ /°C)
- Pt 1000
    - 40°C - 160°C
  - Balco 500
    - 30°C - 120°C
  - Ni 508
    - 0°C - 100°C
  - Ni 518
    - 80°C - 100°C
- Accuracy  $\pm 0.1\%$  or better  
High speed mode  $\pm 0.5\%$  or better
  - Span Drift  $\pm 25$  ppm/°C
  - Zero Drift  $\pm 6$   $\mu$ V/°C
  - Resolution 16-bit
  - Sampling Rate Normal speed mode: 10 sample/second (total)  
High speed mode: 1024 sample/second (total)  
CMR: 90 dB @ 50/60 HZ  
NMR: 60 dB @ 50/60 HZ

\* High speed mode does not support CMR/NMR

### Wire Burnout Detection

### Digital Input

- Channels 6
- Dry contact logic 0: Open; logic 1: Closed to ground
- Wet contact logic 0: 0 - 3 V<sub>cc</sub> or floating; logic 1: 10 - 30 V<sub>cc</sub>
- Support DO type: Sink (NPN) and Source (PNP)
- DI0-DI5 support 3 kHz counter input
- DI0-DI5 support 3 kHz frequency input

### Digital Output

- Channels 8
- Output type Sink type, 30 V<sub>cc</sub>, 0.1A max. per channel
- DO2-DO7 support 3 kHz pulse output

## Ordering Information

- ADAM-6315-A1 OPC UA and Security Remote I/O - RTD Module

## Common Specifications

### General

- Power input 10 - 30 V<sub>cc</sub>
- Power Consumption 2.9 W @ 24 V<sub>cc</sub> (ADAM-6317)  
2.8 W @ 24 V<sub>cc</sub> (ADAM-6350)
- LAN port 2-port 10/100 Base-T(X) (for Daisy Chain)
- Connectors 2 x RJ-45 (LAN), Plug-in screw terminal block (I/O and power)
- Watchdog System and Communication
- Protocol OPC UA, Modbus

### Protection

- Isolation 2,500 V<sub>cc</sub>
- Power Reversal Protection



ADAM-6317



## Specifications

### Analog Input

- Channels 8 (differential)
- Sampling Rate 10 or 100 samples/second (total)
- Resolution 16 bits
- Input Range 0 - 150mV, 0 - 500mV,  
0 - 1V, 0 - 5V, 0 - 10V,  
 $\pm 150$  mV,  $\pm 500$  mV,  $\pm 1V$ ,  
 $\pm 5$  V,  $\pm 10$  V,  $\pm 20$  mA,  
0 - 20 mA, 4 - 20mA

### Digital Input

- Channels 11
- Dry contact logic 0: Open
- logic 1: Closed to ground
- logic 0: 0 - 3 V<sub>cc</sub> or floating
- logic 1: 10 - 30 V<sub>cc</sub>
- Support DO type: Sink (NPN) and Source (PNP)
- DI5-DI10 support 3 kHz counter input
- DI5-DI10 support 3 kHz frequency input

### Digital Output

- Channels 10
- Output type Sink type, 30 V<sub>cc</sub>,  
0.1A max. per channel
- DO4-DO9 support 3 kHz pulse output

## Ordering Information

- ADAM-6317-A1 OPC UA and Security Remote I/O - AI Module

### OPC UA

- Max Monitored Items 600 (A maximum of 32 ScaledValueHistory items can be included in all sessions)
- Max Sessions 4 (including security or non-security session)
- Max Subscriptions per Session 1
- Support security/certificate management

### Modbus/TCP

- Modbus/TCP connection 4

### Environment

- Operating Temperature -25°C - 70°C
- Storage Temperature -25°C - 85°C
- Operating Humidity 20 - 95% RH (non-condensing)
- Storage Humidity 0 - 95% RH (non-condensing)

# ADAM-6350

# ADAM-6360D

# ADAM-6366

IoT OPC UA Ethernet I/O - DI/O Module

IoT OPC UA Ethernet I/O - SSR Relay Output Module

IoT OPC UA Ethernet I/O - SSR Relay Output Module



ADAM-6350



ADAM-6360D



ADAM-6366



## Specifications

### Digital Input

- Channels 18
- Dry contact logic 0: Open  
logic 1: Closed to ground
- Wet contact logic 0: 0 ~ 3 V<sub>DC</sub> or floating  
logic 1: 10 ~ 30 V<sub>DC</sub>  
Support DO type:  
Sink (NPN) and Source (PNP)
- DI12~DI17 support 3 kHz counter input
- DI12~DI17 support 3 kHz frequency input

### Digital Output

- Channels 18
- Output type Sink type, 30 V<sub>DC</sub>,  
0.1A max. per channel
- DO12~DO17 support 3 kHz pulse output

## Specifications

### Relay Output (PhotoMOS SPST)

- Channels 8 (Form A)
- Contact rating (Resistive and Inductive load) 1 A @25°C @30 V<sub>DC</sub>  
0.7A @70°C @30 V<sub>DC</sub>
- Relay-on time 1.3 ms
- Relay-off time 0.8 ms
- Isolation (Relay output to power) 1500Vrms
- Peak Load Current 4A (100ms (1 pulse))
- Total Power Dissipation 400mW / channel
- On-state resistance 0.5Ω

### Digital Input

- Channels 14
- Dry contact logic 0: Open  
logic 1: Closed to ground
- Wet contact logic 0: 0 ~ 3 V<sub>DC</sub> or floating  
logic 1: 10 ~ 30 V<sub>DC</sub>  
Support DO type:  
Sink (NPN) and Source (PNP)
- DI8~DI13 support 3 kHz counter input
- DI8~DI13 support 3 kHz frequency input

### Digital Output

- Channels 6
- Output type Sink type, 30 V<sub>DC</sub>,  
0.1A max. per channel
- DO0~DO5 support 3 kHz pulse output

## Specifications

### Relay Output

- Channels 6 (Form A)
- Contact rating 0.25A@250V<sub>AC</sub>  
2A@30V<sub>DC</sub>
- Relay-on time 3 ms
- Relay-off time 5 ms
- Electrical endurance at contact application Resistive, 0.25A@250V<sub>AC</sub>:  
1x10<sup>6</sup> operations/min.  
Resistive, 2A@30V<sub>DC</sub>:  
1x10<sup>6</sup> operations/min.
- Insulation Resistance 1 GΩ

### Digital Input

- Channels 18
- Dry contact logic 0: Open  
logic 1: Closed to ground
- Wet contact logic 0: 0 ~ 3 V<sub>DC</sub> or floating  
logic 1: 10 ~ 30 V<sub>DC</sub>  
Support DO type:  
Sink (NPN) and Source (PNP)
- DI12~DI17 support 3 kHz counter input
- DI12~DI17 support 3 kHz frequency input

### Digital Output

- Channels 6
- Output type Sink type, 30 V<sub>DC</sub>,  
0.1A max. per channel
- DO0~DO5 support 3 kHz pulse output

## Common Specifications

### General

- Power input 10 ~ 30 V<sub>DC</sub>
- Power Consumption 2.8 W @ 24 V<sub>DC</sub> (ADAM-6350)  
2.8 W @ 24 V<sub>DC</sub> (ADAM-6360D)  
4.5 W @ 24 V<sub>DC</sub> (ADAM-6366)
- LAN port 2-port 10/100 Base-T(X)  
(for Daisy Chain)
- Connectors 2 x RJ-45 (LAN), Plug-in screw terminal block (I/O and power)
- Watchdog Protocol System and Communication  
OPC UA, Modbus

### Protection

- Isolation 2,500 V<sub>DC</sub>
- Power Reversal Protection

### OPC UA

- Max Monitored Items 600  
(including all sessions)
- Max Sessions 4  
(including security or non-security session)
- Max Subscriptions per Session 1
- Support security/certificate management

### Modbus/TCP

- Modbus/TCP connection 4

### Environment

- Operating Temperature -25°C ~ 70°C
- Storage Temperature -25°C ~ 85°C
- Operating Humidity 20 ~ 95% RH  
(non-condensing)
- Storage Humidity 0 ~ 95% RH  
(non-condensing)

## Ordering Information

- ADAM-6350-A1 OPC UA and Security Remote I/O - DI/O Module
- ADAM-6360D-A1 OPC UA and Security Remote I/O - SSR Relay Output Module
- ADAM-6366-A1 OPC UA and Security Remote I/O - SSR Relay Output Module

# Ethernet I/O Modules: ADAM-6000/6200/6300

## Introduction

Advantech's ADAM-6000/6200/6300 Ethernet I/O modules are easily integrated so they can remotely monitor and control devices more flexibly.

## Feature Highlights

### Secured Cloud I/O

Innovative ADAM-6000/6200 Secured Cloud I/O offers device management, OTA updates, security and device monitoring functions in IoT era and help user easily manage widespread assets across diverse applications

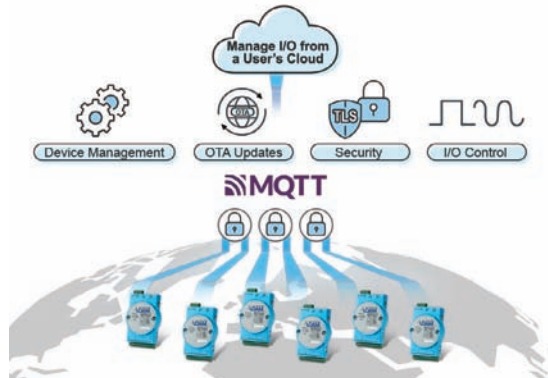

- **Device Management:** UUID, networking setting, I/O channel configuration
- **OTA Updates:** firmware, certificate and configuration mass deployment
- **Security:** TLS, X.509 certificate, cipher suites, IP whitelisting, protocol disabled
- **I/O Control:** digital I/O on/off, analog I/O read/write, I/O value periodically updated, alarm notification

### Simple and Intuitive Logic Control

ADAM-6000/6200 Peer-to-Peer (P2P) and Graphic Condition Logic (GCL) modules can perform as standalone products for measurement, control, and automation.

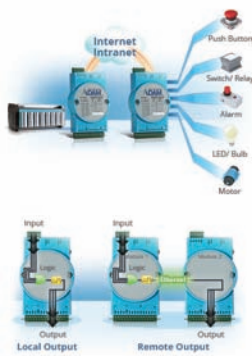

#### Peer-to-Peer (P2P) connection

- Easy channel mapping from different I/O modules without extra programming effort or additional controllers.
- Utilizes Peer-to-Peer modules, just configure settings through ADAM.NET utility.

#### Graphic condition logic (GCL)

- GCL function is built-in ADAM-6000 and ADAM-6200 modules for users to easily set up logic rules in any application.
- User defined logic rules through graphical configuration environment in ADAM.NET utility.
- No additional controllers or programming is needed.

### Easy Deployment and Robust Communication



#### Flexible deployment with daisy chain networking and auto-bypass protection

ADAM-6200/6300 series supports daisy chain connectivity that offers flexible cabling and space saving capabilities. With Ethernet auto-bypass function supported to prevent accidental power failures if one of the modules unexpectedly shuts down.

### Rich IoT Protocols

The ADAM-6000/6200 series supports multiple protocols for IoT applications: MQTT, SNMP, Restful APIs, and Modbus, which are very flexible and can be easily integrated with Microsoft Azure, Database, Network and SCADA systems.



#### Cloud

- Supports Azure IoT Hub

#### MQTT

- Actively publish MQTT messages with user defined intervals.
- Shortens downtime with alarm event notification.
- Privacy assured with the TLS (Transport Layer Security).
- User defined topic to integrate existing systems.

#### SNMP

- Simple way to monitor I/O data on NMS (Network Management System).
- SNMP trap to notify alarm events.
- Reduces implementation cost with ADAM MIB (Management Information Base) file.

### Industrial Grade with Isolation & Wide-operating Temperature

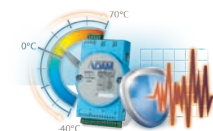

ADAM-6000/6200/6300 series has a rugged design.

- Supports isolation protection to avoid system damage from high-energy noise.
- Supports operating temperatures of between -40 ~70°C and can perform in most harsh environments.

### Application Structure

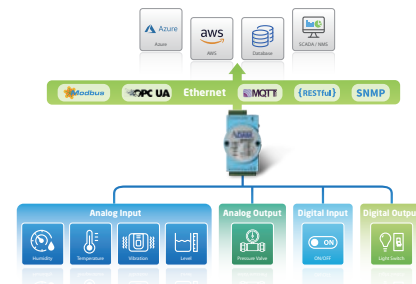

### ADAM-6000/6200/6300 Series Comparison

Series Name	ADAM-6000 Series	ADAM-6200 Series	ADAM-6300 Series	
Daisy-chain Connectivity	-	✓	✓	
Protocol	MQTT	✓	-	
	SNMP	✓	-	
	Modbus	✓	✓	
	RESTful	✓	-	
	OPC UA	-	-	✓
	Cloud I/O	✓	✓	(By request)

# Ethernet I/O Modules: ADAM-6000



Model		ADAM-6015	ADAM-6017	ADAM-6018+	ADAM-6022	ADAM-6024
Interface		1x RJ-45 LAN port, 10/100 Mbps Ethernet				
Peer-to-Peer <sup>1</sup>			✓		-	Receiver Only <sup>2</sup>
GCL <sup>1</sup>			✓		-	Receiver Only <sup>2</sup>
Resolution			16-bit		16-bit for analog inputs 12-bit for analog outputs	16-bit for analog inputs 12-bit for analog outputs
Analog Input	Channels	7	8	8	6	6
	Sampling Rate	10 Hz	10/100 Hz	10 Hz	10 Hz	10 Hz
	Voltage Input	-	±150 mV, ±500 mV, ±1 V, ±5 V, ±10 V, 0~150 mV, 0~500 mV, 0~1 V, 0~5 V, 0~10 V	-	±10 V	±10 V
	Current Input	-	0~20 mA, 4~20 mA, ±20 mA	-	0~20 mA, 4~20 mA	0~20 mA, 4~20 mA
	Direct Sensor Input	Pt, Balco, and Ni RTD	-	J, K, T, E, R, S, B thermocouple	-	-
	Burn-out Detection	✓	✓ (4 ~ 20mA only)	✓	-	-
	Math. Functions	Max. Min. Avg.	Max. Min. Avg.	Max. Min. Avg.	-	-
Analog Output	Channels	-	-	-	2	2
	Current Output	-	-	-	0~20, 4~20 mA @ 15 V <sub>DC</sub>	0~20, 4~20 mA @ 15 V <sub>DC</sub>
	Voltage Output	-	-	-	0~10 V <sub>DC</sub> @ 30 mA	0~10 V <sub>DC</sub> @ 30 mA
Digital I/O	Input Channels	-	-	-	2	2
	Output Channels	-	2 (sink)	8 (sink)	2 (sink)	2 (sink)
	High/Low Alarm Settings	✓	✓	✓	-	-
Isolation Protection			2,000 V <sub>DC</sub>		2,000 V <sub>DC</sub>	2,000 V <sub>DC</sub>
Remark					Built-in dual loop PID control algorithm	
Protocol		D version: Modbus TCP, RESTful, MQTT, SNMP, ASCII			Modbus TCP	D version: Modbus TCP, RESTful, MQTT, SNMP, ASCII
Certification		CID2, UL, CE, FCC	CID2, UL, CE, FCC	UL, CE, FCC	CE, FCC	UL, CE, FCC



Model		ADAM-6050	ADAM-6051	ADAM-6052	ADAM-6060	ADAM-6066
Interface		1x RJ-45 LAN port, 10/100 Mbps Ethernet				
Peer-to-Peer <sup>1</sup>		✓	✓	✓	✓	✓
GCL <sup>1</sup>		✓	✓	✓	✓	✓
Digital I/O	Input Channels	12	12	8	6	6
	Output Channels	6 (sink)	2 (sink)	8 (source)	6-ch relay	6-ch power relay
	Extra Counter Channels	-	2	-	-	-
	Counter Input	3 kHz	4.5 kHz	3 kHz	3 kHz	3 kHz
	Frequency Input	3 kHz	4.5 kHz	3 kHz	3 kHz	3 kHz
	Pulse Output	✓	✓	✓	✓	✓
	High/Low Alarm Settings	-	-	-	-	-
Isolation Protection		2,000 V <sub>DC</sub>				
Protocol		D version: Modbus TCP, RESTful, MQTT, SNMP, ASCII				
Certification		CID2, UL, CE, FCC	UL, CE, FCC	CID2, UL, CE, FCC	UL, CE, FCC	UL, CE, FCC

✓: supported, -: not supported, Δ: optional

# Ethernet I/O Modules: ADAM-6200



Model	ADAM-6217	ADAM-6224	ADAM-6250	ADAM-6251	ADAM-6256	ADAM-6260	ADAM-6266	
Interface	2x RJ-45 LAN port (Daisy-chain), 10/100 Mbps Ethernet							
Peer-to-Peer <sup>1</sup>	✓	Receiver Only <sup>2</sup>	✓	✓	✓	✓	✓	
GCL <sup>1</sup>	✓	✓	✓	✓	✓	✓	✓	
Analog Input	Channels	8	-	-	-	-	-	
	Input Impedance	>10M $\Omega$ (voltage) 120 $\Omega$ (current)	-	-	-	-	-	
	Voltage Input	$\pm$ 150 mV, $\pm$ 500 mV, $\pm$ 1 V, $\pm$ 5 V, $\pm$ 10 V	-	-	-	-	-	
	Current Input	0~20 mA, 4~20 mA, $\pm$ 20 mA	-	-	-	-	-	
	Sampling Rate	10 Hz	-	-	-	-	-	
	Burn-out Detection	✓ (4~20 mA)	-	-	-	-	-	
	Resolution	16-bit	-	-	-	-	-	
Accuracy	$\pm$ 0.1% of FSR (voltage) @ 25°C $\pm$ 0.2% of FSR (current) @ 25°C	-	-	-	-	-	-	
Analog Output	Channels	-	4	-	-	-	-	
	Voltage Output	-	0~5 V, 0~10 V, $\pm$ 5 V, $\pm$ 10 V	-	-	-	-	
	Current Output	-	0~20 mA, 4~20 mA	-	-	-	-	
	Resolution	-	12-bit	-	-	-	-	
Digital I/O	Input Channels	-	4 (dry contact only)	8	16	-	4	
	Output Channels	-	-	7 (sink)	-	16 (sink)	-	
	Relay Output	-	-	-	-	-	1 x Form A, 5 x Form C	4 x Form C
	Contact Rating	-	-	-	-	-	250 V <sub>AC</sub> @ 5A 30 V <sub>DC</sub> @ 5A	
	Counter Input	-	-	3 kHz	3 kHz	-	-	3 kHz
	Frequency Input	-	-	3 kHz	3 kHz	-	-	3 kHz
	Pulse Output	-	-	5 kHz	-	5 kHz	5 kHz	5 kHz
	LED Indicators	-	-	8 digital outputs, 7 digital inputs	16 digital inputs	16 digital outputs	6 relay	4 digital inputs, 4 relay
Power Consumption	3.5 W	6 W	3 W	2.7 W	3.2 W	4.5 W	4.2 W	
Isolation Voltage	2,500 V <sub>DC</sub>							
Watchdog Timer	System (1.6 s), Communication (programmable)							
Communication Protocol	Modbus TCP, RESTful, MQTT, SNMP, ASCII							
Power Requirements	10~30 V <sub>DC</sub> (24 V <sub>DC</sub> standard)							
Operating Temperature	-40~70 °C (-40~158 °F)							
Storage Temperature	-40~85 °C (-40~185 °F)							
Operating Humidity	20~95% RH (non-condensing)							
Storage Humidity	0~95% RH (non-condensing)							
Certification	UL, CE, FCC	UL, CE, FCC	UL, CE, FCC	UL, CE, FCC	UL, CE, FCC	UL, CE, FCC	UL, CE, FCC	

Note 1: Peer-to-peer and GCL cannot be run simultaneously; only one feature can be enabled at a time.

Note 2: The ADAM-6224 can only act as a receiver and generate analog output when peer-to-peer or GCL mode is used.

✓: supported, -: not supported,  $\Delta$ : optional

# OPC UA Ethernet I/O Modules: ADAM-6300



Model		ADAM-6315	ADAM-6317	ADAM-6318	ADAM-6324	ADAM-6350	ADAM-6360D	ADAM-6366	
Description		IoT OPC UA Ethernet I/O - RTD Input Module	IoT OPC UA Ethernet I/O - Analog Input Module	IoT OPC UA Ethernet I/O - T/C Input Module	IoT OPC UA Ethernet I/O - Analog Output Module	IoT OPC UA Ethernet I/O - Digital I/O Module	IoT OPC UA Ethernet I/O - SSR Relay Output Module	IoT OPC UA Ethernet I/O - Relay Output Module	
General	Power Input	10~30 V <sub>DC</sub>							
	LAN Port	2 x RJ-45 10/100 Mbps							
	Connectors	2 x RJ-45 (LAN), Plug-in screw terminal block (I/O and power)							
	Watchdog	System and Communication							
Protection	Protocol	OPC UA, Modbus TCP							
	Isolation	2500 V <sub>DC</sub>							
	Power Reversal Protection	Yes							
OPC UA	Max Monitored Items	600 (including all sessions)							
	Max Sessions	4 (including security or non-security session)							
	Max Subscriptions per Session					1			
	Support Security/Certificate Management					Yes			
Modbus TCP Connections		4							
Environment	Operating Temperature	-25° C~70° C (-13~158 °F)							
LED Indicator		Status, Error, Link, Active							
Analog Input	Channels	8	8	7	-	-	-	-	
	Voltage Input	RTD: Pt 100, Pt 1000, Balco 500, Ni 518	0~150mV, 0~500mV, 0~1V, 0~5V, 0~10V, ±150 mV, ±500 mV, ±1V, ±5 V, ±10 V	Thermocouple: J, K, T, E, R, S, B	-	-	-	-	
	Current Input	-	0 ~ 20 mA, 4 ~ 20 mA, ± 20 mA	-	-	-	-	-	
	Sampling Rate	10 Hz (total)	10/100 Hz (total)	10 Hz (total)	-	-	-	-	
	Burn-out Detection	Yes	Yes (4~20 mA)	Yes	-	-	-	-	
	Resolution	16-bit	16-bit	16-bit	-	-	-	-	
Digital Input	Digital Input Channels	10	11	10	11	18	14	18	
	Counter Input	3 kHz (DI4~DI9)	3 kHz (DI5~DI10)	3 kHz (DI4~DI9)	3 kHz (DI5~DI10)	3 kHz (DI12~DI17)	3 kHz (DI8~DI13)	3 kHz (DI12~DI17)	
	Frequency Input	3 kHz (DI4~DI9)	3 kHz (DI5~DI10)	3 kHz (DI4~DI9)	3 kHz (DI5~DI10)	3 kHz (DI12~DI17)	3 kHz (DI8~DI13)	3 kHz (DI12~DI17)	
Digital Output	Digital Output Channels	10	10	13	12	18	6	6	
	Relay Output Channels	-	-	-	-	-	8 x Form A (SSR)	6 x Form A	
	Contact Rating	-	-	-	-	-	1 A @25°C @ 30 V <sub>DC</sub> 0.7A @70°C @30 V <sub>DC</sub>	250 V <sub>AC</sub> @ 0.25 A, 30 V <sub>DC</sub> @ 2 A	
	Pulse Output	3 kHz (DO4~DO9)	3 kHz (DO4~DO9)	3 kHz (DO7~DO12)	3 kHz (DO6~DO11)	3 kHz (DO12~DO17)	3 kHz (DO0~DO5)	3 kHz (DO0~DO5)	
Analog Output	Channels	-	-	-	4	-	-	-	
	Type	-	-	-	0~5 V, 0~10 V, ± 5 V, ± 10 V, 0~20 mA, 4~20 mA	-	-	-	
Certification		CE, FCC	CE, FCC	CE, FCC	CE, FCC	CE, FCC	CE, FCC	CE, FCC	

勝特力電材超市-龍山店 886-3-5773766  
 勝特力電材超市-光復店 886-3-5729570  
 勝特力電子(上海) 86-21-34970699  
 勝特力電子(深圳) 86-755-83298787  
<http://www.100y.com.tw>

✓: supported, -: not supported, Δ: optional