

勝特力材料 886-3-5753170
勝特力电子(上海) 86-21-54151736
勝特力电子(深圳) 86-755-83298787
[Http://www.100y.com.tw](http://www.100y.com.tw)

圓形工業連接器

Circular Connectors

Industrial High Reliability Interconnect Solutions



ISO 9001 • ISO 14001

C 12.46

CR Series CR系列

- Solid metal shell construction
- Threaded coupling & color coded ring option
- Cost effective for industrial grade application

- Key polarization and alternate position
- Gold plated & solder contact terminals
- UL certified

No. of contacts 接點數及電氣規格:









CR2: 2, 3 (pins) 4, 7	15A / 250V 10A / 250V	CR4: 12, 16, 17 (pins) 20, 26	8A / 250V 4A / 250V
CR3: 10 (pins) 16	10A / 250V 4A / 250V	CR5: 24 (pins)	8A / 250V



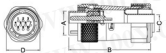
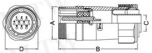

Series 規格系列	CRxR Box Mounting (Square Flange) 方型蓋板座						CRxA Box Mounting (Round Flange w/hex lock nut) 圓型蓋板座					CRxD Wall Mounting w/backshell (Square Flange) 方型蓋板座 (夾線型)				
	Male (♂)			Female (♀)			Male (♂)		Female (♀)			Male (♂)		Female (♀)		
Connector Style 外型式樣																
Outer Dimension of Connector 外型尺寸																
	A	B	C	D	E	F	A	B	C	D	E	A	B	C	D	E
CR2	21.8	26.4	so 23.0	so 29.0	3.3	19.8	21.8	26.4	9.9	28.5	19.8	21.8	47.8	so 23.0	so 29.0	3.3
CR3	25.8	26.8	so 26.0	so 32.0	3.3	24.0	25.8	26.8	10.3	31.5	24.0	25.8	53.4	so 26.0	so 32.0	3.3
CR4	29.8	26.8	so 29.0	so 35.0	3.3	27.6	29.8	26.8	10.5	34.5	27.6	29.8	55.0	so 29.0	so 35.0	3.3
CR5	37.8	40.0	so 35.0	so 44.8	3.3	34.9	-	-	-	-	-	-	-	-	-	-

Series 規格系列	CRxF Wall Mounting w/backshell (Round Flange w/hex lock nut) 圓型蓋板座 (夾線型)				CRxP-10 Straight Plug w/bushing 直線型插線接頭 (夾線式)				CRxE-10 Cable Extender w/bushing 延長型插線接頭 (夾線式)			
	Male (♂)		Female (♀)		Male (♂)		Female (♀)		Male (♂)		Female (♀)	
Connector Style 外型式樣												
Outer Dimension of Connector 外型尺寸												
	A	B	C	D	A	B	C	D	A	B	C	D
CR2	21.8	48.7	13.0	28.5	16.0	50.0	8.5	25.5	21.8	48.7	8.5	23.5
CR3	25.8	53.4	13.4	31.5	20.5	53.0	9.8	30.0	25.8	53.4	9.8	27.0
CR4	29.8	55.0	17.0	34.5	24.5	56.0	12.5	33.8	29.8	55.0	12.5	31.5
CR5	-	-	-	-	32.7	70.0	16.5	43.0	-	-	-	-

圖形工業連接器

Series 規格系列	CRxP-20 Straight Plug (or flexible conduit) 套環型接線接頭 (浪管式)				CRxE-20 Cable Extender (For flexible conduit) 延長型接線接頭 (浪管式)				CRxP-Bxx Straight Plug (w/ plastic cable gland clamp) 套環型接線接頭 (塑膠束線式)			
	Male (♂)		Female (♀)		Male (♂)		Female (♀)		Male (♂)		Female (♀)	
Connector Style 外型式樣												
Outer Dimension of Connector 外型尺寸												
	A	B	C	D	A	B	C	D	A	B	C	D
CR2	16.0	57.5	11.3	25.5	21.8	56.5	11.3	23.5	16.0	78.4	12.0	27.0
CR3	20.5	62.5	11.3	30.0	25.4	62.8	11.3	27.0	20.5	84.5	12.0	27.0
CR4	24.5	62.5	14.7	33.8	29.8	61.0	14.7	31.5	24.5	88.3	16.0	33.0
CR5	-	-	-	-	-	-	-	-	-	-	-	-

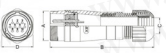
Series 規格系列	CRxE-Bxx Cable Extender (w/ plastic cable gland clamp) 延長型接線接頭 (塑膠束線式)			
	Male (♂)		Female (♀)	
Connector Style 外型式樣				
Outer Dimension of Connector 外型尺寸				
	A	B	C	D
CR2	21.8	77.8	12.0	27.0
CR3	25.8	85.0	12.0	27.0
CR4	29.8	87.6	16.0	33.0
CR5	-	-	-	-

圓形工業連接器

CS Series 系列

- Solid metal shell construction
- Threaded coupling hard dielectric inserts
- Cost effective for industrial grade application

- Front Key polarization
- Solder contact terminals
- UL certified





No. of contacts 接點數及電氣規格:





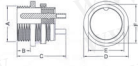
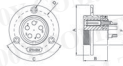
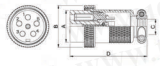

CS1: 2, 3, 4, 5, 6, 7, 8 (pins)	5A / 125V
CS2: 2, 3, 4 (pins)	5A / 125V
CS3: 2, 3, 4, 5, 6, 7 (pins)	10A / 250V
CS4: 2·3·4·5·7 (pins)	15A / 250V
8	5A / 250V
CS5: 1 (pin)	250A / 250V
2, 3 (pins)	30A / 250V

CS6: 4 (pin)

30A / 250V

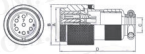
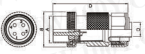
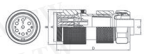

Series 規格系列	CSxA Box Mounting Round Flange w/Hex Lock Nut 圓型盒板座						CSxR Box Mounting (Flange) 圓型盒板座						CSxP Straight Plug 直型型線插頭 (線管式)			
	Male (♂)						Male (♂)			Female (♀)			Male (♂)		Female (♀)	
Connector Style 外型式樣																
Outer Dimension of Connector 外型尺寸																
	A	B	C	D	E	F	A	B	C	D	E	F	A	B	C	D
CS1	15.7	5.4	20.5	18.3	14.5	15.7	-	-	-	-	-	-	12.5	18.0	6.6	36.0
CS2	-	-	-	-	-	-	33.0	25.0	120	25.5	3.3	18.9	15.5	22.0	9.0	43.0
CS3	-	-	-	-	-	-	42.2	27.5	120	33.5	3.3	24.9	21.1	27.7	10.8	50.3
CS4	-	-	-	-	-	-	46.0	29.3	120	36.0	3.3	30.0	25.6	33.0	12.0	54.8
CS5	-	-	-	-	-	-	51.0	35.5	120	42.0	3.3	32.0	27.7	38.0	15.5	64.5
CS6	-	-	-	-	-	-	58.0	36.6	120	50.0	3.3	40.0	35.0	46.0	16.4	69.0

Series 規格系列	CS x E Cable Extender 延長型線插頭 (夾線式)				CSxP-20 Straight Plug (For flexible conduit) 直型型線插頭 (溝管式)				CS x E-20 Cable Extender 延長型線插頭 (溝管式)			
	Male (♂)		Female (♀)		Male (♂)		Female (♀)		Male (♂)		Female (♀)	
Connector Style 外型式樣												
Outer Dimension of Connector 外型尺寸												
	A	B	C	D	A	B	C	D	A	B	C	D
CS1	15.7	17.8	6.6	43.8	-	-	-	-	-	-	-	-
CS2	-	-	-	-	21.1	27.7	11.3	60.0	24.8	28.7	11.3	60.2
CS3	24.8	28.7	10.8	57.4	25.6	33.0	11.3	60.0	29.0	34.0	11.3	65.3
CS4	29.0	34.0	12.0	63.5	-	-	-	-	-	-	-	-
CS5	-	-	-	-	-	-	-	-	-	-	-	-
CS6	-	-	-	-	-	-	-	-	-	-	-	-

CM Series CM系列

- Subminiature size metal shell construction
- Threaded coupling and gold plated contacts
- Cost effective for instrument application
- Solder contacts and molded on wire options

No. of contacts 接點數及電氣規格：

CM1 : 3, 4, 5 (pins) 2A / 125V



Series 規格系列	CMxA Box Mounting w/Hex Nut 面板座		CMxP-10 Straight Plug 直線型接線接頭		CMxE-10 Cable Extender 延長型接線接頭							
	Male (♂)	Female (♀)	Male (♂)	Female (♀)	Male (♂)	Female (♀)						
Connector Style 外型式樣												
Outer Dimension of Connector 外型尺寸												
	A	B	C	D	A	B	C	D				
CM1	9.5	6.6	17.8	10.0	7.5	46.5	4.0	11.4	9.5	6.6	44.6	4.0

Series 規格系列	CMxP-MD Straight Plug (w/Solder Cable Mounting) 直線型接線接頭 (含線成型)		CMxE-MD Cable Extender (w/Solder Cable) 延長型接線接頭 (含線成型)					
	Male (♂)	Female (♀)	Male (♂)	Female (♀)				
Connector Style 外型式樣								
Outer Dimension of Connector 外型尺寸								
	A	B	C	D	A	B	C	D
CM1	7.5	16.0	4.0	11.4	9.5	6.6	16.0	4.0

圓形工業連接器

CT Series CT系列

- Robust Aluminum alloy shell construction
- Threaded coupling conform IP-67
- Heavy duty for industrial grade application
- Front Key polarization and alternate positions
- Hard gold plated Solder center terminals

No. of contacts 接點數及電氣規格:

CT4 : 19 (pins) 25A / 250V



Series 規格系列	CT4R		CT4C		CT4E-S0		CT4P-S0		CT4E-L0		CT4P-L0													
	Box / Wall Mounting (Screw Flange) 盒板蓋				Short Backshell (w/plastic cable gland clamp) 接線短柄接頭				Long Backshell (w/plastic cable gland clamp) 接線長柄接頭															
Contact	Female Receptacle (母)		Male Plug (公)		Female Cable Extender (母)		Male Straight Plug (公)		Female Cable Extender (母)		Male Straight Plug (公)													
Connector Style 外型式樣																								
Outer Dimension of Connector 外型尺寸																								
CT4	A	B	C	D	A	B	C	D	A	B	C	D	A	B	C	D	A	B	C	D	A	B	C	D
	45.8	25.7	iso 41	iso 56	50.0	35.8	iso 41	iso 56	45.8	87.5	26.5	56.6	50.0	93.0	26.5	64.0	45.8	127	26.5	56.6	50.0	135	26.5	64.3

Series 規格系列		CR / CS Dust Cap 防塵蓋											
Contact		Metal Cap 金屬蓋				Plastic Cap 塑膠蓋				Rubber Dust Cap 橡膠防塵蓋			
Cap Style 外型式樣													
Outer Dimension 外型尺寸													
		A	B	C	D	A	B	C	D	A	B	C	D
CR	CR2	25.5	M22*1.0	7.2	5.3	28.0	M22*1.0	9.0	5.3	20.8	19.6	-	SQ23
	CR3	28.5	M26*1.0	8.2	5.3	32.0	M26*1.0	9.0	5.3	24.8	23.8	-	SQ26
	CR4	34.0	M30*1.0	8.2	5.3	36.0	M30*1.0	9.0	5.3	28.8	27.3	-	SQ29
	CR5	-	-	-	-	-	-	-	-	36.8	34.6	-	SQ35
CS	CS2	-	-	-	-	-	-	-	-	17.8	18.6	120	25.5
	CS3	28.5	M25*1.25	8.2	5.3	32.0	M25*1.25	9.0	5.3	23.8	25.0	120	33.8
	CS4	34.0	M29*2*1.0	8.2	5.3	36.0	M29*2*1.0	9.0	5.3	28.0	30.0	120	38.0
	CS5	-	-	-	-	-	-	-	-	32.8	31.6	120	42.0
	CS6	-	-	-	-	-	-	-	-	40.2	39.5	120	50.0

CR Series --Mating Styles Configuration

對接式樣圖

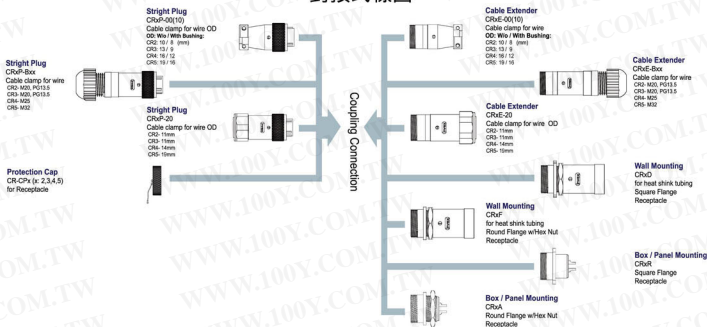

Part No. Code : 型號編碼表

CR Series

CR 2 P - 07 A P N S - 10

CR Series
Shell Size : 2,3,4,5
型號大小

Connector Type
P : Straight Plug
R : Receptacle Box Mount Screw Flange (D with backshell for heatshrink tubing)
A : Receptacle w/Hex Nut Flange (F with backshell for heatshrink tubing)
E : Cable Extender
外型代碼

Contact No.
接觸點

Insert Arrangement : A - Z
接觸點排列順序代碼

Contact Type
P : Male
S : Female
公母代碼

Alternate Position
N : Normal
W.X.Y.Z : Front face of an insert rotation
90° 120° 150° 230° (CR only)
接觸點轉角代碼

Shell Finish
S : Silver Color
B : Black Color
外殼顏色

Cable Clamp Type
00 : STD Cable Clamp
10 : Clamp with Bushing
20 : Flat Conduit Type
B20 : M20 Plastic Clamp Black (CS/B20)
G20 : M20 Plastic Clamp Gray (CS/G20)
W20 : M20 Plastic Clamp White (CS/W20)
B25 : M25 Plastic Clamp Black (CS/B25)
G25 : M25 Plastic Clamp Gray (CS/G25)
W25 : M25 Plastic Clamp White (CS/W25)
B32 : M32 Plastic Clamp Black (CS/B32)
G32 : M32 Plastic Clamp Gray (CS/G32)
W32 : M32 Plastic Clamp White (CS/W32)
型號編碼代碼

CS Series

CS 3 P - 04 A P N S - 00

CS Series
Shell Size : 1,2,3,4,5,6
型號大小

Connector Type
P : Straight Plug
R : Receptacle Box Mount Screw Flange (D with backshell for heatshrink tubing)
A : Receptacle w/Hex Nut Flange (F with backshell for heatshrink tubing)
E : Cable Extender
外型代碼

Contact No.
接觸點

Insert Arrangement : A - Z
接觸點排列順序代碼

Contact Type
P : Male
S : Female
公母代碼

STD Alternate Position : N
接觸點轉角代碼

Shell Finish
S : Silver Color
B : Black Color
外殼顏色

Cable Clamp Type
00 : STD Cable Clamp
10 : Clamp with Bushing
20 : Flat Conduit Type
B20 : M20 Plastic Clamp Black (CS/B20)
G20 : M20 Plastic Clamp Gray (CS/G20)
W20 : M20 Plastic Clamp White (CS/W20)
B25 : M25 Plastic Clamp Black (CS/B25)
G25 : M25 Plastic Clamp Gray (CS/G25)
W25 : M25 Plastic Clamp White (CS/W25)
型號編碼代碼

CT Series

CT 4 P - 19 A P N S - L0

CT Series
Shell Size : 4
型號大小

Connector Type
P : Straight Plug
R : Receptacle Box Mount Screw Flange
C : Box Mount Screw Flange Plug Type
E : Cable Extender
外型代碼

Contact No.
接觸點

Insert Arrangement : A - Z
接觸點排列順序代碼

Contact Type
P : Male
S : Female
公母代碼

STD Alternate Position : N
接觸點轉角代碼

Shell Finish
S : Silver Color
B : Black Color
G : Gold Color
外殼顏色

Cable Clamp Type
L0 : Long Shell Type + Black Plastic Clamp
S0 : Short Shell Type + Black Plastic Clamp
型號編碼代碼

CM Series

CM 1 P - 05 A P N S - 10

CM Series
Shell Size : 1
型號大小

Connector Type
P : Straight Plug
A : Box Mount Screw Flange Plug Type
E : Cable Extender
外型代碼

Contact No.
接觸點

STD. Insert Arrangement : A
接觸點排列順序代碼

Contact Type
P : Male
S : Female
公母代碼

STD. Alternate Position : N
接觸點轉角代碼

Shell Finish
S : Silver Color
B : Black Color
外殼顏色

10 : Cable Bushing
M0 : Cable Mounting
型號編碼代碼

線規對照表

Conversion Chart of American Wire Gauge

美規線號	耐電流 (A)		平方值		導體直徑	
Size AWG or MCM	Amperes Single Cond. 75°C Copper (NFPA)	Circular Mils	Area Square Inches	Square mm	Inches ClassM (NEMA)	Approx Diameter (mm)
20	7	1020	0.0008	0.52	0.038	0.97
18	10	1620	0.0013	0.82	0.048	1.22
16	15	2580	0.0020	1.31	0.060	1.52
14	20	4110	0.0032	2.08	0.078	1.98
12	25	6530	0.0051	3.31	0.101	2.57
10	40	10380	0.0082	5.26	0.126	3.20
8	65	16510	0.0130	8.37	0.162	4.11
6	95	26240	0.0206	13.30	0.215	5.46
4	125	41740	0.0328	21.15	0.269	6.83
2	170	66360	0.0521	33.62	0.337	8.56
1	195	83690	0.0657	42.41	0.376	9.55
1/0	230	105600	0.0829	53.50	0.423	10.74
2/0	265	133100	0.1045	67.43	0.508	12.90
3/0	310	167800	0.1318	85.01	0.576	14.63
4/0	360	211800	0.1662	107.20	0.645	16.38
250 MCM	405	250000	0.1964	126.70	0.713	18.11
300 MCM	445	300000	0.2356	152.00	0.768	19.51
500 MCM	620	500000	0.3927	253.40	0.997	25.32
750 MCM	785	750000	0.5891	380.00	1.207	30.66
1000 MCM	935	1000000	0.7854	506.70	1.404	35.66

各型工業應用連接器系列



機箱背板連接器



美規NEMA電源連接器



軍規圓型連接器



單極大電流電源連接器



直流電源連接器



歐規CEE電源連接器



WA塑膠圓型連接器



電路旋轉連接器



電路接線端子台