

勝特力電材超市-龍山店 886-3-5773766
勝特力電材超市-光復店 886-3-5729570
勝特力電子(上海) 86-21-34970699
勝特力電子(深圳) 86-755-83298787
<http://www.100y.com.tw>

测试附件 主目录

测试与测量

CN

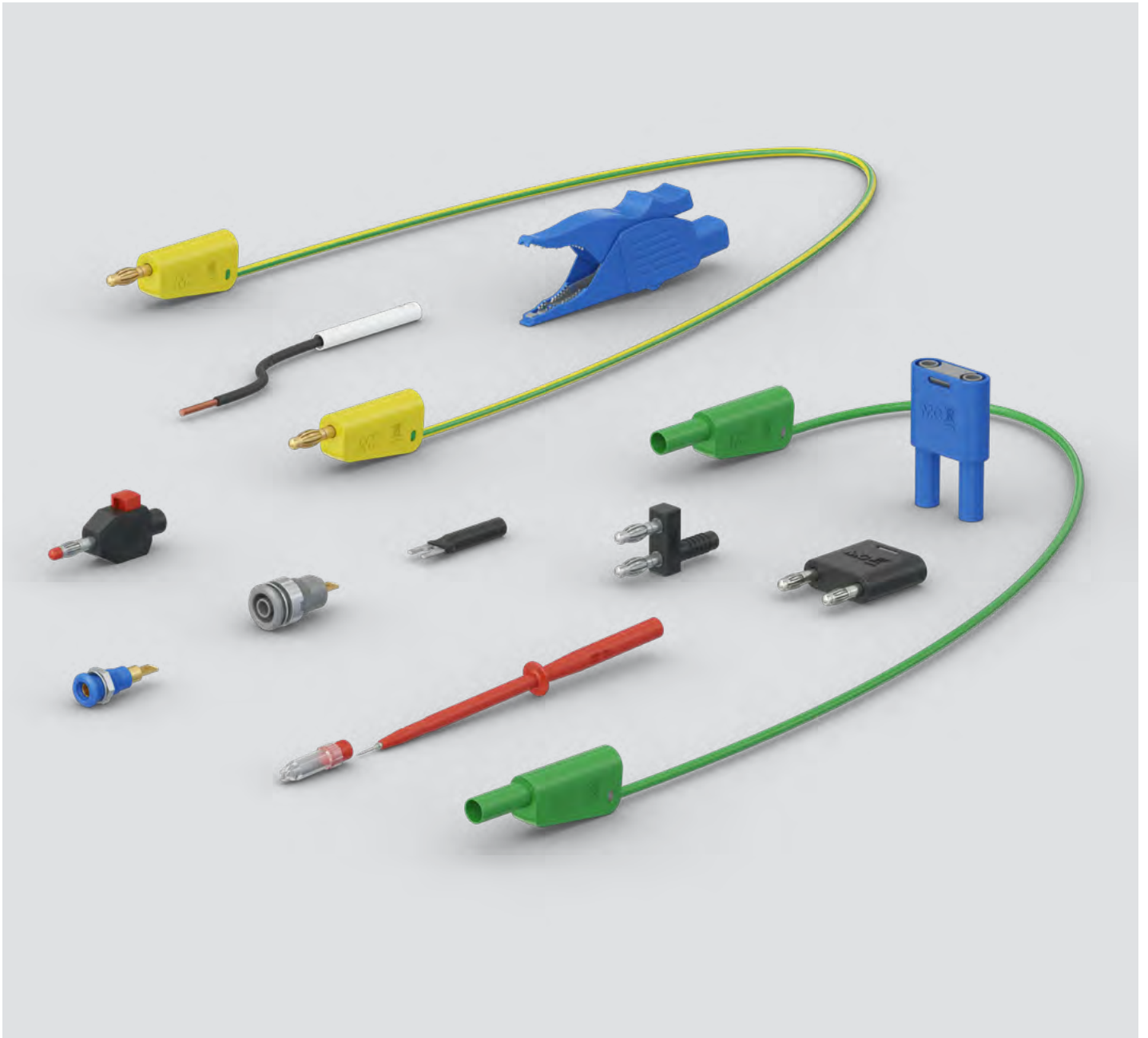

史陶比尔电连接器 连接美好生活



史陶比尔集团是电连接器、流体连接器、机器人和纺织机械这四大事业部构成的机电一体化解决方案的全球专业供应商。史陶比尔电连接器事业部基于可靠的 MULTILAM 技术研发先进连接解决方案。

携手迈向可靠和安全的连接

您愿意将功能开发需求托付给史陶比尔，这是对我们的极大认可，我们每天都在努力以赢得这份信任。得益于丰富的专业知识、行业经验和成功案例，史陶比尔电连接器事业部开发了众多原创产品，并在日后发展成为行业标杆。史陶比尔MC4系列光伏连接器就是

史陶比尔以客户为中心，为美好生活提供连接解决方案。我们坚信，长期稳固的合作伙伴关系能够实现互利共赢。

我们致力于满足合作伙伴的需求，并应对最棘手的挑战。因此，在研发、销售和技术支持

一个典型案例，目前已经成为全球市场领导者。作为史陶比尔的原创之作，MC4代表了我們不断追求创新、质量和安全的精神。

类似的案例还有CombiTac模块化连接器系统以及应用于自动充电系统的QCC快速充电连接器

史陶比尔与长期客户通力合作，为可再生能

等方面，我们始终与客户保持密切合作，以便为要求高生产力和安全标准的市场提供可靠而持久的解决方案。

源、工业自动化、输配电、铁路、焊接自动化、测试测量、医疗设备和电动交通等行业提供连接解决方案。史陶比尔，连接美好生活。

基于久经考验的MULTILAM技术研发可靠、高效和安全的解决方案，不仅能够实现高效的能量传输，还可以保证长久的使用寿命。

应用和优势



在本主目录中将展示我们种类繁多且带触摸保护的测试附件, 其符合 IEC/EN 61010-031 除了面向服务技术人员 (CAT II)、电气和电力公司员工 (CAT III 和 CAT IV) 的手持式附件,

本目录还包含我们的 AC 30 V/DC 60 V 产品系列。测试附件配有符合 IEC / EN 61010-1 的测试和测量设备的安全接线插座。

了解更多测试与测量产品组合信息, 请访问我们的网站:

 了解更多



目录

页 6	通用信息 测量种类	页 122	装配部件和附件 <ul style="list-style-type: none">• 六角螺母• 圆形螺母• 垫圈• 弹簧垫圈• 保护帽• 安全罩• 平面连接插座• 管状扳手• 六角扳手• 压入工具• 高熔断保险丝• 测试导线夹持器
页 8	Ø 1 mm系统 <ul style="list-style-type: none">• 综述• 测试导线• 自组装插头和插座• 压入式插座	页 131	附件 <ul style="list-style-type: none">• 索引
页 12	Ø 2 mm系统 <ul style="list-style-type: none">• 综述• 测试导线• 自组装插头和插座• 焊入式/压入式/内置插座• 短接插头• 测试夹• 适配器		
页 37	Ø 4 mm系统 <ul style="list-style-type: none">• 综述• 测试导线• 自组装插头和插座• 焊入式/压入式/内置插座• 短接插头• 测试探头• 测试夹• 适配器• 开尔文测试导线• 特殊测试附件：用于电压高达5kV的绝缘测试设备		

为连接解决方案提供无限可能

MULTILAM 技术



MULTILAM 是经特殊成型的弹性连接元件。所有史陶比尔电连接器产品均受益于 **MULTILAM** 技术独特而出色的性能。

MULTILAM 页片通过恒定的弹簧压力，能够持续保持与连接表面的接触，使接触电阻低且恒定。

MULTILAM 技术能够为有最严苛需求的连接器和要求高达一百万次插拔的特定产品提供解决方案。

这使得 MULTILAM 技术成为满足严苛需求应用的最佳选择：

- 运行可靠长久，源于稳定优越的性能
- 能够在对温度、振动和冲击有严格要求的环境下安全运行
- 特别适合大电流连接器，也适合数据和信号以及高压连接
- 高插拔次数，自动化解决方案



通用信息

长度和颜色

对于可提供多种颜色和导线长度的产品,请在订单号后注明需要的长度和颜色代码,用以替代目录中的空格和*号。

20 黄绿色	26 紫色
21 黑色	27 棕色
22 红色	28 灰色
23 蓝色	29 白色
24 黄色	30 橙色
25 绿色	33 透明

导线长度

该目录中所有标准导线的长度均是电缆的可见长度。

标准件

可提供目录册或颜色/长度组合中列出的颜色,没有最小起订量。

多种选择

• 可选颜色

本目录册除了包含标准颜色,还有其它可选颜色。

在起订量超过100时,可订购这些颜色产品。

• 可选长度

如果您需要非标测试导线,根据产品,可以订购数量从10到100。

关于订购条件可随时联系我们。

特殊件

作为定制化方案解决商,史陶比尔电连接器公司同样提供未列在目录中颜色组合。

我们非常乐意向您提供价格、交期和最小起订量等特殊件信息。

欧洲安全标准

所有产品都符合以下欧盟指令:

- 关于限制在电子电气设备中使用某些有害物质的指令 2011/65/EU (RoHS)。
- 关于协调各成员国在市场上提供在特定电压限制范围内使用的电气生产设备的指令 2014/35/EU (LVD)。

通过遵守以下标准,来符合这些指令:

EN IEC 63000:2018

EN 61010-031:2015

RoHS

European Directive 2011/65/EU incl. all related amendments (e.g. Delegated Directive (EU) 2015/863)

了解更多信息,请访问下面网址。

www.staubli.com/de/en/electrical-connectors/downloads/certificates/material-compliance.html

符号



本产品有配件或特殊工具



使用前请阅读用户信息 i000.



该产品附有安装说明 MA000.



可选颜色

可选长度

表面材料

Au	镀金
Ni	镀镍
Opt	Optalloy®
Ag	镀银
Sn	镀锡
SST	不锈钢
PVC	聚氯乙烯
SIL	硅胶
TPE	磷酸三苯酯

变更/免责条款

本目录中所有数据、插图以及尺寸图都经过仔细的校对,并且与我们的经验一致。但是,我们对其中的错误不承担任何责任。同时我们保留出于产品设计及技术安全原因做出变更的权利,恕不另行通知。因此,当您的设计中集成有我们的零件时,我们建议您不要单纯依赖目录中所给的数据资料,而是和我们联系以确保您掌握最新信息。我们将非常乐意为您提供咨询。

版权

未经我方事先的书面允许,不得以任何形式将样本材料用作他用。

根据IEC/EN 61010-031的测量种类划分

为了便于正确选择测试附件，IEC/EN 61010-031标准建立了多个类定义来定义可以用于供电网络的产品，并制定了每个类别的相应要求。

2002年之前，测量种类由电压类别指定。事实上，这个术语的来源主要基于电网中可能产生的电压(浪涌)的分类。

实际上，在短路状态下，每个测试类别关于有效能的预期瞬态值区别并不大。

相比低级别的测量类别，高级别释放更多能量，结果甚至可能会发生爆炸给用户带来严重后果。

在IEC/EN 61010-031标准中有不同的测量类别，缩写为“CAT”。在本目录册中，可以在额定电压和产品上找到包括后续编号的CAT信息。总的来说，CAT等级越高，就需要更高安全等级的测试附件产品。

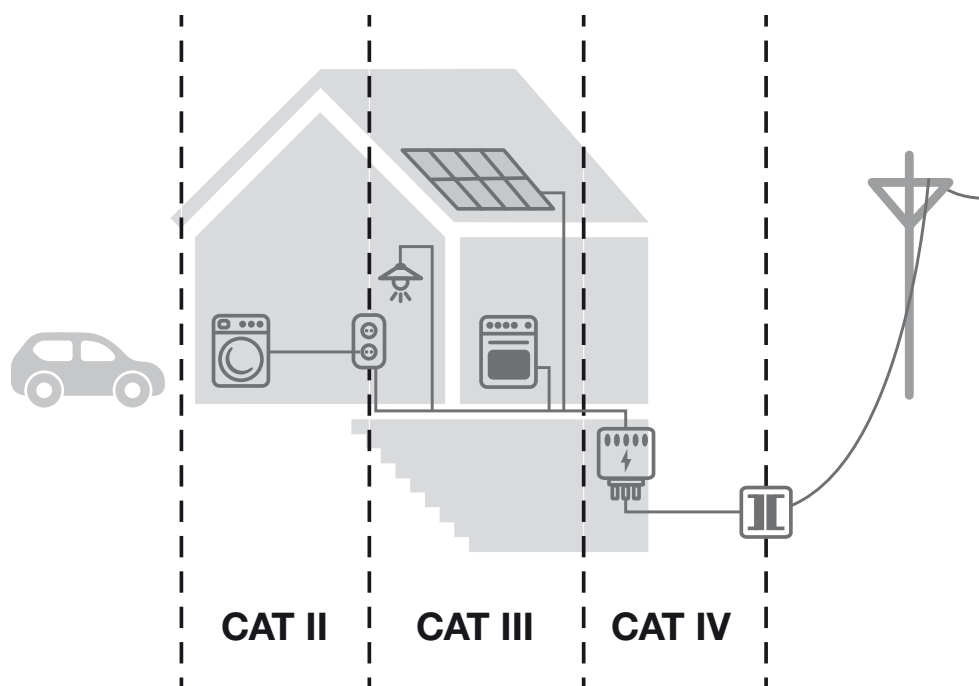



CAT II 应用于测量普通的与电网相连的设备，或由电网供电并不构成电网装置一部分的设备。

CAT III 应用于测量房子的内部走线或者整个建筑物的供电设备。

CAT IV 应用于测量变电站与用电建筑物配电柜之间的输变电路(输入侧)。

Ø 1 MM系统 综述

	AC 30 V/DC 60 V
测试导线 最大 6 A	 页码 9
自组装插头和插座 最大 6 A	 页码 10
压入式插座 最大 20 A	 页码 11

测试导线

测试导线 LK1-A

高柔软测试导线, 两端带堆叠式 Ø1mm 硬质插头。

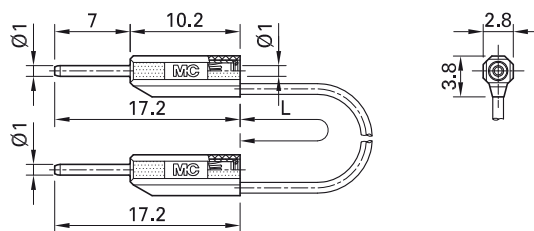
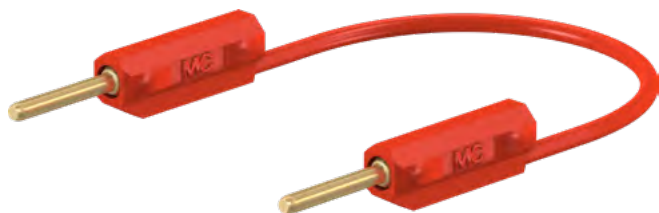

订货号	型号	额定电压/额定电流	导线		导线长度 L [cm]	*标准颜色
28.0026-□*	LK1-A	AC 30 V/3 A DC 60 V/3 A	pvc 0.127mm ²	Au	015 030	21 22



可选颜色 [23](#)

可选长度请洽询

更多信息, 第6页

自组装插头和插座

插头 SLS1-S

Ø 1 mm, 硬质, 用于自组装测试导线。

焊接

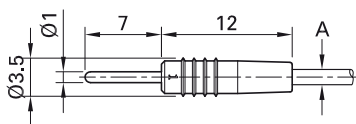

订货号	型号	额定电压/额定电流	导线 (A)			*标准颜色
22.2602-*	SLS1-S	AC 30 V/6 A DC 60 V/6 A	最大 Ø 1.7 mm	0.25 mm ²	Au	21 22 23



安装说明 MA144

www.staubli.com/electrical



可选颜色 24 25 26 27 28 29

更多信息, 第6页

插座 SLS1-B

Ø 1 mm, 采用弹簧MULTILAM技术, 用于自组装测试导线。

焊接

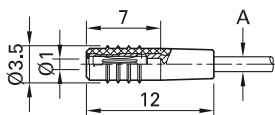

订货号	型号	额定电压/额定电流	导线 (A)			*标准颜色
22.2603-*	SLS1-B	AC 30 V/6 A DC 60 V/6 A	最大 Ø 1.7 mm	0.25 mm ²	Au	21 22 23



安装说明 MA145

www.staubli.com/electrical



可选颜色 24 25 26 27 28 29

更多信息, 第6页

压入式插座

压入式插座 EB1

带绝缘, $\varnothing 1$ mm, 采用 弹簧MULTILAM技术, 黄铜, 插座压入预打孔面板进行安装。

焊接

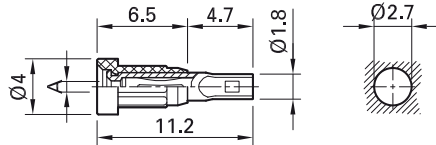

订货号	型号	额定电压/额定电流	插座尺寸 (A)		*标准颜色
23.1010-*	EB1	AC 30 V/20 A DC 60 V/20 A	$\varnothing 1.0$ mm	Au	21 22 23



可选颜色 20 24 25 26 27 28 29

更多信息, 第6页



压入工具 MB1, 第127页



安装说明 MA102

www.staubli.com/electrical

Ø 2 MM系统 综述

测量类别	AC 30 V/DC 60 V	300 V		600 V		1000 V
		CAT II	CAT III	CAT II	CAT III	CAT III
额定电流						
测试导线 最大 10 A	 页码 13 - 14	 页码 14	 页码 15	 页码 14	 页码 15	
自组装插头和插座 最大 10 A	 页码 16 - 17		 页码 18			
焊入式/压入式/内置 插座 最大 15 A	 页码 19 - 26			 页码 27 - 28		
短接插头 最大 10 A	 页码 29 - 31		 页码 32			
测试探头 最大 1 A				 页码 32		
测试夹 最大 10 A	 页码 33	 页码 33		 页码 34		
适配器 最大 10 A	 页码 35 - 36					

测试导线

测试导线 LK205...

高柔软测试导线, 两端带堆叠式 $\varnothing 2$ mm MULTILAM插头。

LK205

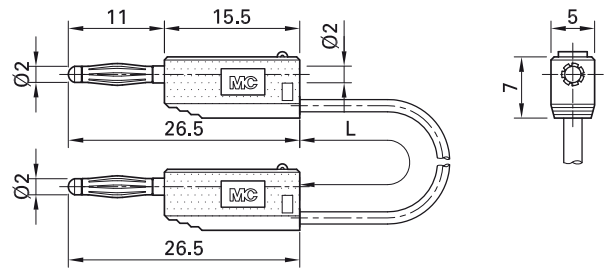

订货号	型号	额定电压/额定电流	导线		导线长度 L [cm]	*标准颜色
28.0115-□*	LK205-X	AC 30 V/10 A DC 60 V/10 A	PVC 0.5 mm ²	Ni	007 (7.5 cm) 015 030 045 060	21 22 23 24 25
28.0039-□*	LK205	AC 30 V/10 A DC 60 V/10 A	PVC 0.5 mm ²	Au	007 (7.5 cm) 015 030 045 060	21 22 23 24 25 27 28 29



用户信息 i093

www.staubli.com/electrical



可选颜色 26 27 28 29

可选长度请咨询
更多信息, 第6页

测试导线 LK2-F

高柔软测试导线, 两端带堆叠式 $\varnothing 2$ mm 空心插头。

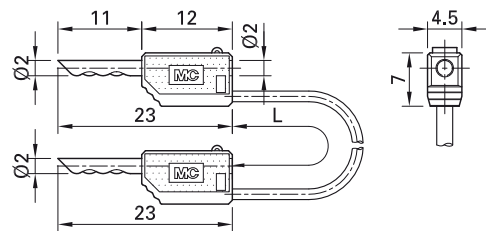

订货号	型号	额定电压/额定电流	导线		导线长度 L [cm]	*标准颜色
28.0033-□*	LK2-F	AC 30 V/10 A DC 60 V/10 A	PVC 0.5 mm ²	Au	015 030 045 060	21 22 23



用户信息 i093

www.staubli.com/electrical



可选颜色 24 25 27 28 29

可选长度请咨询
更多信息, 第6页

测试导线 LK205-L

高柔软测试导线，两端带直插式 Ø 2 mm
MULTILAM直插式插头。

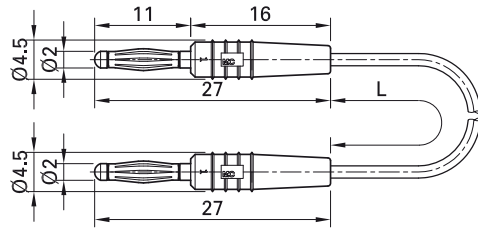

订货号	型号	额定电压/额定电流	导线		导线长度 L [cm]	*标准颜色
28.0047-□*	LK205-L	AC 30 V/10 A DC 60 V/10 A	PVC 0.5 mm ²	Au	007 (7.5 cm) 015 030 045 060	21 22 23 24 25 26 28



用户信息 **i093**

www.staubli.com/electrical



可选颜色 ²⁹

可选长度请咨询
更多信息, 第6页

测试导线 SLK205-K...

PVC绝缘的高柔软测试导线，两端带硬质绝缘
套管的堆叠式 Ø 2 mm MULTILAM插头。

SLK205-K

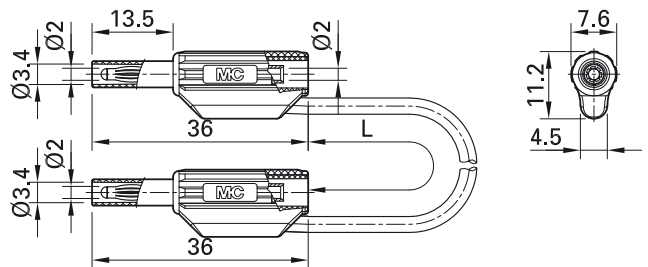

订货号	型号	额定电压/额定电流	导线		导线长度 L [cm]	*标准颜色
65.9179-□*	SLK205-K	600 V, CAT II/10 A	PVC 0.5 mm ²	Au CE UK CA c UL US	030 060 100	21 22 23 24 25



可选颜色 ²⁹

可选长度请咨询
更多信息, 第6页

测试导线 SLK205-W/L...

PVC或硅胶绝缘的高柔软测试导线, 一端带硬绝缘套管的直插式 Ø 2 mm MULTILAM插头, 另一端带硬绝缘套管的直角式 Ø 2 mm MULTILAM插头。

SLK205-W/L

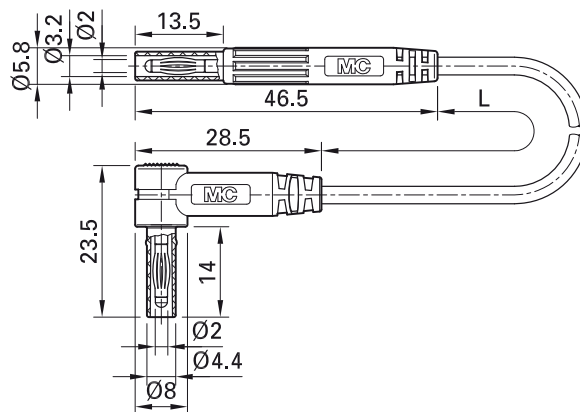

订货号	型号	额定电压/额定电流	导线		导线长度 L [cm]	*标准颜色
65.9577-□*	SLK205-W/L	600 V, CAT III/10 A	PVC 0.5 mm ²	Au CE UK CA	100	21 22
65.9578-□*	SLK205-W/L/SIL	600 V, CAT III/10 A	SIL 0.5 mm ²	Au CE UK CA	100	21 22



可选颜色 [23](#) [24](#) [25](#) [29](#)

可选长度请洽询

更多信息, 第6页

自组装插头和插座

插头 SLS205...

堆叠式, $\varnothing 2$ mm, 采用弹簧MULTILAM技术,
用于自组装测试导线。

焊接

SLS205



SLS205-X

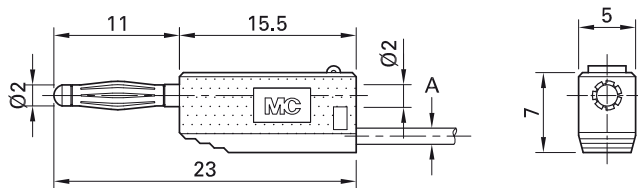
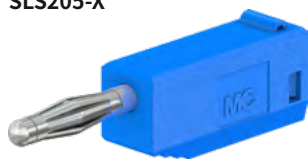

订货号	型号	额定电压/额定电流	导线 (A)		*标准颜色																	
22.2616-*	SLS205	AC 30 V/10 A DC 60 V/10 A	<table border="1"> <tr> <td>PVC</td> <td>TPE</td> <td>$\varnothing 2.1$ mm</td> </tr> <tr> <td>SIL</td> <td></td> <td>$\varnothing 2.3$ mm</td> </tr> </table>	PVC	TPE	$\varnothing 2.1$ mm	SIL		$\varnothing 2.3$ mm	0.5 mm ²	Au	<table border="1"> <tr> <td>21</td> <td>22</td> <td>23</td> <td>24</td> <td>25</td> </tr> <tr> <td>26</td> <td>27</td> <td>28</td> <td>29</td> <td></td> </tr> </table>	21	22	23	24	25	26	27	28	29	
PVC	TPE	$\varnothing 2.1$ mm																				
SIL		$\varnothing 2.3$ mm																				
21	22	23	24	25																		
26	27	28	29																			
22.2617-*	SLS205-X	AC 30 V/10 A DC 60 V/10 A	<table border="1"> <tr> <td>PVC</td> <td>TPE</td> <td>$\varnothing 2.1$ mm</td> </tr> <tr> <td>SIL</td> <td></td> <td>$\varnothing 2.3$ mm</td> </tr> </table>	PVC	TPE	$\varnothing 2.1$ mm	SIL		$\varnothing 2.3$ mm	0.5 mm ²	Ni	<table border="1"> <tr> <td>21</td> <td>22</td> <td>23</td> <td>24</td> <td>25</td> </tr> <tr> <td>26</td> <td>27</td> <td>28</td> <td>29</td> <td></td> </tr> </table>	21	22	23	24	25	26	27	28	29	
PVC	TPE	$\varnothing 2.1$ mm																				
SIL		$\varnothing 2.3$ mm																				
21	22	23	24	25																		
26	27	28	29																			

零件

22.2030-*	KT205	绝缘套
22.1004	LS205	金属件适用于 SLS205
22.5006	LS205N	金属件适用于 SLS205-X



可选颜色 **20**

更多信息, 第6页



安装说明 MA134

www.staubli.com/electrical

插头 SLS2-S

直插式, 硬质, $\varnothing 2$ mm, 用于自组装测试导线。

焊接

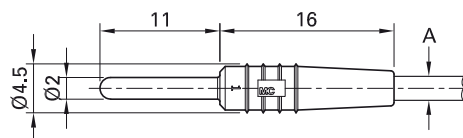

订货号	型号	额定电压/额定电流	导线 (A)		*标准颜色										
22.2609-*	SLS2-S	AC 30 V/10 A DC 60 V/10 A	最大 $\varnothing 2.1$ mm	0.5 mm ²	Au <table border="1"> <tr> <td>21</td> <td>22</td> <td>23</td> <td>24</td> <td>25</td> </tr> <tr> <td>26</td> <td>27</td> <td>28</td> <td>29</td> <td></td> </tr> </table>	21	22	23	24	25	26	27	28	29	
21	22	23	24	25											
26	27	28	29												
零件															
22.2010-*	KT2-S	绝缘套													
22.1002	LS2-S	金属件													



安装说明 MA132

www.staubli.com/electrical

插头 SLS205-L

直插式, $\varnothing 2$ mm, 采用弹簧MULTILAM技术,

用于自组装测试导线。

焊接

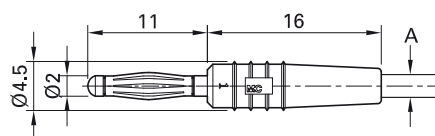

订货号	型号	额定电压/额定电流	导线 (A)		*标准颜色										
22.2618-*	SLS205-L	AC 30 V/10 A DC 60 V/10 A	最大 $\varnothing 2.1$ mm	0.5 mm ²	Au <table border="1"> <tr> <td>21</td> <td>22</td> <td>23</td> <td>24</td> <td>25</td> </tr> <tr> <td>26</td> <td>27</td> <td>28</td> <td>29</td> <td></td> </tr> </table>	21	22	23	24	25	26	27	28	29	
21	22	23	24	25											
26	27	28	29												
零件															
22.2010-*	KT2-S	绝缘套													
22.1009	LS205-L	金属件适用于 SLS205-L													



安装说明 MA136

www.staubli.com/electrical

插头 SL205-K

堆叠式, $\varnothing 2$ mm, 采用弹簧MULTILAM技术,
用于自组装测试导线, 带硬质绝缘外壳。

焊接

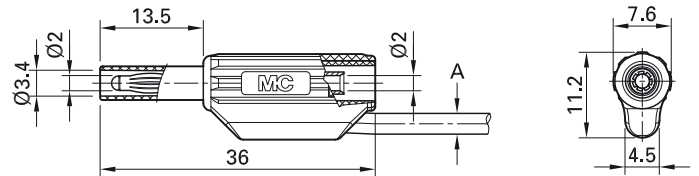

订货号	型号	额定电压/额定电流	导线 (A)		*标准颜色															
65.9182-*	SL205-K	600 V, CAT II/10 A	<table border="1"> <tr> <td>PVC</td> <td>$\varnothing 2.3$ mm</td> <td rowspan="2">0.5 mm²</td> </tr> <tr> <td>SIL</td> <td>$\varnothing 2.7$ mm</td> </tr> </table>	PVC	$\varnothing 2.3$ mm	0.5 mm ²	SIL	$\varnothing 2.7$ mm	Au	<table border="1"> <tr> <td>21</td> <td>22</td> <td>23</td> <td>24</td> <td>25</td> </tr> <tr> <td>29</td> <td></td> <td></td> <td></td> <td></td> </tr> </table>	21	22	23	24	25	29				
PVC	$\varnothing 2.3$ mm	0.5 mm ²																		
SIL	$\varnothing 2.7$ mm																			
21	22	23	24	25																
29																				



安装说明 MAH500

www.staubli.com/electrical

焊入式/压入式/内置插座

压入式插座LB2

无绝缘 $\varnothing 2$ mm硬质插座, 滚压黄铜板。可直接压入或焊接到印刷电路板、电路板或外壳的孔中进行安装。

焊接

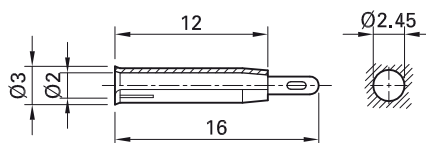

订货号	型号	额定电压/额定电流		
23.1001	LB2	AC 30 V/10 A DC 60 V/10 A	Au	



压入工具 MB2, 第127页

焊入式插座 LB2-A

无绝缘 $\varnothing 2$ mm硬质插座, 黄铜。插座焊入预打孔面板进行安装。

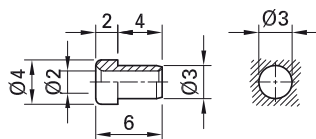

订货号	型号	额定电压/额定电流		
23.1000	LB2-A	AC 30 V/10 A DC 60 V/10 A	Au	

焊入式插座 LB2-D

无绝缘 $\varnothing 2$ mm硬质插座, 黄铜。插座焊入预打孔面板进行安装。

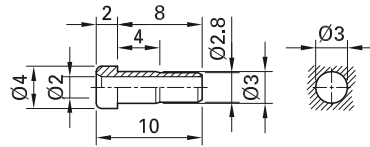

订货号	型号	额定电压/额定电流		
49.7512	LB2-D	AC 30 V/10 A DC 60 V/10 A	Au	

压入式插座 EPB-2N/S

带绝缘 $\varnothing 2$ mm硬质插座, 黄铜。插座压入塑料或金属等材质预打孔面板进行安装。

连接方式: $\varnothing 1.5$ mm 焊针

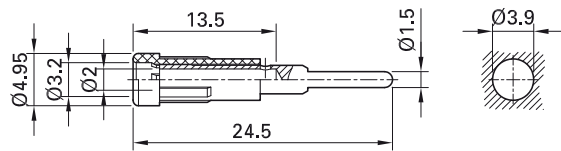

订货号	型号	额定电压/额定电流		*标准颜色										
63.9318-*	EPB-2N/S	AC 30 V/10 A DC 60 V/10 A	Ni	<table border="1"> <tr> <td>21</td> <td>22</td> <td>23</td> <td>24</td> <td>25</td> </tr> <tr> <td>26</td> <td>27</td> <td>29</td> <td></td> <td></td> </tr> </table>	21	22	23	24	25	26	27	29		
21	22	23	24	25										
26	27	29												



压入工具 MB2, 第127页

压入式插座 EB2...

带绝缘 $\varnothing 2$ mm硬质插座, 黄铜。插座压入塑料或金属等材质预打孔面板进行安装。

EB2

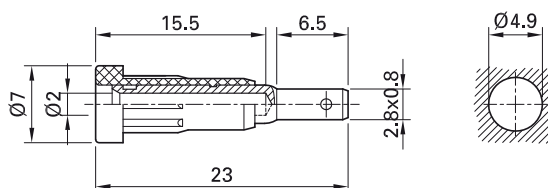

EB2-A

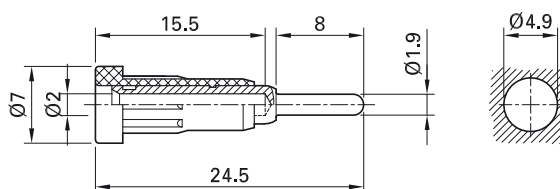

订货号	型号	额定电压/额定电流	连接方式		*标准颜色										
23.1011-*	EB2	AC 30 V/10 A DC 60 V/10 A	扁平连接片 2.8 mm x 0.8 mm	Au	<table border="1"> <tr> <td>20</td><td>21</td><td>22</td><td>23</td><td>24</td> </tr> <tr> <td>25</td><td>26</td><td>27</td><td>28</td><td>29</td> </tr> </table>	20	21	22	23	24	25	26	27	28	29
20	21	22	23	24											
25	26	27	28	29											
23.1012-*	EB2-A	AC 30 V/10 A DC 60 V/10 A	圆形针 $\varnothing 1.9$ mm	Au	<table border="1"> <tr> <td>20</td><td>21</td><td>22</td><td>23</td><td>24</td> </tr> <tr> <td>25</td><td>26</td><td>27</td><td>28</td><td>29</td> </tr> </table>	20	21	22	23	24	25	26	27	28	29
20	21	22	23	24											
25	26	27	28	29											

零件

23.5011-*	I-EB2	绝缘座
23.5010	B-EB2	金属件适用于 EB2
23.5002	B-EB2-A	金属件适用于 EB2-A



压入工具 MB2, 第127页



安装说明 MA102

www.staubli.com/electrical

压入式插座 EB2-F

带绝缘, \varnothing 2 mm, 采用弹簧MULTILAM技术, 黄铜。插座压入塑料或金属等材质预打孔面板进行安装。

连接方式: 扁平连接片 2.8 mm x 0.8 mm

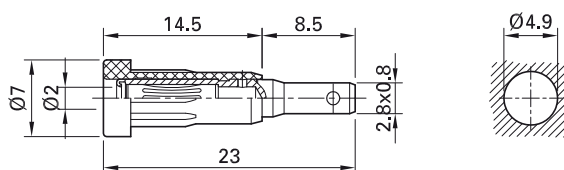

订货号	型号	额定电压/额定电流		*标准颜色
23.1021-*	EB2-F	AC 30 V/10 A DC 60 V/10 A	Opt	21 22

零件

23.5011-*	I-EB2	绝缘座
23.5005	B-EB2-F	金属件



可选颜色 20 23 24 25 26 27 28 29

更多信息, 第6页



压入工具 MB2, 第127页



安装说明 MA102

www.staubli.com/electrical

面板安装插座 LB-I2R

带绝缘 $\varnothing 2$ mm硬质插座, 黄铜。绝缘体带金属
螺纹护套。插座螺纹安装于预打孔面板。
连接方式: 扁平连接片 $2.8\text{ mm} \times 0.8\text{ mm}$

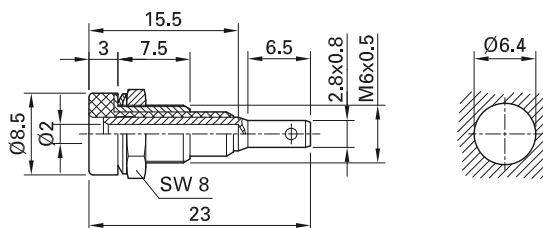

订货号	型号	额定电压/额定电流		*标准颜色										
23.0030-*	LB-I2R	AC 30 V/10 A DC 60 V/10 A	Opt	<table border="1"> <tr> <td>20</td> <td>21</td> <td>22</td> <td>23</td> <td>24</td> </tr> <tr> <td>25</td> <td>26</td> <td>27</td> <td>28</td> <td>29</td> </tr> </table>	20	21	22	23	24	25	26	27	28	29
20	21	22	23	24										
25	26	27	28	29										

面板安装插座 LB2-IF

带绝缘, $\varnothing 2$ mm, 采用弹簧MULTILAM技术,
插座螺纹安装于预打孔面板。
焊接

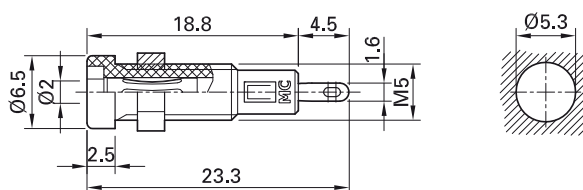

订货号	型号	额定电压/额定电流		*标准颜色					
23.0050-*	LB2-IF	AC 30 V/10 A DC 60 V/10 A	Au	<table border="1"> <tr> <td>21</td> <td>22</td> <td>23</td> <td>24</td> <td>25</td> </tr> </table>	21	22	23	24	25
21	22	23	24	25					

面板安装插座 LB-IF2R

带绝缘, $\varnothing 2$ mm, 采用弹簧MULTILAM技术, 绝缘体带金属螺纹护套。插座螺纹安装于预打孔面板。

连接方式: 扁平连接片 2.8 mm x 0.8 mm

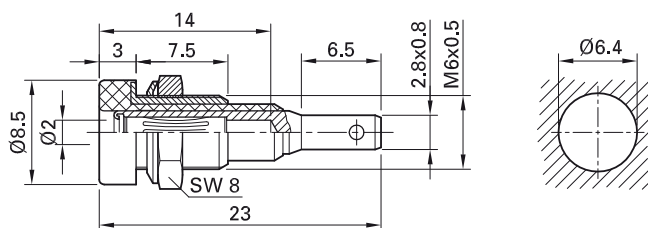

订货号	型号	额定电压/额定电流		*标准颜色										
23.0060-*	LB-IF2R	AC 30 V/10 A DC 60 V/10 A	Opt	<table border="1"> <tr> <td>20</td> <td>21</td> <td>22</td> <td>23</td> <td>24</td> </tr> <tr> <td>25</td> <td>26</td> <td>27</td> <td>28</td> <td>29</td> </tr> </table>	20	21	22	23	24	25	26	27	28	29
20	21	22	23	24										
25	26	27	28	29										

可通过订货号 23.0020-*订购圆形螺母款, 圆形螺母型号为MUR/M6x0,5(管状扳手:SS2)。

端联块BL2-.../20...

端联块, 由两排硬质插座焊接组成, 每排十个。不需要单独安装插座, 只需在面板上简单

钻孔, 用五个螺丝沿焊接方向进行安装。插座间距有6 mm和12 mm两种。

BL2-6/20/A

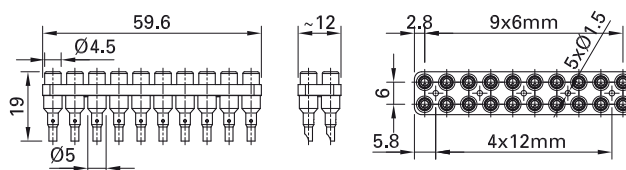
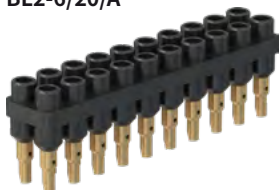

BL2-12/20/A

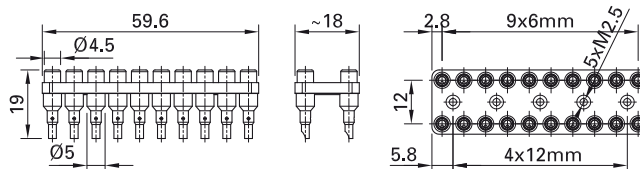
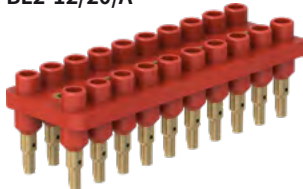

BL2-6/20-0,65

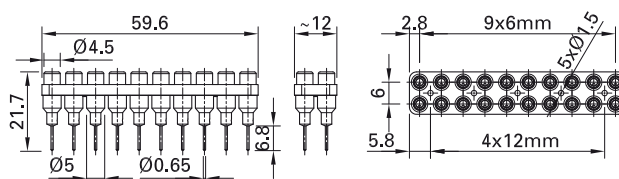
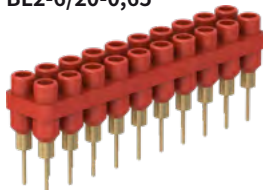

BL2-12/20-0,65

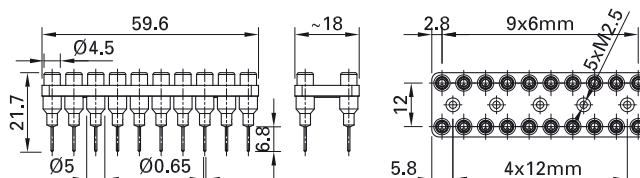

订货号	型号	额定电压/额定电流	插座数量	插头间距	安装说明		*标准颜色
63.9356-*	BL2-6/20/A	AC 30 V/10 A DC 60 V/10 A	2 x 10	6 mm	MAH559A	Au	21 22 23 24 25
63.9358-*	BL2-12/20/A	AC 30 V/10 A DC 60 V/10 A	2 x 10	12 mm	MAH559B	Au	21 22 23 24 25
63.9364-*	BL2-6/20-0,65	AC 30 V/10 A DC 60 V/10 A	2 x 10	6 mm	MAH559D	Au	21 22 24
63.9363-*	BL2-12/20-0,65	AC 30 V/10 A DC 60 V/10 A	2 x 10	12 mm	MAH559C	Au	21 22



安装说明 MAH559A, MAH559B
MAH559D; MAH559C

www.staubli.com/electrical



可选颜色 23 24 25 29

更多信息, 第6页

接线柱 PK2-T

带绝缘,带 \varnothing 2 mm硬质插座,黄铜。绝缘头不可拆卸。带 \varnothing 2 mm十字孔,可与电线快速连接。与抗旋转接线片搭配,安装在厚度为4 mm的前面板上。

连接方式: M3螺栓

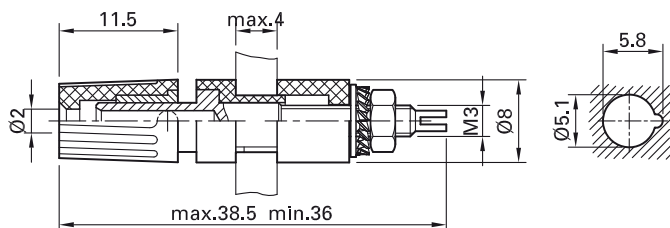

订货号	型号	额定电压/额定电流		*标准颜色
23.0290-*	PK2-T	AC 30 V/15 A DC 60 V/15 A	Ni	21 22

压入式插座 SEB2-...

绝缘硬质插座, 可与带硬质绝缘套管的弹簧式 $\varnothing 2$ mm 插头连接。插座压入塑料或金属等材质预打孔面板进行安装。

连接方式: 扁平连接片 2.8 mm x 0.8 mm 或 圆形针 $\varnothing 1.9$ mm

SEB2-F2,8

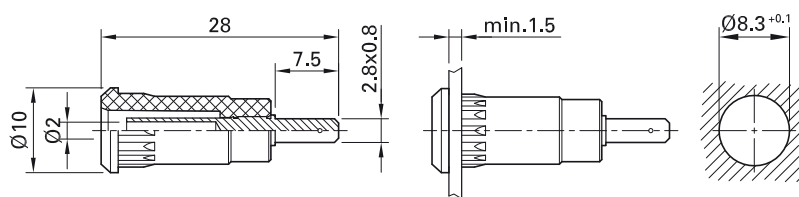

SEB2-R

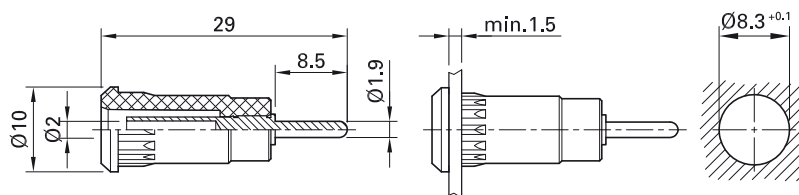

订货号	型号	额定电压/额定电流	连接方式		*标准颜色
65.9099-*	SEB2-F2,8	600 V, CAT III/10 A	扁平连接片 2.8 mm x 0.8 mm	Au	21 22 23 24 25 29
65.9193-*	SEB2-R	600 V, CAT III/10 A	圆形针 $\varnothing 1.9$ mm	Au c RL US	21 22 23 24 25 29



压入工具 MB2-S, 第127页



安装说明 MAH510

www.staubli.com/electrical

面板安装插座 SLB2-...

绝缘硬质插座, 可与带硬质绝缘套管的弹簧式 $\varnothing 2$ mm 插头连接。插座表面安装或沉头安装于塑料或金属等材质预打孔面板。

连接方式: 扁平连接片 $2.8\text{ mm} \times 0.8\text{ mm}$ 或圆形针 $\varnothing 1.9\text{ mm}$

SLB2-F2,8

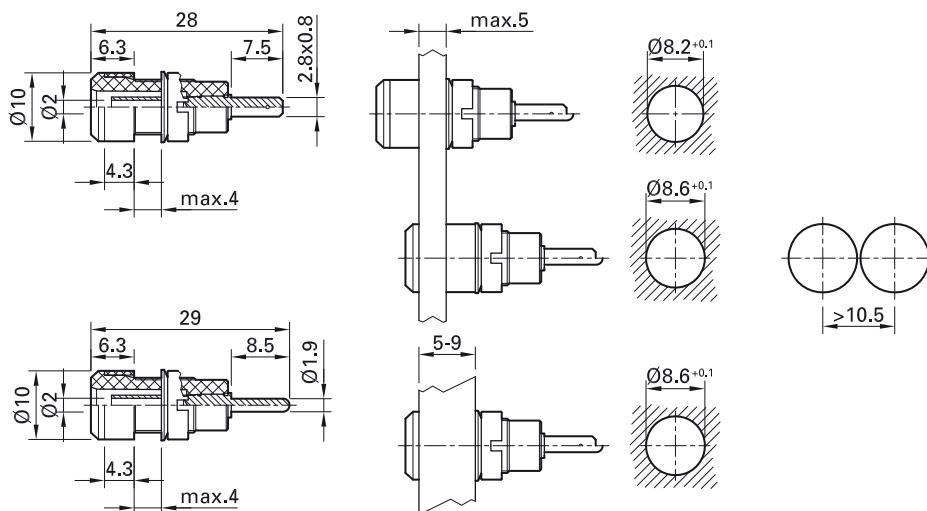
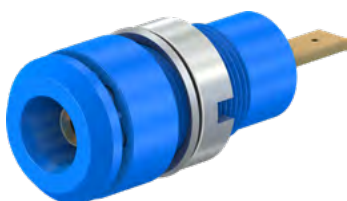

SLB2-R



订货号	型号	额定电压/额定电流	连接方式		*标准颜色
65.9098-*	SLB2-F2,8	600 V, CAT III/10 A	扁平连接片 $2.8\text{ mm} \times 0.8\text{ mm}$	Au	21 22 23 24 25 29
65.9194-*	SLB2-R	600 V, CAT III/10 A	圆形针 $\varnothing 1.9\text{ mm}$	Au  US	21 22 23 24 25 29

可提供的安装材料

-		间隔套 适用于SLB2-F2,8, SLB2-R	
23.5110	MUR/M8x0,5	圆形螺母 适用于SLB2-F2,8, SLB2-R	第123页
23.5107	SP4	垫圈 适用于SLB2-F2,8, SLB2-R	第123页



管状扳手 SS4, SS2-S, 第126页



安装说明 MAH511

www.staubli.com/electrical

短接插头

短接插头 KS2-...

带绝缘, $\varnothing 2$ mm, 手柄内装有 $\varnothing 2$ mm硬质插座。

KS2-6L/A



KS2-6L/N

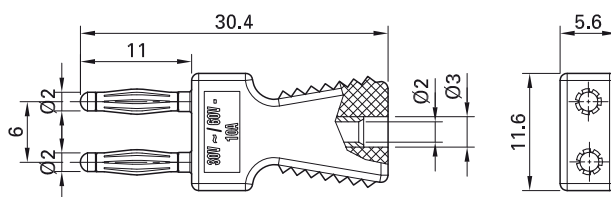
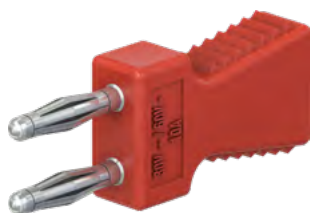

KS2-12L/A

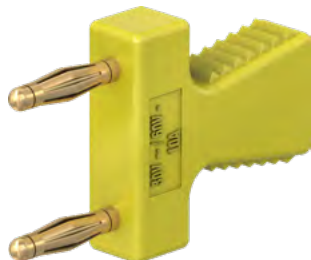

KS2-12L/N

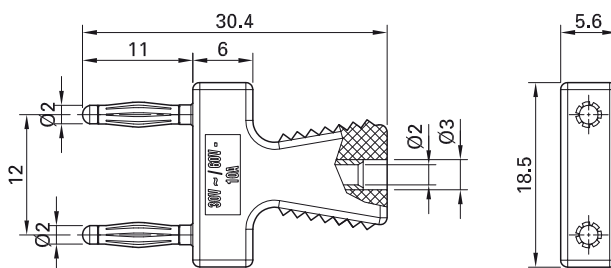

订货号	型号	额定电压/额定电流	插头间距	适用于		*标准颜色
63.9352-*	KS2-6L/A	AC 30 V/10 A DC 60 V/10 A	6 mm	BL2-6/20/A	Au	21 22 23 24 25
63.9353-*	KS2-6L/N	AC 30 V/10 A DC 60 V/10 A	6 mm	BL2-6/20/A	Ni	21 22
63.9354-*	KS2-12L/A	AC 30 V/10 A DC 60 V/10 A	12 mm	BL2-12/20/A	Au	21 22 23 24 25
63.9355-*	KS2-12L/N	AC 30 V/10 A DC 60 V/10 A	12 mm	BL2-12/20/A	Ni	21 22 23 24 25

基于可靠的MULTILAM技术, $\varnothing 2$ mm的短接插头KS2-...L..具有良好的抗振性。与端联块BL2-...25页)配合使用, 将非常适用于航空工业的面板测试和维护。镀金插头具有极低的接触电阻和良好的抗腐蚀性。



可选颜色 23 24 25 28 29

更多信息, 第6页

短接插头 KS2-...

带绝缘, 黄铜, \varnothing 2 mm, 采用弹簧MULTILAM技术, 抗振性能好。适合应用于自动化领域, 如驱动器测试和维修。绝缘体内装有 \varnothing 2 mm

硬质插座, 可与带硬质绝缘套管的弹簧式 \varnothing 2 mm 插头连接。

KS2-5,08L/1A/A

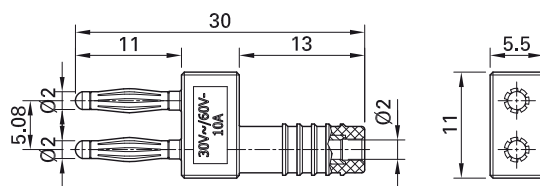

KS2-12L/1SA/N



KS2-12L/1SA/A

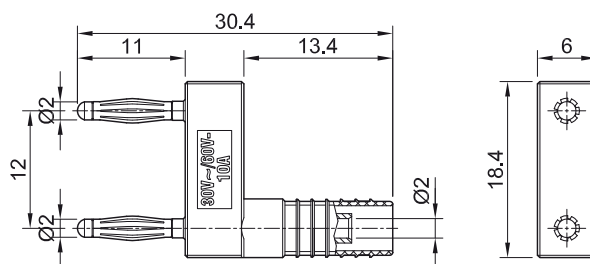

订货号	型号	额定电压/额定电流	插头间距		标准颜色
63.9847-21	KS2-5,08L/1A/A	AC 30 V/10 A DC 60 V/10 A	5.08 mm	Au	21
63.9845-21	KS2-12L/1SA/N	AC 30 V/10 A DC 60 V/10 A	12 mm	Ni	21
63.9848-21	KS2-12L/1SA/A	AC 30 V/10 A DC 60 V/10 A	12 mm	Au	21

短接插头 KS2-10L/1

带绝缘, 黄铜, 由 $\varnothing 2$ mm插头组成的整体件,
采用弹簧MULTILAM技术。

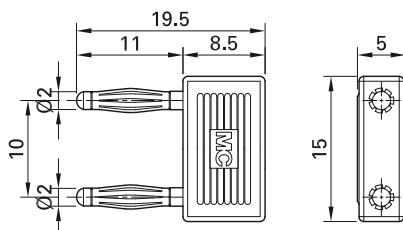

订货号	型号	额定电压/额定电流	插头间距		标准颜色
24.0043-29	KS2-10L/1	AC 30 V/10 A DC 60 V/10 A	10 mm	Au	29

短接插头 KS2-10L

带绝缘, 黄铜, 由 $\varnothing 2$ mm插头组成的整体件,
采用弹簧MULTILAM技术。带绝缘手柄。

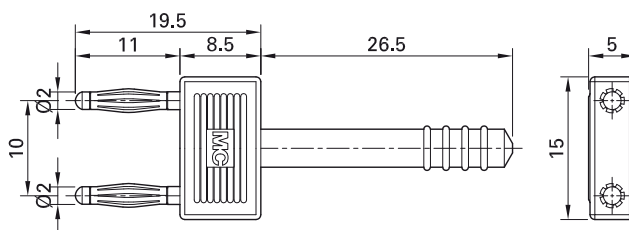



订货号	型号	额定电压/额定电流	插头间距		标准颜色
24.0042-29	KS2-10L	AC 30 V/10 A DC 60 V/10 A	10 mm	Au	29

短接插头 SKS2-12L/1SA/N

带绝缘, 黄铜, 带硬质绝缘套管, 采用弹簧 MULTILAM 技术, 抗振性能好。适合应用于自动化领域, 如驱动器测试和维修。绝缘体内装

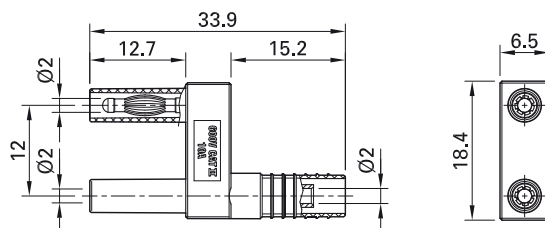
有 $\varnothing 2$ mm 硬质插座, 可与带硬质绝缘套管的弹簧式 $\varnothing 2$ mm 插头连接。



订货号	型号	额定电压/额定电流	插头间距		标准颜色
65.9866-21	SKS2-12L/1SA/N	600 V, CAT II/10 A	12 mm	Ni  UK CA	21

测试探头

测试探头 SPP2-S

带锥形不锈钢硬针头, 手柄两端进行倒角处理 把手处的 $\varnothing 2$ mm 硬质插座, 可与带硬质绝缘套管的弹簧式 $\varnothing 2$ mm 插头连接。配有保护帽。

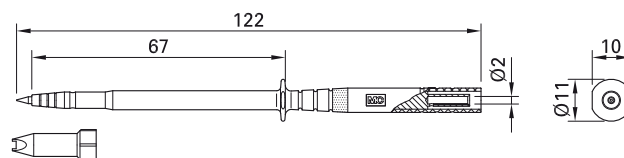

订货号	型号	额定电压/额定电流		*标准颜色
24.0239-*	SPP2-S	1000 V, CAT III/1 A		21 22

测试夹

测试夹 KPS1/B2

抓钩由冷拉铜合金制成, 可用于连接IC引脚, 插针或者裸线。利用弹簧压力将被测对象固定在绝缘体的尖端。由于夹子非常轻, 测试时

不会把重量加在某些关键的连接上。绝缘体内含 $\varnothing 2$ mm硬质插座。

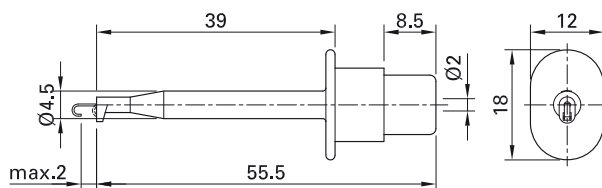

订货号	型号	额定电压/额定电流	压接限制		*标准颜色
24.0139-*	KPS1/B2	AC 30 V/1 A DC 60 V/1 A	最大 2 mm	Au	21 22

测试夹 MicroGrip-XB

带接触区域镀金的硬弹簧钢丝夹。把手处的 $\varnothing 2$ mm 硬质插座, 可与带硬质绝缘套管的弹簧式 $\varnothing 2$ mm 插头连接。

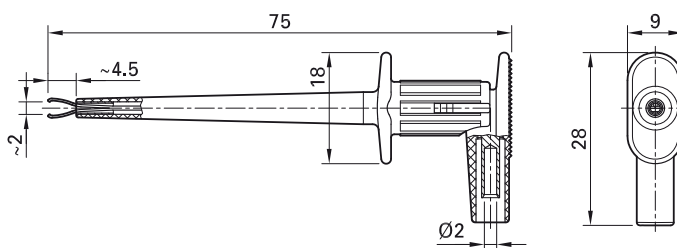

订货号	型号	额定电压/额定电流		*标准颜色
65.9187-*	MicroGrip-XB	300 V, CAT II/1 A	Au CE UK CA c UL US	21 22 23

测试夹 XKK-200

带通体绝缘保护的鳄鱼夹, 黄铜。锯齿状下颌可以夹取细电线。绝缘体内装有 $\varnothing 2$ mm 硬质

插座, 可与带硬质绝缘套管的弹簧式 $\varnothing 2$ mm 插头连接。

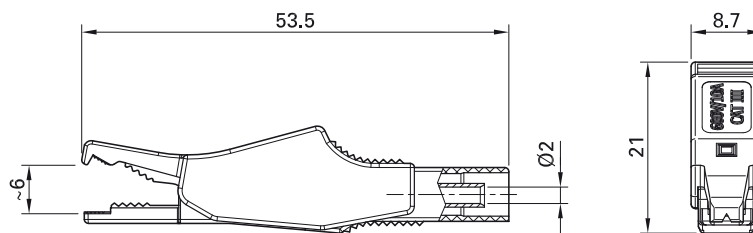

订货号	型号	额定电压/额定电流		*标准颜色
65.9188-*	XKK-200	600 V, CAT III/10 A	Ni CE UK CA c UL US	21 22 23

测试夹导线 XALF

高柔软测试夹导线, 一端带通体绝缘的测试夹, 锯齿状下颌可以夹取细电线。另一端为带硬质绝缘套管的 $\varnothing 2$ mm MULTILAM 插头。

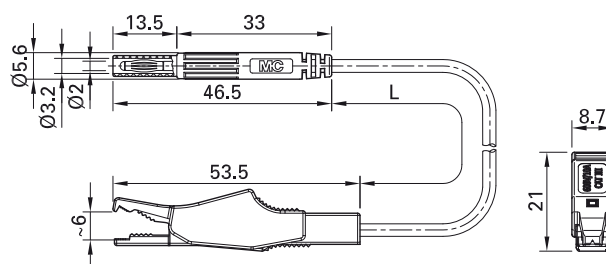

订货号	型号	额定电压/额定电流	导线		导线长度 L [cm]	*标准颜色
65.9185- □*	XALF	600 V, CAT III/10 A	PVC 0.5 mm ²	Ni CE UK CA c UL US	100	21 22 23



可选长度请咨询
更多信息, 第6页

适配器

适配器 A2/4

Ø 2 mm, 黄铜, 采用弹簧MULTILAM技术。绝缘体内装有 Ø 4 mm 硬质插座, 可与带硬质绝缘套管的弹簧式 Ø 4 mm 插头连接。

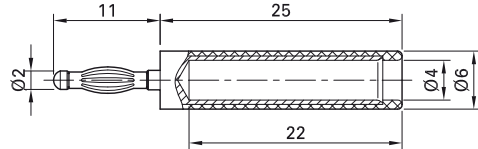

订货号	型号	额定电压/额定电流		*标准颜色
24.0115-*	A2/4	AC 30 V/10 A DC 60 V/10 A	Au	21 22 23 24



用户信息 i093

www.staubli.com/electrical

适配器导线 LK-4A2A-F05

高柔软适配器导线, 一端带堆叠式 Ø 2 mm 硬质插头, 另一端带堆叠式 Ø 4 mm 硬质插头。两端均采用MULTILAM技术。

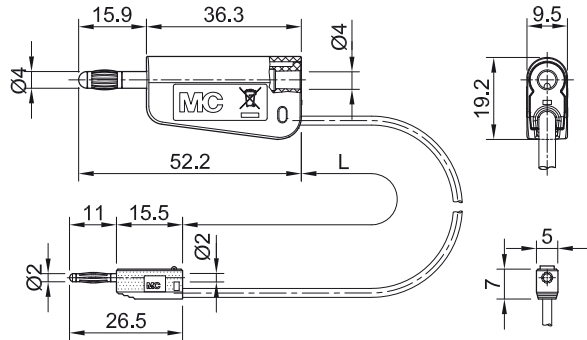

订货号	型号	额定电压/额定电流	导线		导线长度 L [cm]	*标准颜色
64.1060-□*	LK-4A2A-F05	AC 30 V/10 A DC 60 V/10 A	PVC 0.5mm ²	Au	007 (7.5 cm) 015 030 045 060	20 21 22 23 24 25 26 27 28 29



用户信息 i093

www.staubli.com/electrical



可选长度请咨询
更多信息, 第6页

适配器导线 AF-4A2A-F05

高柔软适配器导线，一端带堆叠式 Ø2mmMULTILAM插头；另一端是带硬质绝缘套管的 Ø 4 mm 硬质插座。

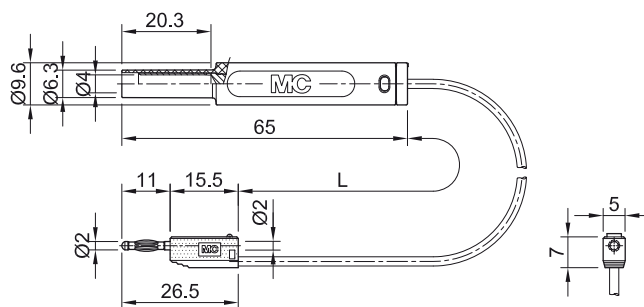

订货号	型号	额定电压	导线		导线长度 L [cm]	*标准颜色
64.1073-□□*	AF-4A2A-F05	AC 30 V/10 A DC 60 V/10 A	PVC 0.5mm ²	Au	015	21 22



可选长度请咨询
更多信息, 第 6 页



用户信息 **i093**

www.staubli.com/electrical

Ø 4 MM系统 综述

	AC 30 V/DC 60 V	300 V		600 V		1000 V			
		CAT II	CAT III	CAT II	CAT III	CAT II	CAT III	CAT IV	
测试导线 最大 32 A	 页码 38 - 40	 页码 41 - 42		 页码 43 - 44		 页码 47		 页码 45, 46, 48	
自组装插头和插座 最大 32 A	 页码 49 - 56	 页码 57	 页码 58 - 60		 页码 61 - 65				
焊入式/压入式/内 置插座 最大 35 A	 页码 49 - 56	 页码 58 - 60				 页码 61 - 65			
短接插头 最大 32 A	 页码 88 - 90		 页码 91						
测试探头 最大 32 A	 页码 92 - 93						 页码 94	 页码 94	
测试夹 最大 32 A	 页码 95	 页码 95	 页码 96		 页码 97 - 98		 页码 98 - 100	 页码 101	
适配器 最大 32 A	 页码 103 - 106	 页码 106 - 109			 页码 110 - 117		 页码 118		
开尔文测试导线 最大 32 A	 页码 119								
特殊测试附件(高达 5kV) 最大 10 A	 页码 120								

测试导线

测试导线 LK-4...

高柔软测试导线, 带堆叠式Ø4 mm MULTILAM 插头。

LK-4A...

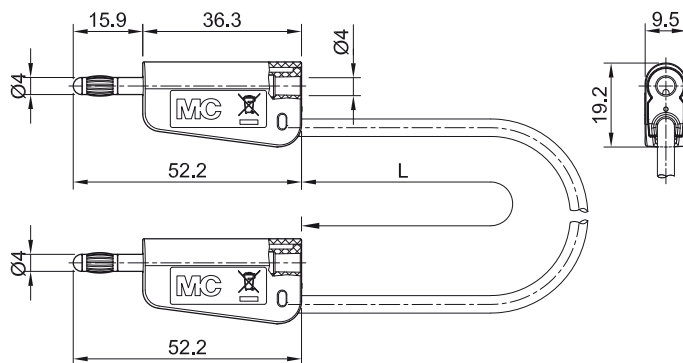

订货号	型号	额定电压/额定电流	导线		导线长度 L [cm]	*标准颜色
64.1032-□*	LK-4N-S10	AC 30 V/19 A DC 60 V/19 A	SIL 1.0 mm ²	Ni	025 050 075 100	20 21 22 23 24
64.1033-□*	LK-4A-S10			Au	150 200	25 26 27 28 29
64.1036-□*	LK-4N-S25	AC 30 V/32 A DC 60 V/32 A	SIL 2.5 mm ²	Ni	025 050 075 100	20 21 22 23 24
64.1037-□*	LK-4A-S25			Au	150 200	25 26 27 28 29
64.1030-□*	LK-4N-F10	AC 30 V/19 A DC 60 V/19 A	PVC 1.0 mm ²	Ni	025 050 075 100	20 21 22 23 24
64.1031-□*	LK-4A-F10			Au	150 200	25 26 27 28 29
64.1034-□*	LK-4N-F25	AC 30 V/32 A DC 60 V/32 A	PVC 2.5 mm ²	Ni	025 050 075 100	20 21 22 23 24
64.1035-□*	LK-4A-F25			Au	150 200	25 26 27 28 29



用户信息 i096, i099

www.staubli.com/electrical

测试导线 AK-4...-F10

高柔软测试导线, 两端带直插式 $\varnothing 4 \text{ mm}$ MULTILAM 插头。

AK-4N-F10



AK-4A-F10

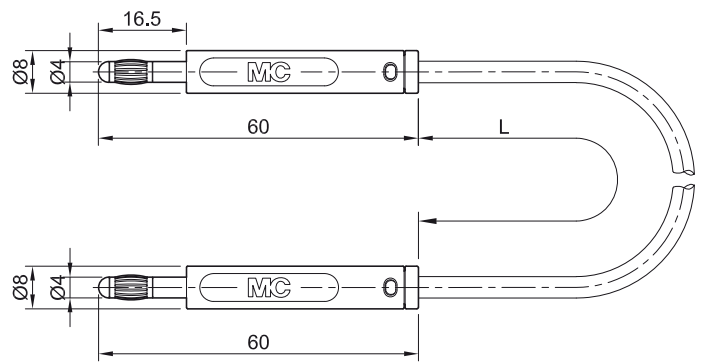

订货号	型号	额定电压/额定电流	导线		导线长度 L [cm]	*标准颜色
64.1070-□*	AK-4N-F10	AC 30 V/19 A DC 60 V/19 A	PVC 1.0 mm ²	Ni	050 100 200	21 22
64.1071-□*	AK-4A-F10	AC 30 V/19 A DC 60 V/19 A	PVC 1.0 mm ²	Au	050 100 200	21 22



可选颜色 20 23 24 25 26 27 28 29

可选长度请洽询

更多信息, 第 6页



用户信息 i096

www.staubli.com/electrical

耦合导线 AB-4A-F10

高柔软耦合导线, 两端均带 $\varnothing 4$ mm硬质插座。

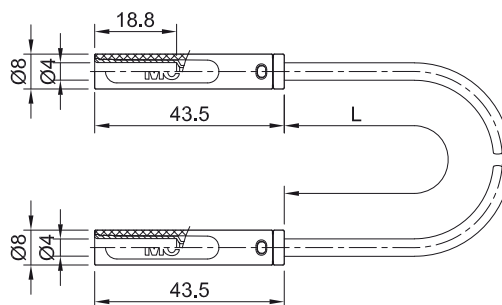

订货号	型号	额定电压/额定电流	导线		导线长度 L [cm]	*标准颜色
64.1072-□□*	AB-4A-F10	AC 30 V/19 A DC 60 V/19 A	PVC 1.0 mm ²	Au	100	21 22



可选颜色 20 23 24 25 26 27 28 29

可选长度请洽询

更多信息, 第 6 页



用户信息 i096

www.staubli.com/electrical

测试导线 XZG4...

高柔软测试导线，两端带有堆叠式 Ø 4 mm MULTILAM插头，带防护颈圈和伸缩套管，可防止意外触摸，尤其适用于不带安全插座的电气设备。

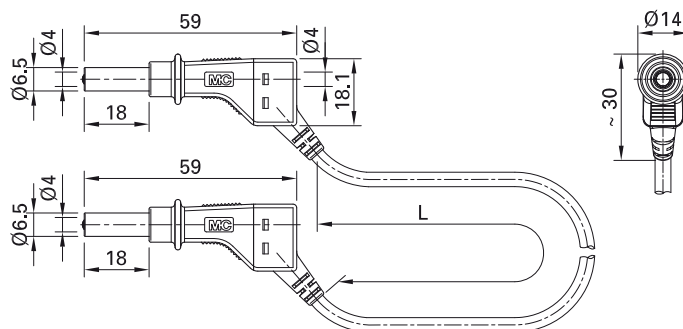

订货号	型号	额定电压/额定电流	导线		导线长度 L [cm]	*标准颜色
66.9405-□*	XZG410	600 V, CAT II/19 A	PVC 1.0 mm ²	Ni CE UK DK	050 100 150 200	21 22 23
66.9406-□*	XZG410/SIL	600 V, CAT II/19 A	SIL 1.0 mm ²	Ni CE UK DK	050 100 150 200	21 22 23
66.9407-□*	XZG425	600 V, CAT II/32 A	PVC 2.5 mm ²	Ni CE UK DK	025 050 100 150 200	21 22 23 24 25 27 28
66.9408-□*	XZG425/SIL	600 V, CAT II/32 A	SIL 2.5 mm ²	Ni CE UK DK	050 100 150 200	20 21 22 23 24 25 26 27 28



可选颜色 20 24 25 26 27 28 29

可选长度请洽询

更多信息, 第6页



用户信息 i073, i074

www.staubli.com/electrical

测试导线 SASK-4N-F10

高柔软测试导线，一端为堆叠式 $\varnothing 4$ mm MULTILAM插头，有防护颈圈和伸缩套管可防止意外触摸，适合与不带安全插座的电气

设备连接。另一端带硬质绝缘套管的直插式 $\varnothing 4$ mm MULTILAM插头，用于连接探针或测试夹。

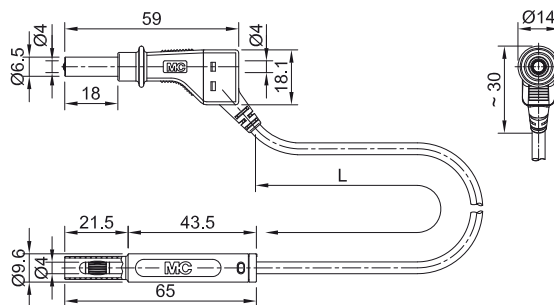

订货号	型号	额定电压/额定电流	导线		导线长度 L [cm]	*标准颜色
66.1048-□□*	SASK-4N-F10	600 V, CAT II/19 A	PVC 1.0 mm ²	Ni CE UK CA	100 200	21 22 23



可选颜色 20 24 25 26 27 28 29

可选长度请洽询

更多信息，第 6 页



用户信息 i073

www.staubli.com/electrical

测试导线 SLK-4...

高柔软测试导线, 两端为带硬质绝缘套管的堆叠式 Ø 4 mm MULTILAM 插头。

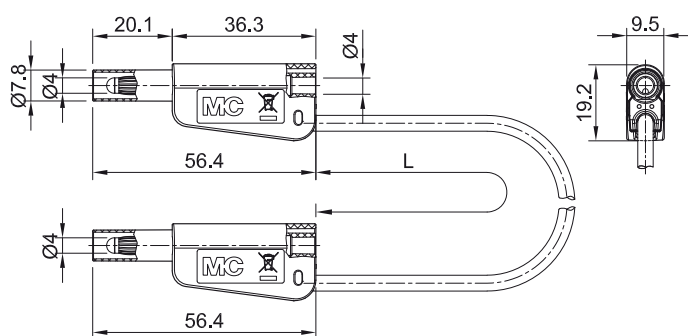

订货号	型号	额定电压/额定电流	导线		导线长度 L [cm]	*标准颜色															
66.2012-□*	SLK-4N-S10	1000 V, CAT II/19 A 600 V, CAT III/19 A	SIL 1.0mm ²	Ni	025 050 075 100 150 200	<table border="1"> <tr><td>20</td><td>21</td><td>22</td><td>23</td><td>24</td></tr> <tr><td>25</td><td>26</td><td>27</td><td>28</td><td>29</td></tr> <tr><td>30</td><td></td><td></td><td></td><td></td></tr> </table>	20	21	22	23	24	25	26	27	28	29	30				
20	21			22			23	24													
25	26	27	28	29																	
30																					
66.2013-□*	SLK-4A-S10	Au																			
66.2016-□*	SLK-4N-S25	1000 V, CAT II/32 A 600 V, CAT III/32 A	SIL 2.5mm ²	Ni	025 050 075 100 150 200	<table border="1"> <tr><td>20</td><td>21</td><td>22</td><td>23</td><td>24</td></tr> <tr><td>25</td><td>26</td><td>27</td><td>28</td><td>29</td></tr> <tr><td>30</td><td></td><td></td><td></td><td></td></tr> </table>	20	21	22	23	24	25	26	27	28	29	30				
20	21			22			23	24													
25	26	27	28	29																	
30																					
66.2017-□*	SLK-4A-S25	Au																			
66.2010-□*	SLK-4N-F10	1000 V, CAT II/19 A 600 V, CAT III/19 A	PVC 1.0mm ²	Ni	025 050 075 100 150 200	<table border="1"> <tr><td>20</td><td>21</td><td>22</td><td>23</td><td>24</td></tr> <tr><td>25</td><td>26</td><td>27</td><td>28</td><td>29</td></tr> <tr><td>30</td><td></td><td></td><td></td><td></td></tr> </table>	20	21	22	23	24	25	26	27	28	29	30				
20	21			22			23	24													
25	26	27	28	29																	
30																					
66.2011-□*	SLK-4A-F10	Au																			
66.2014-□*	SLK-4N-F25	1000 V, CAT II/32 A 600 V, CAT III/32 A	PVC 2.5mm ²	Ni	025 050 075 100 150 200	<table border="1"> <tr><td>20</td><td>21</td><td>22</td><td>23</td><td>24</td></tr> <tr><td>25</td><td>26</td><td>27</td><td>28</td><td>29</td></tr> <tr><td>30</td><td></td><td></td><td></td><td></td></tr> </table>	20	21	22	23	24	25	26	27	28	29	30				
20	21			22			23	24													
25	26	27	28	29																	
30																					
66.2015-□*	SLK-4A-F25	Au																			

测试导线 SAK-4...-F...-TW

高柔软测试导线，两端为带硬质绝缘套管的直插式Ø 4 mm MULTILAM 插头，插头套管极为纤细。

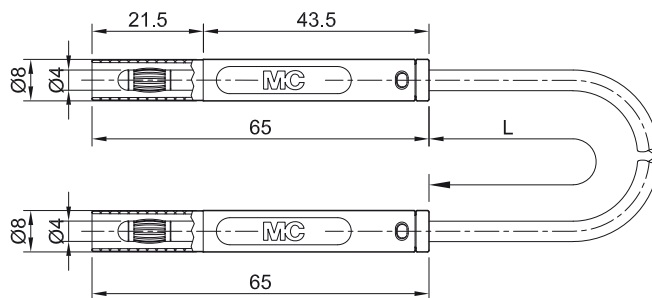

订货号	型号	额定电压/额定电流	导线		用户信息	导线长度 L [cm]	*标准颜色
66.1053-□*	SAK-4N-F10-TW	1000 V, CAT II/19 A	PVC 1.0mm ²	Ni UK CA c UL US	i145	050 100 150 200	21 22 23 24 25
66.1054-□*	SAK-4A-F10-TW	1000 V, CAT II/19 A	PVC 1.0mm ²	Au UK CA c UL US	i145	050 100 150 200	21 22 23 24 25
66.1055-□*	SAK-4N-F25-TW	1000 V, CAT II/32 A	PVC 2.5mm ²	Ni UK CA c UL US	i144	050 100 150 200	21 22 23 24 25
66.1056-□*	SAK-4A-F25-TW	1000 V, CAT II/32 A	PVC 2.5mm ²	Au UK CA c UL US	i144	050 100 150 200	21 22 23 24 25



可选颜色 20 26 27 29

可选长度请洽询

更多信息, 第 6 页



用户信息 i144, i145

www.staubli.com/electrical

测试导线 SAK-4N-...

高柔软测试导线, 两端为带硬质绝缘套管的直插式 Ø 4 mm MULTILAM 插头。

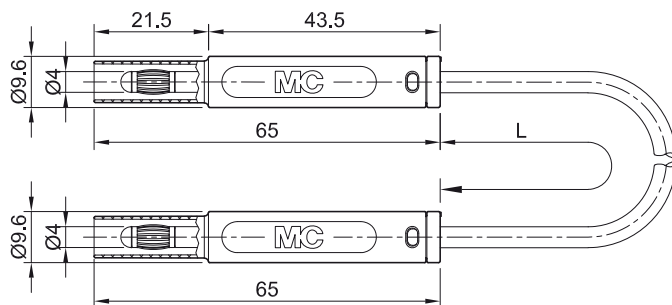

订货号	型号	额定电压/额定电流	导线		用户信息	导线长度 L [cm]	*标准颜色
66.1040-□*	SAK-4N-F10	1000 V, CAT IV/19 A	PVC 1.0mm ²	Ni CE UK PA c UL US	i145	050 100 150 200	21 22 23 24 25 30
66.1041-□*	SAK-4N-S10	1000 V, CAT IV/19 A	SIL 1.0mm ²	Ni CE UK PA c UL US	i145	050 100 150 200	21 22 23 24 25 30
66.1042-□*	SAK-4N-F25	1000 V, CAT IV/32 A	PVC 2.5mm ²	Ni CE UK PA c UL US	i144	050 100 150 200	21 22 23 24 25 27 28 30
66.1043-□*	SAK-4N-S25	1000 V, CAT IV/32 A	SIL 2.5mm ²	Ni CE UK PA c UL US	i144	050 100 150 200	21 22 23 24 25 27 28 30



可选颜色 27 29

可选长度请洽询

更多信息, 第 6 页



用户信息 i144, i145

www.staubli.com/electrical

延长导线 SAF-4N-...10

高柔软测试导线，一端为带硬质绝缘套管的
Ø 4 mm MULTILAM插头。另一端为带硬质绝
缘套管的Ø 4 mm硬质插座。

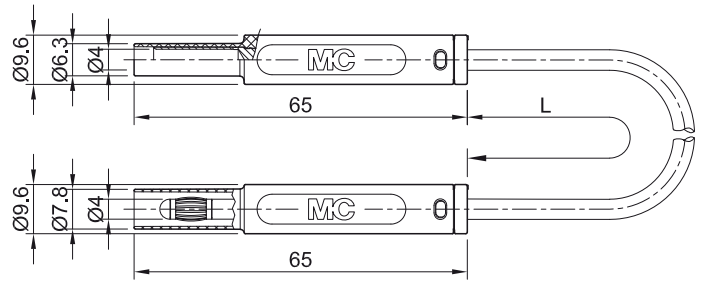

订货号	型号	额定电压/额定电流	导线		导线长度 L [cm]	*标准颜色
66.1044-□*	SAF-4N-F10	1000 V, CAT IV/19 A	PVC 1.0 mm ²	Ni CE UK CA c UL US	050 100 150 200	21 22 23 24
66.1045-□*	SAF-4N-S10	1000 V, CAT IV/19 A	SIL 1.0 mm ²	Ni CE UK CA c UL US	050 100 150 200	21 22 23 24



可选颜色 25 29

可选长度请洽询
更多信息, 第 6页



用户信息 i145

www.staubli.com/electrical

测试导线 SARK-4N-...10

高柔软测试导线，一端为带硬质绝缘套管的直插式 Ø 4 mm MULTILAM 插头；另一端为带

硬质绝缘套管的直角式 Ø 4 mm MULTILAM 插头。

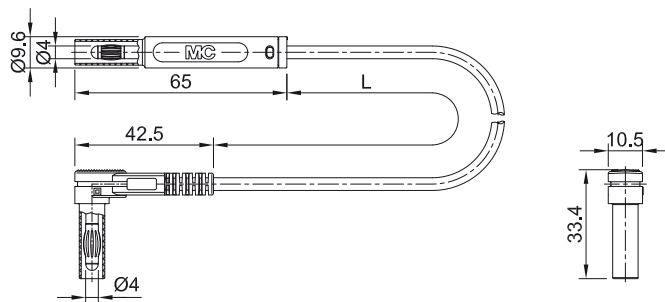

订货号	型号	额定电压/额定电流	导线		导线长度 L [cm]	*标准颜色
66.1049-□*	SARK-4N-F10	1000 V, CAT III/19 A 600 V, CAT IV/19 A	PVC 1.0 mm ²	Ni CE UK CA c UL US	100 150 200	21 22 23 24 25
66.1050-□*	SARK-4N-S10	1000 V, CAT III/19 A 600 V, CAT IV/19 A	SIL 1.0 mm ²	Ni CE UK CA c UL US	100 150 200	21 22 23 24 25



可选颜色 20 26 27 29

可选长度请洽询

更多信息, 第 6 页



用户信息 i141

www.staubli.com/electrical

带保险丝测试导线 SAK-4N-...10-ILF

测试导线带有高熔断保险丝, 专为1000 V CAT IV 应用设计, 符合IEC/EN 61010-031 标准。可以使用Ø 4 mm标准安全探针和测试夹进行带熔断保护的测量。装有保险丝的二段式接头可以扭开, 易于进行保险丝更换。

高柔软测试导线, 两端为带硬质绝缘套管的直插式 Ø 4 mm MULTILAM插头技术。二段式螺纹接头可以安装尺寸为6.3 x 32 mm的高熔断保险丝。
保险丝需另购。

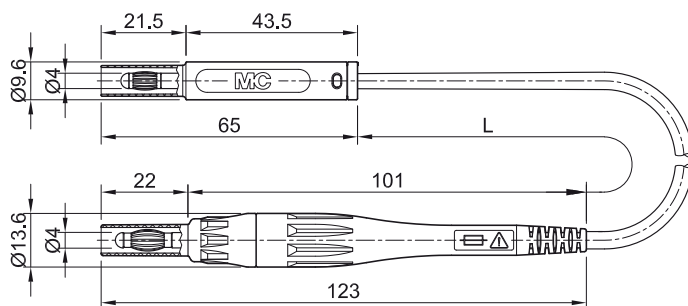
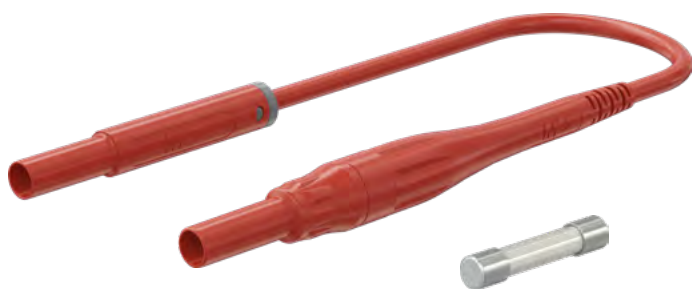

订货号	型号	额定电压/额定电流	导线		导线长度 L [cm]	*标准颜色
66.1046-□□*	SAK-4N-F10-ILF	1000 V, CAT IV/max. 8 A ¹⁾	PVC 1.0mm ²	Ni CE UK CA c UL US	100 150 200	21 22 23 24 25
66.1047-□□*	SAK-4N-S10-ILF	1000 V, CAT IV/max. 8 A ¹⁾	SIL 1.0mm ²	Ni CE UK CA c UL US	100 150 200	21 22 23 24 25

¹⁾ 取决于使用的保险丝。



可选颜色 26 27 28

可选长度请洽询

更多信息, 第 6页



高熔断保险丝 6.3 x 32 mm, 第 128页



用户信息 i142

www.staubli.com/electrical

自组装插头和插座

LQ-4... LM-4...

堆叠式, Ø 4 mm, 采用弹簧MULTILAM技术, 用于自组装测试导线。

多种连接方式:

LM-4...: 螺纹连接

LQ-4...: 十字孔焊接

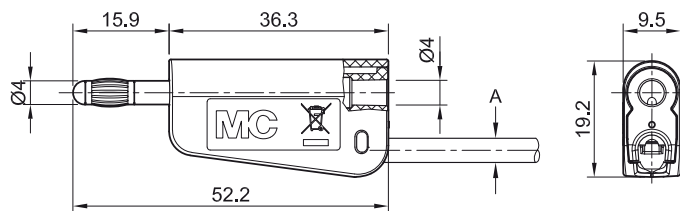

订货号	型号	额定电压/额定电流	导线 (A)		*标准颜色															
64.1038-*	LQ-4N-30	AC 30 V/19 A DC 60 V/19 A	<table border="1"> <tr> <td>PVC</td> <td>Ø 2.7 mm</td> <td rowspan="2">1.0 mm²</td> </tr> <tr> <td>SIL</td> <td>Ø 3.0 mm</td> </tr> </table>	PVC	Ø 2.7 mm	1.0 mm ²	SIL	Ø 3.0 mm	Ni	<table border="1"> <tr> <td>20</td><td>21</td><td>22</td><td>23</td><td>24</td> </tr> <tr> <td>25</td><td>26</td><td>27</td><td>28</td><td>29</td> </tr> </table>	20	21	22	23	24	25	26	27	28	29
PVC	Ø 2.7 mm			1.0 mm ²																
SIL	Ø 3.0 mm																			
20	21			22	23	24														
25	26	27	28	29																
64.1039-*	LQ-4A-30	Au																		
64.1040-*	LM-4N-30	Ni																		
64.1041-*	LM-4A-30	Au																		
64.1042-*	LQ-4N-39	AC 30 V/32 A DC 60 V/32 A	<table border="1"> <tr> <td>PVC</td> <td>Ø 3.6 mm</td> <td rowspan="2">2.5 mm²</td> </tr> <tr> <td>SIL</td> <td>Ø 3.9 mm</td> </tr> </table>	PVC	Ø 3.6 mm	2.5 mm ²	SIL	Ø 3.9 mm	Ni	<table border="1"> <tr> <td>20</td><td>21</td><td>22</td><td>23</td><td>24</td> </tr> <tr> <td>25</td><td>26</td><td>27</td><td>28</td><td>29</td> </tr> </table>	20	21	22	23	24	25	26	27	28	29
PVC	Ø 3.6 mm			2.5 mm ²																
SIL	Ø 3.9 mm																			
20	21			22	23	24														
25	26	27	28	29																
64.1043-*	LQ-4A-39	Au																		
64.1044-*	LM-4N-39	Ni																		
64.1045-*	LM-4A-39	Au																		

零件

64.1046-*	KT-L-4-30	绝缘套适用于	LQ-4N-30; LQ-4A-30; LM-4N-30; LM-4A-30
64.1047-*	KT-L-4-39	绝缘套适用于	LQ-4N-39; LQ-4A-39; LM-4N-39; LM-4A-39
66.2028	LS-SLQ-4N	金属件适用于	LQ-4N-30; LQ-4N-39
66.2029	LS-SLQ-4A	金属件适用于	LQ-4A-30; LQ-4A-39
66.2030	LS-SLM-4N	金属件适用于	LM-4N-30; LM-4N-39
66.2031	LS-SLM-4A	金属件适用于	LM-4A-30; LM-4A-39



安装说明MA167

www.staubli.com/electrical

插头 ZGL-425

堆叠式, \varnothing 4 mm, 采用弹簧MULTILAM技术, 用于自组装测试导线。带伸缩套管可防止意外触摸。

螺纹连接

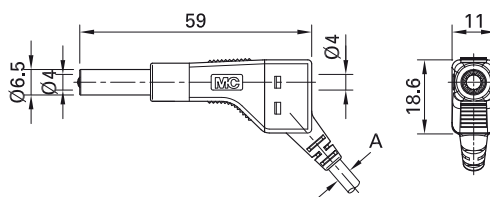

订货号	型号	额定电压/额定电流	导线 (A)		*标准颜色												
64.9326-*	ZGL-425	AC 30 V/32 A DC 60 V/32 A	最小 \varnothing 3,4 mm 最大 \varnothing 3,9 mm	1.0 mm ² ... 2.5 mm ²	<table border="1"> <tr> <td>Ni</td> <td>20</td> <td>21</td> <td>22</td> <td>23</td> <td>24</td> </tr> <tr> <td></td> <td>25</td> <td>26</td> <td>27</td> <td>28</td> <td></td> </tr> </table>	Ni	20	21	22	23	24		25	26	27	28	
Ni	20	21	22	23	24												
	25	26	27	28													



安装说明MAH556

www.staubli.com/electrical

插头 AL-4...-39

直插式, Ø 4 mm, 采用弹簧MULTILAM技术, 用于自组装测试导线。

焊接



订货号	型号	额定电压/额定电流	导线 (A)		*标准颜色
64.2050-*	AL-4N-39	AC 30 V/32 A DC 60 V/32 A	max. Ø 3.9 mm 2.5 mm ²	Ni	21 22 23 24 25 29
64.2051-*	AL-4A-39	AC 30 V/32 A DC 60 V/32 A	max. Ø 3.9 mm 2.5 mm ²	Au	21 22 23 24 25 29



可选颜色 27

更多信息, 第 6 页



安装说明 MA171

www.staubli.com/electrical

插头 AM-4N-46

直插式, Ø 4 mm, 采用弹簧MULTILAM技术, 用于自组装测试导线。

螺纹连接



订货号	型号	额定电压/额定电流	导线 (A)		*标准颜色
64.2056-*	AM-4N-46	AC 30 V/32 A DC 60 V/32 A	max. Ø 4.6 mm 2.5 mm ²	Ni	21 22



安装说明 MA171

www.staubli.com/electrical



可选颜色 23 24 25

更多信息, 第 6 页

插头 ACR...-4...-39

直插式, Ø 4 mm, 采用弹簧MULTILAM技术, 用于自组装测试导线。

压接连接

ACR...-4N-39



ACR...-4A-39

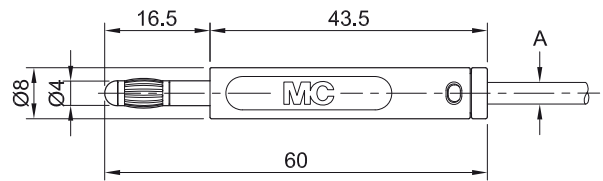

订货号	型号	额定电压/额定电流	导线 (A)			*标准颜色
64.2052-*	ACR10-4N-39	AC 30 V/19 A DC 60 V/19 A	max. Ø 3.9 mm	1.0 mm ²	Ni	21 22 23 24 25 29
64.2053-*	ACR10-4A-39	AC 30 V/19 A DC 60 V/19 A	max. Ø 3.9 mm	1.0 mm ²	Au	21 22 23 24 25 29
64.2054-*	ACR25-4N-39	AC 30 V/32 A DC 60 V/32 A	max. Ø 3.9 mm	2.5 mm ²	Ni	21 22 23 24 25 29
64.2055-*	ACR25-4A-39	AC 30 V/32 A DC 60 V/32 A	max. Ø 3.9 mm	2.5 mm ²	Au	21 22 23 24 25 29



可选颜色 26 27

更多信息, 第 6 页



安装说明 MA171

www.staubli.com/electrical

插头 GL-438...

直插式, Ø 4 mm, 采用弹簧MULTILAM技术, 用于自组装测试导线。带伸缩套管可防止意外触摸。

多种连接方式:

GL-438-L: 焊接
GL-438: 螺纹连接

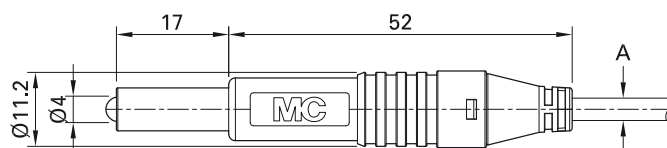

订货号	型号	额定电压/额定电流	导线 (A)		*标准颜色																
64.9701-*	GL-438	AC 30 V/32 A DC 60 V/32 A	<table border="1"> <tr> <td>PVC</td> <td>TPE</td> <td>Ø 3.9 mm</td> <td rowspan="2">2.5 mm²</td> </tr> <tr> <td>SIL</td> <td>Ø 3.9 mm</td> </tr> </table>	PVC	TPE	Ø 3.9 mm	2.5 mm ²	SIL	Ø 3.9 mm	Ni	<table border="1"> <tr> <td>21</td> <td>22</td> <td>23</td> <td>24</td> <td>25</td> </tr> <tr> <td colspan="5">29</td> </tr> </table>	21	22	23	24	25	29				
PVC	TPE	Ø 3.9 mm	2.5 mm ²																		
SIL	Ø 3.9 mm																				
21	22	23	24	25																	
29																					
64.2010-*	GL-438-L	AC 30 V/32 A DC 60 V/32 A	<table border="1"> <tr> <td>PVC</td> <td>TPE</td> <td>Ø 3.9 mm</td> <td rowspan="2">2.5 mm²</td> </tr> <tr> <td>SIL</td> <td>Ø 3.9 mm</td> </tr> </table>	PVC	TPE	Ø 3.9 mm	2.5 mm ²	SIL	Ø 3.9 mm	Ni	<table border="1"> <tr> <td>21</td> <td>22</td> <td>23</td> <td>24</td> <td>25</td> </tr> <tr> <td colspan="5">29</td> </tr> </table>	21	22	23	24	25	29				
PVC	TPE	Ø 3.9 mm	2.5 mm ²																		
SIL	Ø 3.9 mm																				
21	22	23	24	25																	
29																					

零件

64.2040-*	KT-GL-438	绝缘套
64.2030	LS-GL-438	金属件适用于 GL-438
64.2020	LS-GL-438-L	金属件适用于 GL-438-L



安装说明 MA170

www.staubli.com/electrical

插座 BL-4...-39

Ø 4 mm直插式硬质插座,用于自组装测试导线。

焊接

BL-4N-39

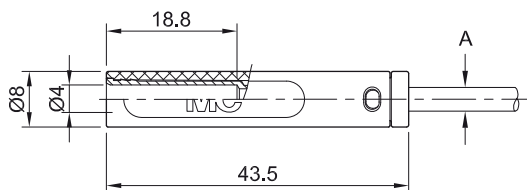

BL-4A-39



订货号	型号	额定电压/额定电流	导线 (A)		*标准颜色
64.2060-*	BL-4N-39	AC 30 V/32 A DC 60 V/32 A	max. Ø 3.9 mm 2.5 mm ²	Ni	21 22 23 24 25 29
64.2061-*	BL-4A-39	AC 30 V/32 A DC 60 V/32 A	max. Ø 3.9 mm 2.5 mm ²	Au	21 22 23 24 25 29



可选颜色 26 27

更多信息, 第 6页



安装说明 MA171

www.staubli.com/electrical

插座 BCR...-4...-39

Ø 4 mm直插式硬质插座,用于自组装测试导线。

压接连接

BCR...-4A-39

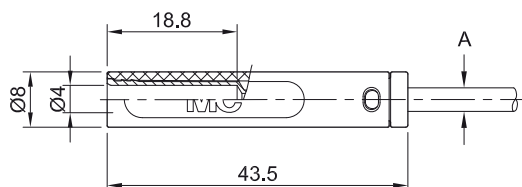

BCR...-4N-39

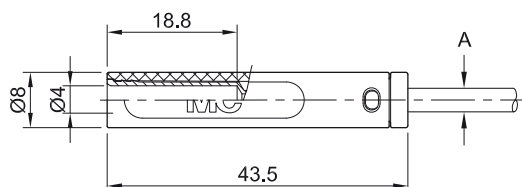

订货号	型号	额定电压/额定电流	导线 (A)			*标准颜色
64.2062-*	BCR10-4N-39	AC 30 V/19 A DC 60 V/19 A	max. Ø 3.9 mm	1.0 mm ²	Ni	21 22 23 24 25 29
64.2063-*	BCR10-4A-39	AC 30 V/19 A DC 60 V/19 A	max. Ø 3.9 mm	1.0 mm ²	Au	21 22 23 24 25 29
64.2064-*	BCR25-4N-39	AC 30 V/32 A DC 60 V/32 A	max. Ø 3.9 mm	2.5 mm ²	Ni	21 22 23 24 25 29
64.2065-*	BCR25-4A-39	AC 30 V/32 A DC 60 V/32 A	max. Ø 3.9 mm	2.5 mm ²	Au	21 22 23 24 25 29



安装说明 MA171

www.staubli.com/electrical



可选颜色 26 27

更多信息, 第 6 页

插头 KLS4

Ø 4 mm, 采用弹簧MULTILAM技术, 用于压接 压接
多股线缆。

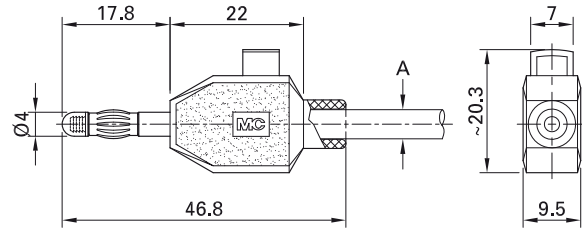

订货号	型号	额定电压/额定电流	导线 (A)	*标准颜色
22.3006-*	KLS4	AC 30 V/10 A DC 60 V/10 A	最大 Ø 4.8 mm 2.5 mm ²	Ni 21 22



用户信息 **i023**

www.staubli.com/electrical

插头 SLS425-SW...

直角式, \varnothing 4 mm, 采用弹簧MULTILAM技术, 焊接
用于自组装测试导线, 带硬质绝缘套管。有镀
镍和镀金型号可供选择。

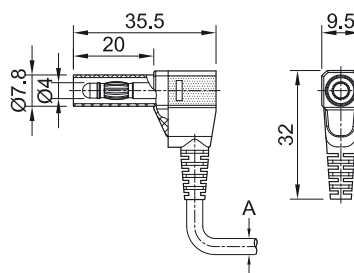

订货号	型号	额定电压/额定电流	导线 (A)			*标准颜色
22.2667-*	SLS425-SW	500 V, CAT II/32 A	最大 \varnothing 3.9 mm	2.5 mm ²	Ni	21 22
22.2668-*	SLS425-SW/A	500 V, CAT II/32 A	最大 \varnothing 3.9 mm	2.5 mm ²	Au	21 22

零件

22.2370-*	KT425-SW	绝缘套 (*标准颜色请参考 SLS425-SW)
22.1042	LS425-SW	金属件, 适用于: SLS425-SW
22.1045	LS425-SW/A	金属件, 适用于: SLS425-SW/A



安装说明 MA107

www.staubli.com/electrical



可选颜色 20 23 24 25 26

更多信息, 第6页

插头 SKLS4

带硬质绝缘套管的 $\varnothing 4$ mm插头。采用弹簧MULTILAM技术,可用于压接多股线缆。

压接

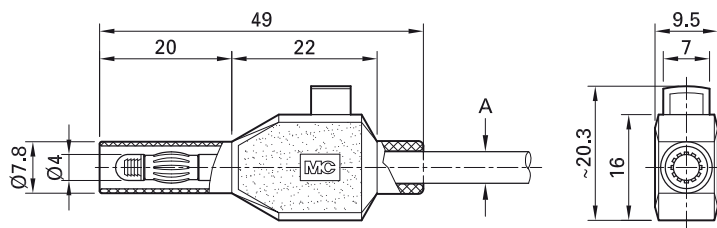

订货号	型号	额定电压/额定电流	导线 (A)		*标准颜色
22.3007-*	SKLS4	600 V, CAT II/10 A ¹⁾	最大 $\varnothing 4.8$ mm 2.5 mm ²	Ni CE UK CA	21 22

¹⁾ 此夹式插头不能进行带负载安装。



用户信息 **i005**

www.staubli.com/electrical

插头 XZGL-425

堆叠式, $\varnothing 4$ mm, 采用弹簧MULTILAM技术, 用于自组装测试导线。产品带有伸缩套管可防止意外触摸。由于插头装有防护颈圈, 电气间隙和爬电距离增加, 因此, 装配此款插头

后, 即使一些老式测试仪器没有安装安全插座, 不符合600 V CAT II的安全标准, 测试导线也可以与之安全连接。

螺纹连接。

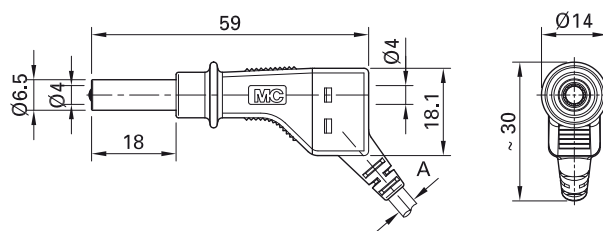

订货号	型号	额定电压/额定电流	导线 (A)			*标准颜色										
66.9328-*	XZGL-425	600 V, CAT II/32 A	最小 $\varnothing 3,4$ mm 最大 $\varnothing 3,9$ mm	1.0 mm ² ... 2.5 mm ²	Ni	<table border="1"> <tr> <td>20</td> <td>21</td> <td>22</td> <td>23</td> <td>24</td> </tr> <tr> <td>25</td> <td>26</td> <td>27</td> <td>28</td> <td></td> </tr> </table>	20	21	22	23	24	25	26	27	28	
20	21	22	23	24												
25	26	27	28													



安装说明MAH558

www.staubli.com/electrical

插头 X-GL-438

直插式, \varnothing 4 mm, 采用弹簧MULTILAM技术, 用于自组装测试导线。产品带有伸缩套管可防止意外触摸。由于插头装有防护颈圈, 电气间隙和爬电距离增加, 因此, 装配此款插头

后, 即使一些老式测试仪器没有安装安全插座, 不符合600 V CAT II的安全标准, 测试导线也可以与之安全连接。

螺纹连接。

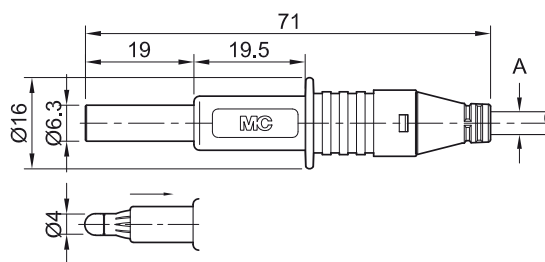

订货号	型号	额定电压/额定电流	导线 (A)		*标准颜色
66.9584-*	X-GL-438	600 V, CAT II/32 A	最大 \varnothing 3.9 mm 2.5 mm ²	Ni	21 22 23



安装说明 MA170

www.staubli.com/electrical

SLQ-4... SLM-4...

堆叠式, Ø 4 mm, 采用弹簧MULTILAM技术, 用于自组装测试导线, 带硬质绝缘套管。

多种连接方式:

SLM-4...: 螺纹连接

SLQ-4...: 十字孔焊接

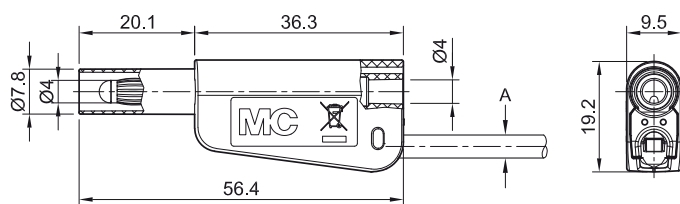

订货号	型号	额定电压/额定电流	导线 (A)		*标准颜色																				
66.2018-*	SLQ-4N-39	1000 V, CAT II/19 A 600 V, CAT III/19 A	<table border="1"> <tr><td>PVC</td><td>Ø 3.9 mm</td></tr> <tr><td>SIL</td><td>Ø 3.9 mm</td></tr> </table>	PVC	Ø 3.9 mm	SIL	Ø 3.9 mm	1.0 mm ²	Ni	<table border="1"> <tr><td>20</td><td>21</td><td>22</td><td>23</td><td>24</td></tr> <tr><td>25</td><td>26</td><td>27</td><td>28</td><td>29</td></tr> <tr><td>30</td><td></td><td></td><td></td><td></td></tr> </table>	20	21	22	23	24	25	26	27	28	29	30				
PVC	Ø 3.9 mm																								
SIL	Ø 3.9 mm																								
20	21			22	23	24																			
25	26	27	28	29																					
30																									
66.2019-*	SLQ-4A-39	Au																							
66.2020-*	SLM-4N-39	Ni																							
66.2021-*	SLM-4A-39	Au																							
66.2022-*	SLQ-4N-46	1000 V, CAT II/32 A 600 V, CAT III/32 A	<table border="1"> <tr><td>PVC</td><td>Ø 3.9 mm</td></tr> <tr><td>SIL</td><td>Ø 4.6 mm</td></tr> </table>	PVC	Ø 3.9 mm	SIL	Ø 4.6 mm	2.5 mm ²	Ni	<table border="1"> <tr><td>20</td><td>21</td><td>22</td><td>23</td><td>24</td></tr> <tr><td>25</td><td>26</td><td>27</td><td>28</td><td>29</td></tr> <tr><td>30</td><td></td><td></td><td></td><td></td></tr> </table>	20	21	22	23	24	25	26	27	28	29	30				
PVC	Ø 3.9 mm																								
SIL	Ø 4.6 mm																								
20	21			22	23	24																			
25	26	27	28	29																					
30																									
66.2023-*	SLQ-4A-46	Au																							
66.2024-*	SLM-4N-46	Ni																							
66.2025-*	SLM-4A-46	Au																							

零件

66.2026-*	KT-SL-4-39	绝缘套 适用于	SLQ-4N-39; SLQ-4A-39; SLM-4N-39; SLM-4A-39
66.2027-*	KT-SL-4-46	绝缘套 适用于	SLQ-4N-46; SLQ-4A-46; SLM-4N-46; SLM-4A-46
66.2028	LS-SLQ-4N	金属件 适用于	SLQ-4N-39; SLQ-4N-46
66.2029	LS-SLQ-4A	金属件 适用于	SLQ-4A-39; SLQ-4A-46
66.2030	LS-SLM-4N	金属件 适用于	SLM-4N-39; SLM-4N-46
66.2031	LS-SLM-4A	金属件 适用于	SLM-4A-39; SLM-4A-46



安装说明 MA167

www.staubli.com/electrical

插头 SAL-4...-39-TW

直插式，极其纤细， \varnothing 4 mm，采用弹簧 MULTILAM 技术，用于自组装测试导线，带硬质绝缘套管。有镀镍和镀金型号可供选择。

焊接

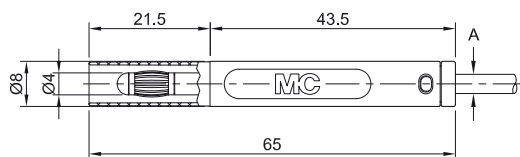

订货号	型号	额定电压/额定电流	导线 (A)			*标准颜色
66.2040-*	SAL-4N-39-TW	1000 V, CAT II/32 A 600 V, CAT III/32 A	max. \varnothing 3.9 mm	2.5 mm ²	Ni	21 22 23 24 25 29
66.2041-*	SAL-4A-39-TW	1000 V, CAT II/32 A 600 V, CAT III/32 A	max. \varnothing 3.9 mm	2.5 mm ²	Au	21 22 23 24 25 29



可选颜色 20 26 27 28

更多信息, 第 6 页



安装说明 MA171

www.staubli.com/electrical

插头 SACR...-4...-39-TW

直插式，极其纤细， \varnothing 4 mm，采用弹簧 MULTILAM 技术，用于自组装测试导线，带硬质绝缘套管。有镀镍和镀金型号可供选择。

压接连接

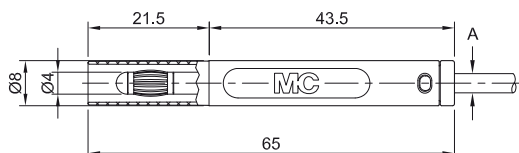

订货号	型号	额定电压/额定电流	导线 (A)			*标准颜色
66.2042-*	SACR10-4N-39-TW	1000 V, CAT II/19 A 600 V, CAT III/19 A	max. \varnothing 3.9 mm	1.0 mm ²	Ni	21 22 23 24 25 29
66.2043-*	SACR10-4A-39-TW	1000 V, CAT II/19 A 600 V, CAT III/19 A	max. \varnothing 3.9 mm	1.0 mm ²	Au	21 22 23 24 25 29
66.2044-*	SACR25-4N-39-TW	1000 V, CAT II/32 A 600 V, CAT III/32 A	max. \varnothing 3.9 mm	2.5 mm ²	Ni	21 22 23 24 25 29
66.2045-*	SACR25-4A-39-TW	1000 V, CAT II/32 A 600 V, CAT III/32 A	max. \varnothing 3.9 mm	2.5 mm ²	Au	21 22 23 24 25 29



安装说明 MA171

www.staubli.com/electrical



可选颜色 20 26 27 28

更多信息, 第 6 页

插头 SAM-4N-46

直插式, Ø 4 mm, 采用弹簧MULTILAM技术, 用于自组装测试导线, 带硬质绝缘套管。

螺纹连接

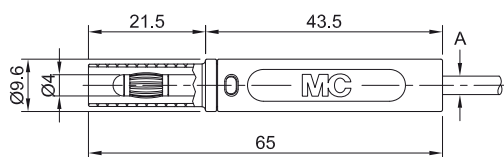

订货号	型号	额定电压/额定电流	导线 (A)		*标准颜色
66.2047-*	SAM-4N-46	1000 V, CAT II/32 A 600 V, CAT III/32 A	max. Ø 4.6 mm 2.5 mm ²	Ni	21 22 23 24 25 29



安装说明 MA171

www.staubli.com/electrical

插头 SACR25-4A-46

直插式, Ø 4 mm, 采用弹簧MULTILAM技术, 用于自组装测试导线, 带硬质绝缘套管。有镀镍和镀金型号可供选择。

压接连接

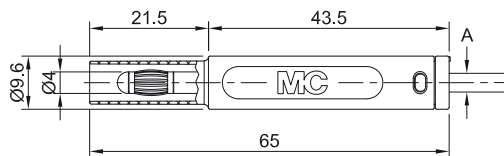

订货号	型号	额定电压/额定电流	导线 (A)		*标准颜色
66.2046-*	SACR25-4A-46	1000 V, CAT II/32 A 600 V, CAT III/32 A	max. Ø 4.6 mm 2.5 mm ²	Au	21 22 23 24 25 29



安装说明 MA171

www.staubli.com/electrical



可选颜色 20 26 27 28

更多信息, 第 6 页

插座 SBM-4N-46

直插式, 硬质, $\varnothing 4$ mm, 用于自组装测试导线。
可与带硬质绝缘套管的弹簧式 $\varnothing 4$ mm 插头连接。

螺纹连接

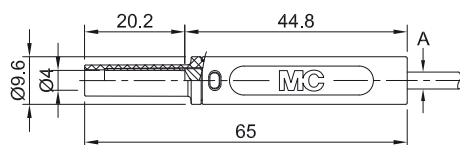

订货号	型号	额定电压/额定电流	导线 (A)		*标准颜色
66.2054-*	SBM-4N-46	1000 V, CAT II/32 A 600 V, CAT III/32 A	max. $\varnothing 4.6$ mm 2.5 mm ²	Ni	21 22 23 24 25 29



安装说明 MA171

www.staubli.com/electrical



可选颜色 20 26 27 28

更多信息, 第 6 页

插座 SBL-4...-39

直插式, 硬质, Ø 4 mm, 用于自组装测试导线, 可与带硬质绝缘套管的弹簧式 Ø 4 mm 插头连接。

焊接

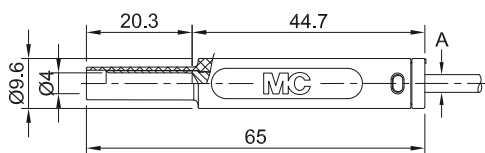

订货号	型号	额定电压/额定电流	导线 (A)		*标准颜色
66.2050-*	SBL-4N-39	1000 V, CAT II/32 A 600 V, CAT III/32 A	max. Ø 3.9 mm 2.5 mm ²	Ni	21 22 23 24 25 29
66.2051-*	SBL-4A-39	1000 V, CAT II/32 A 600 V, CAT III/32 A	max. Ø 3.9 mm 2.5 mm ²	Au	21 22 23 24 25 29



安装说明 MA171

www.staubli.com/electrical



可选颜色 20 26 27 28

更多信息, 第 6 页

插座 SBCR10-4...-39

直插式, 硬质, Ø 4 mm, 用于自组装测试导线, 可与带硬质绝缘套管的弹簧式 Ø 4 mm 插头连接。

压接连接

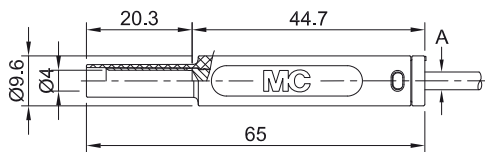

订货号	型号	额定电压/额定电流	导线 (A)		*标准颜色
66.2052-*	SBCR10-4N-39	1000 V, CAT II/19 A 600 V, CAT III/19 A	max. Ø 3.9 mm 1.0 mm ²	Ni	21 22 23 24 25 29
66.2053-*	SBCR10-4A-39	1000 V, CAT II/19 A 600 V, CAT III/19 A	max. Ø 3.9 mm 1.0 mm ²	Au	21 22 23 24 25 29



安装说明 MA171

www.staubli.com/electrical



可选颜色 20 26 27 28

更多信息, 第 6 页

焊入式/压入式/内置插座

压入式插座 LB4...

无绝缘, \varnothing 4 mm, 硬质, 滚压黄铜板, 插座压入塑料预打孔面板, 或焊接到印刷电路板上进行安装。

焊接

LB4

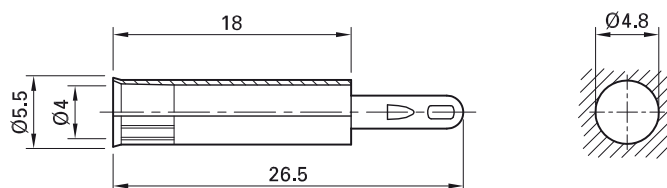

订货号	型号	额定电压/额定电流		
23.1003	LB4	AC 30 V/25 A DC 60 V/25 A	Au	

压入式插座 LB4-A

无绝缘, \varnothing 4 mm, 硬质, 冲压黄铜管, 插座压入预打孔塑料面板, 或焊接到印刷电路板上进行安装。

焊接

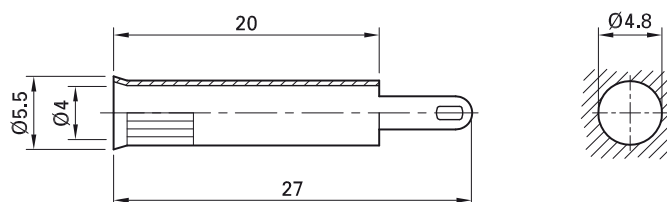
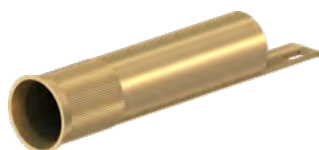

订货号	型号	额定电压/额定电流		
23.1004	LB4-A	AC 30 V/25 A DC 60 V/25 A	Au	

压入式插座 EB4-IF/A

带绝缘, $\varnothing 4$ mm, 硬质, 黄铜。插座压入塑料或金属等材质预打孔面板进行安装。

连接方式: 扁平连接片 4.8 mm x 0.8 mm

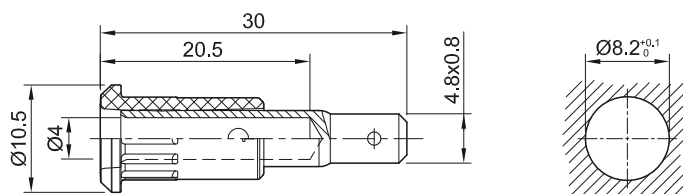

订货号	型号	额定电压/额定电流		*标准颜色										
64.3010-*	EB4-IF/A	AC 30 V/25 A DC 60 V/25 A	Au	<table border="1"> <tr> <td>20</td> <td>21</td> <td>22</td> <td>23</td> <td>24</td> </tr> <tr> <td>25</td> <td>26</td> <td>27</td> <td>28</td> <td>29</td> </tr> </table>	20	21	22	23	24	25	26	27	28	29
20	21	22	23	24										
25	26	27	28	29										

零件

64.3030-*	I-EB4-I	绝缘座
64.3020	B-EB4_AU	金属件



压入工具 MB4, 第127页

平面连接插座 FSH4, $8 \times 0,8$, 第125页



安装说明 MA169

www.staubli.com/electrical

压入式插座 EB4-IR/...

带绝缘, Ø4 mm, 硬质, 黄铜。插座压入塑料或金属等材质预打孔面板进行安装。

连接方式: 圆形针

EB4-IR/A



EB4-IR/N

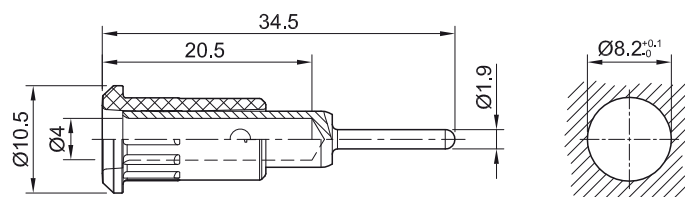

EB4-IR/A_1,2

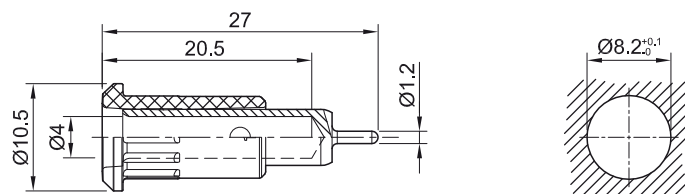

订货号	型号	额定电压/额定电流	连接方式		*标准颜色										
64.3012-*	EB4-IR/A	AC 30 V/25 A DC 60 V/25 A	圆形针 Ø 1.9 mm	Au	<table border="1"> <tr> <td>20</td><td>21</td><td>22</td><td>23</td><td>24</td> </tr> <tr> <td>25</td><td>26</td><td>27</td><td>28</td><td>29</td> </tr> </table>	20	21	22	23	24	25	26	27	28	29
20	21	22	23	24											
25	26	27	28	29											
64.3011-*	EB4-IR/N	AC 30 V/25 A DC 60 V/25 A	圆形针 Ø 1.9 mm	Ni	<table border="1"> <tr> <td>20</td><td>21</td><td>22</td><td>23</td><td>24</td> </tr> <tr> <td>25</td><td>26</td><td>27</td><td>28</td><td>29</td> </tr> </table>	20	21	22	23	24	25	26	27	28	29
20	21	22	23	24											
25	26	27	28	29											
64.3014-*	EB4-IR/A_1,2	AC 30 V/25 A DC 60 V/25 A	圆形针 Ø 1.2 mm	Au	<table border="1"> <tr> <td>21</td><td>22</td><td>23</td><td>24</td><td>25</td> </tr> </table>	21	22	23	24	25					
21	22	23	24	25											

零件

64.3030-*	I-EB4-I	绝缘座
64.3021	B-EB4-IR_AU	金属件 适用于 EB4-IR/A
64.3022	B-EB4-IR_NI	金属件 适用于 EB4-IR/N



压入工具 MB4, 第127页



安装说明 MA169

www.staubli.com/electrical

压入式插座 EB4-IFA/N

带绝缘, \varnothing 4 mm, 硬质, 冲压或滚压黄铜板。
插座压入塑料或金属等材质预打孔面板进行
安装。

连接方式: 扁平连接片 4.8 mm x 0.8 mm, 可
90°弯曲, 但仅能弯曲一次。

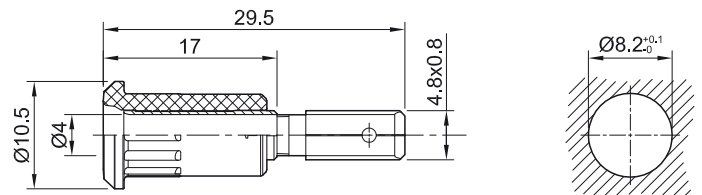

订货号	型号	额定电压/额定电流		*标准颜色										
64.3013-*	EB4-IFA/N	AC 30 V/25 A DC 60 V/25 A	Ni	<table border="1"> <tr> <td>20</td> <td>21</td> <td>22</td> <td>23</td> <td>24</td> </tr> <tr> <td>25</td> <td>26</td> <td>27</td> <td>28</td> <td>29</td> </tr> </table>	20	21	22	23	24	25	26	27	28	29
20	21	22	23	24										
25	26	27	28	29										

零件

64.3031-*	I-EB4-IFA	绝缘座
23.5026	B-EB4-B	金属件



压入工具 MB4, 第127页

平面连接插座 FSH4, 8x0,8, 第125页



安装说明 MA169

www.staubli.com/electrical

接地插座 MSLB4-G

无绝缘, Ø4 mm, 硬质, 黄铜。可与带硬质绝缘套管的弹簧式 Ø4 mm 插头连接。插座可直接安装在金属预打孔面板上。

连接方式: M4螺栓

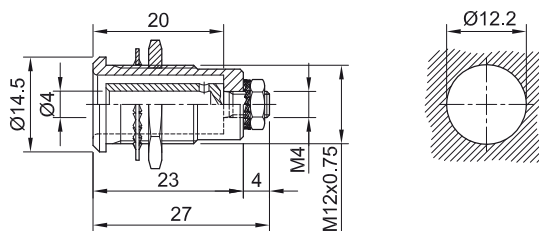

订货号	型号	额定电压/额定电流		
23.3090	MSLB4-G	AC 30 V/32 A DC 60 V/32 A	Ni	

可提供的安装材料

23.5118	MU/M12x0,75	六角螺母	第122页
22.6610	MU0,5D/M4N	六角螺母	第122页
23.5117	FS/M12	弹簧垫圈	第124页
22.6533	FS/M4	弹簧垫圈	第124页

面板安装插座 LB4H-IE/N

带绝缘, $\varnothing 4$ mm, 硬质, 黄铜。插座螺纹安装于
预打孔面板。

连接方式: 焊接

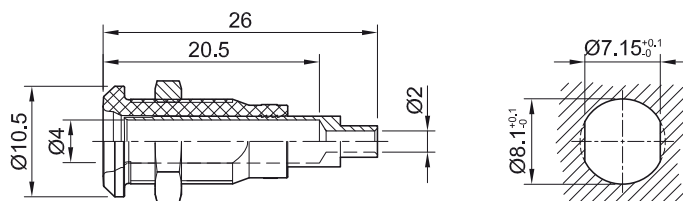

订货号	型号	额定电压/额定电流		*标准颜色										
64.3042-*	LB4H-IE/N	AC 30 V/25 A DC 60 V/25 A	Ni	<table border="1"> <tr> <td>20</td> <td>21</td> <td>22</td> <td>23</td> <td>24</td> </tr> <tr> <td>25</td> <td>26</td> <td>27</td> <td>28</td> <td>29</td> </tr> </table>	20	21	22	23	24	25	26	27	28	29
20	21	22	23	24										
25	26	27	28	29										

零件

64.3051-*	BI-LB4x-IE/N	金属件 (不带螺母)		
23.5112	MU/M8x0,5	六角螺母		第122页



安装说明 MA168

www.staubli.com/electrical

面板安装插座 LB4H-IF/A

带绝缘, $\varnothing 4$ mm, 硬质, 黄铜。插座螺纹安装于
预打孔面板。

连接方式: 扁平连接片 4.8 mm x 0.8 mm

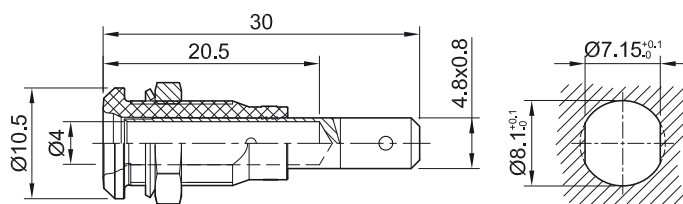

订货号	型号	额定电压/额定电流		*标准颜色										
64.3040-*	LB4H-IF/A	AC 30 V/25 A DC 60 V/25 A	Au	<table border="1"> <tr> <td>20</td> <td>21</td> <td>22</td> <td>23</td> <td>24</td> </tr> <tr> <td>25</td> <td>26</td> <td>27</td> <td>28</td> <td>29</td> </tr> </table>	20	21	22	23	24	25	26	27	28	29
20	21	22	23	24										
25	26	27	28	29										

零件

64.3050-*	BI-LB4x-IF/A	金属件(不带螺母)	
23.5112	MU/M8x0,5	六角螺母	第122页
23.5107	SP4	垫圈	第123页



平面连接插座 FSH4,8x0,8, 第125页



安装说明 MA168

www.staubli.com/electrical

接线柱 PK4-T

带绝缘, \varnothing 4 mm, 硬质, 黄铜, 绝缘头不可拆卸。带 \varnothing 2.5 mm 十字孔可与电线快速链接。与抗旋转接线片配合, 安装在厚度为 4 mm 的

前面板上。

连接方式: M4螺栓

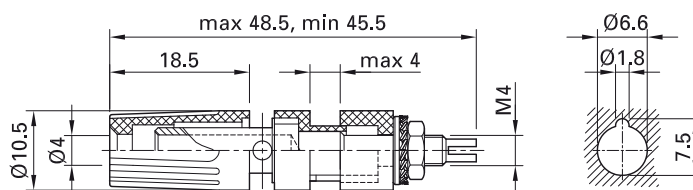

订货号	型号	额定电压/额定电流		*标准颜色										
23.0330-*	PK4-T	AC 30 V/35 A DC 60 V/35 A	Ni	<table border="1"> <tr> <td>20</td> <td>21</td> <td>22</td> <td>23</td> <td>24</td> </tr> <tr> <td>25</td> <td>29</td> <td></td> <td></td> <td></td> </tr> </table>	20	21	22	23	24	25	29			
20	21	22	23	24										
25	29													

安装插座 SAB4-G...

绝缘型硬质插座, Ø 4 mm, 黄铜。可与带硬质绝缘套管的弹簧式 Ø 4 mm 插头连接。插座表面安装于塑料或金属等材质预打孔面板。

连接方式: M4螺栓

SAB4-G



SAB4-G/N-X

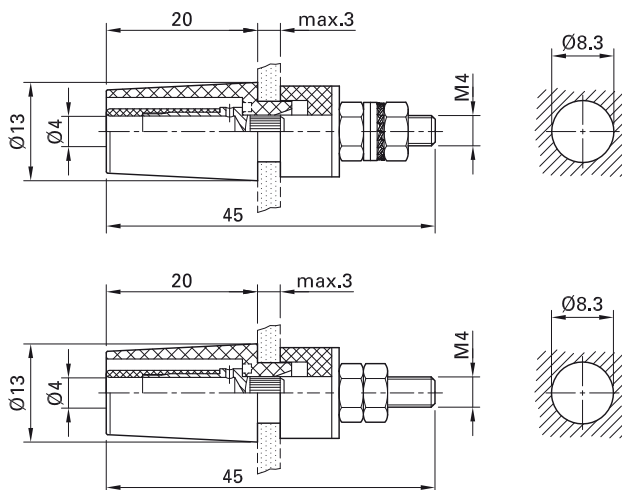

订货号	型号	额定电压/额定电流		*标准颜色										
23.3050-*	SAB4-G	1000 V, CAT II/32 A	Au c US	<table border="1"> <tr> <td>20</td><td>21</td><td>22</td><td>23</td><td>24</td> </tr> <tr> <td>25</td><td>26</td><td>27</td><td>28</td><td>29</td> </tr> </table>	20	21	22	23	24	25	26	27	28	29
20	21	22	23	24										
25	26	27	28	29										
49.7042-*	SAB4-G/N-X	1000 V, CAT II/32 A	Ni c US	<table border="1"> <tr> <td>20</td><td>21</td><td>22</td><td>23</td><td>24</td> </tr> <tr> <td>25</td><td>26</td><td>27</td><td>28</td><td>29</td> </tr> </table>	20	21	22	23	24	25	26	27	28	29
20	21	22	23	24										
25	26	27	28	29										

可提供的安装材料

22.6509	MU0,8D/M4	2个六角螺母, 适用于 SLB4-G	第122页
22.6539	MU0,8D/M4N	2个六角螺母, 适用于 SLB4-G/N-X	第122页
22.6511	U/M4	2个垫圈, 适用于 SLB4-G	第123页
22.6516	U/4,3x12	垫圈, 适用于 SLB4-G, SLB4-G/N-X	第123页
22.6533	FS/M4	弹簧垫圈, 适用于 SLB4-G	第124页



管状扳手 SS2, 第126页



安装说明 MA153

www.staubli.com/electrical

安装插座 SAB4-F/A

绝缘型硬质插座, \varnothing 4 mm, 黄铜。可与带硬质绝缘套管的弹簧式 \varnothing 4 mm 插头连接。插座表面安装于塑料或金属等材质预打孔面板。

连接方式: 扁平连接片 4.8 mm x 0.8 mm, 可 90° 弯曲, 但仅能弯曲一次。

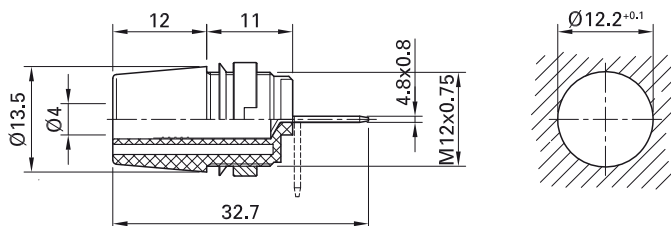

订货号	型号	额定电压/额定电流		*标准颜色										
23.3110-*	SAB4-F/A	1000 V, CAT II/20 A	Ni c US	<table border="1"> <tr> <td>20</td> <td>21</td> <td>22</td> <td>23</td> <td>24</td> </tr> <tr> <td>25</td> <td></td> <td></td> <td></td> <td></td> </tr> </table>	20	21	22	23	24	25				
20	21	22	23	24										
25														

可提供的安装材料

23.5116	MUR-S/M12x0,75	圆形螺母	第123页
23.5108	SSP4	垫圈	第123页



可选颜色 26

更多信息, 第6页



平面连接插座 FSH4, 8x0,8, 第125页

管状扳手 SS2, SS425, 第126页



安装说明 MA152

www.staubli.com/electrical

万能式插座 XUB-G

绝缘型硬质插座, Ø 4 mm, 黄铜。可与带硬质绝缘套管的弹簧式 Ø 4 mm 插头连接。插座表面安装、沉头或压入式安装于塑料或金属等材料预打孔面板。

连接方式: M4螺栓

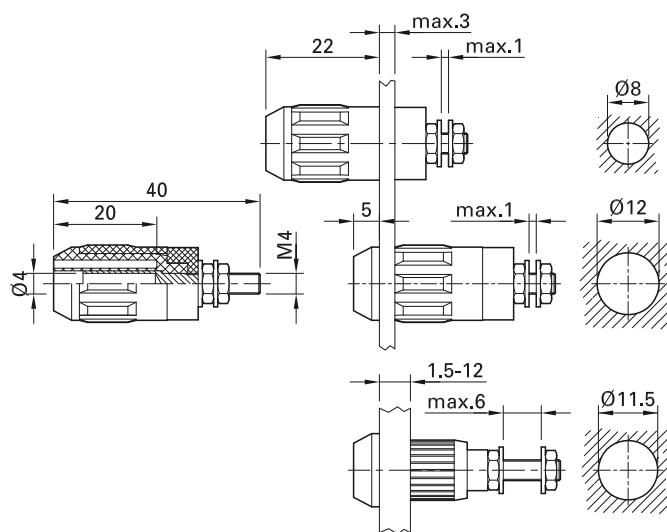

订货号	型号	额定电压/额定电流		*标准颜色										
66.9684-*	XUB-G	600 V ¹⁾ , CAT II/20 A 1000 V ²⁾ , CAT II/20 A	Ni c us	<table border="1"> <tr> <td>20</td> <td>21</td> <td>22</td> <td>23</td> <td>24</td> </tr> <tr> <td>25</td> <td>27</td> <td>29</td> <td></td> <td></td> </tr> </table>	20	21	22	23	24	25	27	29		
20	21	22	23	24										
25	27	29												

¹⁾ 表面安装

²⁾ 沉头安装或压入式安装



可选颜色 26 28

更多信息, 第6页



压入工具 MB4-S, 第127页



安装说明 MAH507

www.staubli.com/electrical

压入式插座 SEB4-F...

绝缘型硬质插座, Ø 4 mm。可与带硬质绝缘套管的弹簧式 Ø 4 mm 插头连接。绝缘材料 UL94 V-0。插座可以压入式安装在塑料或金属材质的面板上。

连接方式: 扁平连接片

SEB4-F

SEB4-F/N

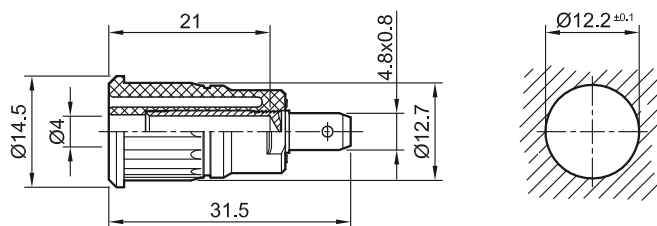

SEB4-F6,3

SEB4-F6,3/N

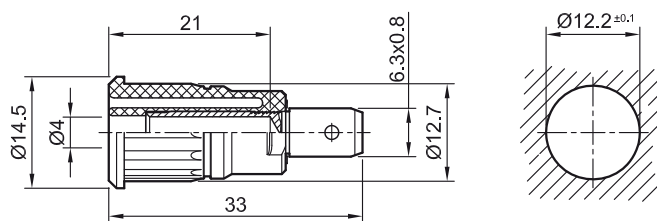

订货号	型号	额定电压/额定电流	连接方式		*标准颜色										
23.3120-*	SEB4-F	1000 V, CAT III/24 A 600 V, CAT IV/24 A	扁平连接片 4.8 mm × 0.8 mm	Au c US	<table border="1"> <tr><td>20</td><td>21</td><td>22</td><td>23</td><td>24</td></tr> <tr><td>25</td><td>26</td><td>27</td><td>28</td><td>29</td></tr> </table>	20	21	22	23	24	25	26	27	28	29
20	21	22	23	24											
25	26	27	28	29											
49.7079-*	SEB4-F/N	1000 V, CAT III/24 A 600 V, CAT IV/24 A	扁平连接片 4.8 mm × 0.8 mm	Ni c US	<table border="1"> <tr><td>20</td><td>21</td><td>22</td><td>23</td><td>24</td></tr> <tr><td>25</td><td>26</td><td>27</td><td>28</td><td>29</td></tr> </table>	20	21	22	23	24	25	26	27	28	29
20	21	22	23	24											
25	26	27	28	29											
23.3150-*	SEB4-F6,3	1000 V, CAT III/32 A 600 V, CAT IV/32 A	扁平连接片 6.3 mm × 0.8 mm	Au c US	<table border="1"> <tr><td>20</td><td>21</td><td>22</td><td>23</td><td>24</td></tr> <tr><td>25</td><td>26</td><td>27</td><td>28</td><td>29</td></tr> </table>	20	21	22	23	24	25	26	27	28	29
20	21	22	23	24											
25	26	27	28	29											
49.7073-*	SEB4-F6,3/N	1000 V, CAT III/32 A 600 V, CAT IV/32 A	扁平连接片 6.3 mm × 0.8 mm	Ni c US	<table border="1"> <tr><td>20</td><td>21</td><td>22</td><td>23</td><td>24</td></tr> <tr><td>25</td><td>26</td><td>27</td><td>28</td><td>29</td></tr> </table>	20	21	22	23	24	25	26	27	28	29
20	21	22	23	24											
25	26	27	28	29											



可选颜色 30

更多信息, 第6页



压入工具 MB4-S, 第127页

平面连接插座 FSH4,8x0,8, 第125页



安装说明 MA104

www.staubli.com/electrical

压入式插座 SEB4-...

绝缘型硬质插座, Ø 4 mm, 黄铜。可与带硬质绝缘套管的弹簧式 Ø 4 mm 插头连接。插座

压入塑料或金属等材料预打孔面板进行安装。
连接方式: 焊接。

SEB4-R



SEB4-R/N



SEB4-E/A



SEB4-E

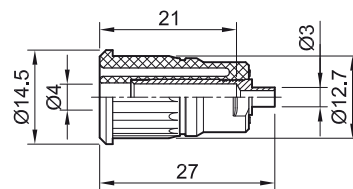
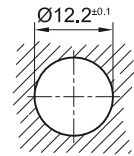
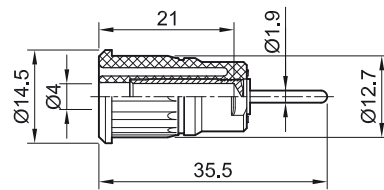

订货号	型号	额定电压/额定电流	连接方式		*标准颜色										
23.3130-*	SEB4-R	1000 V, CAT III/24 A 600 V, CAT IV/24 A	圆形针 Ø 1.9 mm	Au US	<table border="1"> <tr><td>20</td><td>21</td><td>22</td><td>23</td><td>24</td></tr> <tr><td>25</td><td>26</td><td>27</td><td>28</td><td>29</td></tr> </table>	20	21	22	23	24	25	26	27	28	29
20	21	22	23	24											
25	26	27	28	29											
49.7080-*	SEB4-R/N	1000 V, CAT III/24 A 600 V, CAT IV/24 A	圆形针 Ø 1.9 mm	Ni US	<table border="1"> <tr><td>20</td><td>21</td><td>22</td><td>23</td><td>24</td></tr> <tr><td>25</td><td>26</td><td>27</td><td>28</td><td>29</td></tr> </table>	20	21	22	23	24	25	26	27	28	29
20	21	22	23	24											
25	26	27	28	29											
66.7092-*	SEB4-E/A	1000 V, CAT III/24 A 600 V, CAT IV/24 A	焊接	Au US	<table border="1"> <tr><td>20</td><td>21</td><td>22</td><td>23</td><td>24</td></tr> <tr><td>25</td><td>26</td><td>27</td><td>28</td><td>29</td></tr> </table>	20	21	22	23	24	25	26	27	28	29
20	21	22	23	24											
25	26	27	28	29											
49.7091-*	SEB4-E	1000 V, CAT III/24 A 600 V, CAT IV/24 A	焊接	Ni US	<table border="1"> <tr><td>20</td><td>21</td><td>22</td><td>23</td><td>24</td></tr> <tr><td>25</td><td>26</td><td>27</td><td>28</td><td>29</td></tr> </table>	20	21	22	23	24	25	26	27	28	29
20	21	22	23	24											
25	26	27	28	29											



可选颜色 30

更多信息, 第6页



压入工具 MB4-S, 第127页



安装说明 MA104

www.staubli.com/electrical

压入式插座 SEB4-...

绝缘型硬质插座, Ø 4 mm, 黄铜。可与带硬质绝缘套管的弹簧式 Ø 4 mm 插头连接。插座

压入塑料或金属等材质预打孔面板进行安装。

连接方式: M4螺栓和焊接孔。

SEB4-G

SEB4-G/N-X

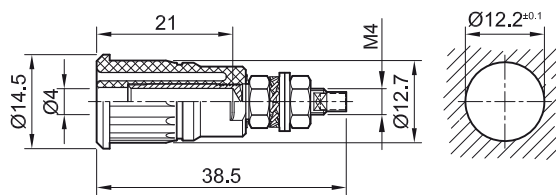

SEB4-GK

SEB4-GK/N

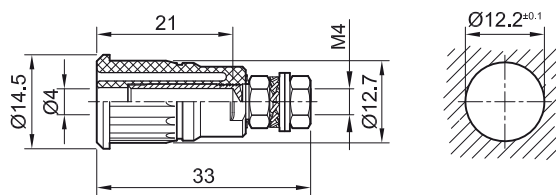

订货号	型号	额定电压/额定电流	连接方式		*标准颜色
23.3140-*	SEB4-G	1000 V, CAT III/32 A 600 V, CAT IV/32 A	M4螺栓和焊接孔	Au cRU US	20 21 22 23 24 25 26 27 28 29
49.7092-*	SEB4-G/N-X	1000 V, CAT III/32 A 600 V, CAT IV/32 A	M4螺栓和焊接孔	Ni cRU US	20 21 22 23 24 25 26 27 28 29
66.3140-*	SEB4-GK	1000 V, CAT III/32 A 600 V, CAT IV/32 A	M4螺栓	Au cRU US	20 21 22 23 24 25 26 27 28 29
66.7049-*	SEB4-GK/N	1000 V, CAT III/32 A 600 V, CAT IV/32 A	M4螺栓	Ni cRU US	20 21 22 23 24 25 26 27 28 29

可提供的安装材料

22.6509	MU0,8D/M4	2 个六角螺母	SEB4-G; SEB4-GK	第122页
22.6539	MU0,8D/M4N	2 个六角螺母	SEB4-G/N-X; SEB4-GK/N	第122页
22.6511	U/M4	2 个垫圈	SEB4-G; SEB4-GK	第123页
22.6533	FS/M4	弹簧垫圈	SEB4-G; SEB4-GK	第124页



安装说明 MA104

www.staubli.com/electrical



可选颜色 30

更多信息, 第6页



压入工具 MB4-S, 第127页

压入式插座 SEB4-F/A

绝缘型硬质插座, Ø 4 mm, 黄铜。可与带硬质绝缘套管的弹簧式 Ø 4 mm 插头连接。插座压入塑料或金属等材质预打孔面板进行安装。

连接方式: 扁平连接片 4.8 mm × 0.8 mm,
可90°弯曲, 但仅能弯曲一次。

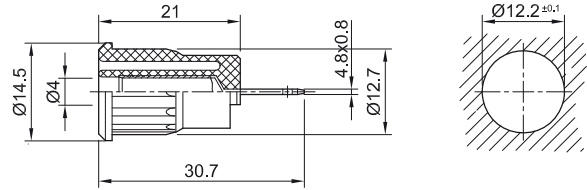

订货号	型号	额定电压/额定电流		*标准颜色										
23.3160-*	SEB4-F/A	1000 V, CAT III/24 A 600 V, CAT IV/24 A	Ni c US	<table border="1"> <tr> <td>20</td> <td>21</td> <td>22</td> <td>23</td> <td>24</td> </tr> <tr> <td>25</td> <td>27</td> <td>28</td> <td>29</td> <td></td> </tr> </table>	20	21	22	23	24	25	27	28	29	
20	21	22	23	24										
25	27	28	29											



安装说明 MA104

www.staubli.com/electrical



平面连接插座 FSH4,8x0,8, 第125页

压入工具 MB4-S, 第127页

面板安装插座 SLB4-F/A

绝缘型硬质插座, Ø 4 mm, 黄铜。可与带硬质绝缘套管的弹簧式 Ø 4 mm 插头连接。插座螺纹安装于塑料或金属等材质预打孔面板。

连接方式: 扁平连接片 4.8 mm × 0.8 mm,
可90°弯曲, 但仅能弯曲一次。

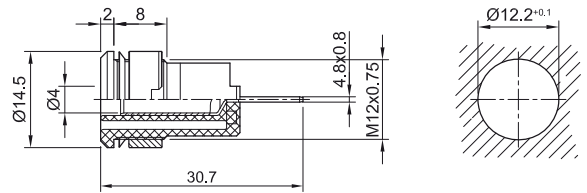

订货号	型号	额定电压/额定电流		*标准颜色										
23.3070-*	SLB4-F/A	1000 V, CAT III/24 A 600 V, CAT IV/24 A	Ni c US	<table border="1"> <tr> <td>20</td> <td>21</td> <td>22</td> <td>23</td> <td>24</td> </tr> <tr> <td>25</td> <td>26</td> <td>27</td> <td>28</td> <td>29</td> </tr> </table>	20	21	22	23	24	25	26	27	28	29
20	21	22	23	24										
25	26	27	28	29										

零件

23.3030-*	BI-SLB4-F/A			
23.5120	MUR/M12x0,75	圆形螺母		第123页
23.5108	SSP4	垫圈		第123页



安装说明 MA152

www.staubli.com/electrical



平面连接插座 FSH4,8x0,8, 第125页

管状扳手 SS2, SS425, 第126页

面板安装插座 SLB4-F...

绝缘型硬质插座, Ø 4 mm, 黄铜。可与带硬质绝缘套管的弹簧式 Ø 4 mm 插头连接。绝缘材

料UL94V-0。插座螺纹安装于塑料或金属等材质预打孔面板。

连接方式: 扁平连接片

SLB4-F

SLB4-F/N-X

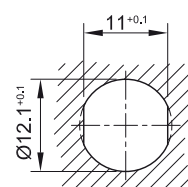
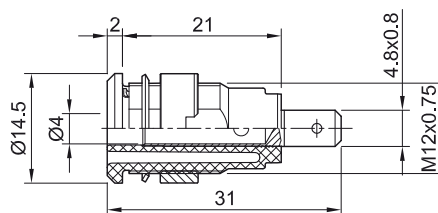

SLB4-F6,3

SLB4-F6,3/N-X

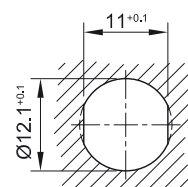
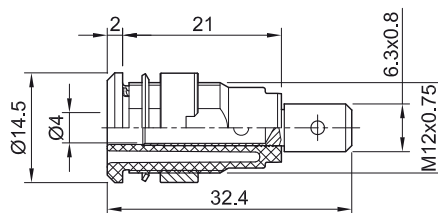

订货号	型号	额定电压/额定电流	连接方式		*标准颜色										
23.3000-*	SLB4-F	1000 V, CAT III/24 A 600 V, CAT IV/24 A	扁平连接片 4.8 mm × 0.8 mm	Au c US	<table border="1"> <tr><td>20</td><td>21</td><td>22</td><td>23</td><td>24</td></tr> <tr><td>25</td><td>26</td><td>27</td><td>28</td><td>29</td></tr> </table>	20	21	22	23	24	25	26	27	28	29
20	21	22	23	24											
25	26	27	28	29											
49.7044-*	SLB4-F/N-X	1000 V, CAT III/24 A 600 V, CAT IV/24 A	扁平连接片 4.8 mm × 0.8 mm	Ni c US	<table border="1"> <tr><td>20</td><td>21</td><td>22</td><td>23</td><td>24</td></tr> <tr><td>25</td><td>26</td><td>27</td><td>28</td><td>29</td></tr> </table>	20	21	22	23	24	25	26	27	28	29
20	21	22	23	24											
25	26	27	28	29											
23.3060-*	SLB4-F6,3	1000 V, CAT III/32 A 600 V, CAT IV/32 A	扁平连接片 6.3 mm × 0.8 mm	Au c US	<table border="1"> <tr><td>20</td><td>21</td><td>22</td><td>23</td><td>24</td></tr> <tr><td>25</td><td>26</td><td>27</td><td>28</td><td>29</td></tr> </table>	20	21	22	23	24	25	26	27	28	29
20	21	22	23	24											
25	26	27	28	29											
49.7046-*	SLB4-F6,3/N-X	1000 V, CAT III/32 A 600 V, CAT IV/32 A	扁平连接片 6.3 mm × 0.8 mm	Ni c US	<table border="1"> <tr><td>20</td><td>21</td><td>22</td><td>23</td><td>24</td></tr> <tr><td>25</td><td>26</td><td>27</td><td>28</td><td>29</td></tr> </table>	20	21	22	23	24	25	26	27	28	29
20	21	22	23	24											
25	26	27	28	29											

零件

23.6999-*	BI-SLB4-F	金属件SLB4-F不带螺母	
49.7031-*	BI-SLB4-F/N	金属件SLB4-F/N-X不带螺母	
23.7222-*	BI-SLB4-F6,3	金属件SLB4-F6,3不带螺母	
23.3040-*	BI-SLB4-F6,3N	金属件SLB4-F6,3/N-X不带螺母	
23.5120	MUR/M12x0,75	圆形螺母, 适用于 SLB4-F; SLB4-F/N-X; SLB4-F6,3; SLB4-F6,3/N-X	第123页
23.5108	SSP4	垫圈, 适用于 SLB4-F; SLB4-F6,3	第123页



安装说明 MA165

www.staubli.com/electrical



平面连接插座 FSH4,8x0,8, 第125页

管状扳手 SS2, SS425, 第126页



可选颜色 30

更多信息, 第6页

面板安装插座 SLB4-...

绝缘型硬质插座, Ø 4 mm, 黄铜。可与带硬质绝缘套管的弹簧式 Ø 4 mm 插头连接。绝缘材

料UL94V-0。插座螺纹安装于塑料或金属等材质预打孔面板。

连接方式: 焊接。

SLB4-E/A-X



SLB4-E

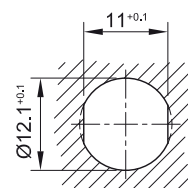
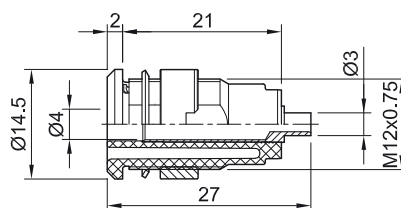

SLB4-R



SLB4-R/N-X

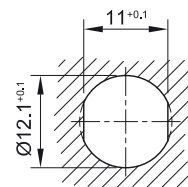
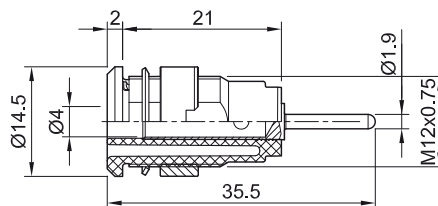

订货号	型号	额定电压/额定电流	连接方式		*标准颜色										
66.7050-*	SLB4-E/A-X	1000 V, CAT III/24 A 600 V, CAT IV/24 A	焊接	Au c US	<table border="1"><tr><td>20</td><td>21</td><td>22</td><td>23</td><td>24</td></tr><tr><td>25</td><td>26</td><td>27</td><td>28</td><td>29</td></tr></table>	20	21	22	23	24	25	26	27	28	29
20	21	22	23	24											
25	26	27	28	29											
49.7049-*	SLB4-E	1000 V, CAT III/24 A 600 V, CAT IV/24 A	焊接	Ni c US	<table border="1"><tr><td>20</td><td>21</td><td>22</td><td>23</td><td>24</td></tr><tr><td>25</td><td>26</td><td>27</td><td>28</td><td>29</td></tr></table>	20	21	22	23	24	25	26	27	28	29
20	21	22	23	24											
25	26	27	28	29											
23.3010-*	SLB4-R	1000 V, CAT III/24 A 600 V, CAT IV/24 A	圆形针 Ø 1.9 mm	Au c US	<table border="1"><tr><td>20</td><td>21</td><td>22</td><td>23</td><td>24</td></tr><tr><td>25</td><td>26</td><td>27</td><td>28</td><td>29</td></tr></table>	20	21	22	23	24	25	26	27	28	29
20	21	22	23	24											
25	26	27	28	29											
49.7048-*	SLB4-R/N-X	1000 V, CAT III/24 A 600 V, CAT IV/24 A	圆形针 Ø 1.9 mm	Ni c US	<table border="1"><tr><td>20</td><td>21</td><td>22</td><td>23</td><td>24</td></tr><tr><td>25</td><td>26</td><td>27</td><td>28</td><td>29</td></tr></table>	20	21	22	23	24	25	26	27	28	29
20	21	22	23	24											
25	26	27	28	29											

零件

66.7084-*	BI-SLB4-E/A-X	金属件SLB4-E/A-X不带螺母	
49.7083-*	BI-SLB4-E	金属件SLB4-E不带螺母	
23.7000-*	BI-SLB4-R	金属件SLB4-R不带螺母	
23.5049-*	BI-SLB4-R/N	金属件SLB4-R/N-X不带螺母	
23.5120	MUR/M12x0,75	圆形螺母, 适用于 SLB4-E; SLB4-R; SLB4-R/N-X	第123页
23.5108	SSP4	垫圈, 适用于 SLB4-R	第123页



安装说明 MA165

www.staubli.com/electrical



可选颜色 30

更多信息, 第6页



管状扳手 SS2, SS425, 第126页

面板安装插座 SLB4-G...

绝缘型硬质插座, \varnothing 4 mm, 黄铜。可与带硬质绝缘套管的弹簧式 \varnothing 4 mm 插头连接。绝缘材

料UL94V-0。插座螺纹安装于塑料或金属等材质预打孔面板。

连接方式: M4螺栓和焊接孔

SLB4-G



SLB4-G/N-X

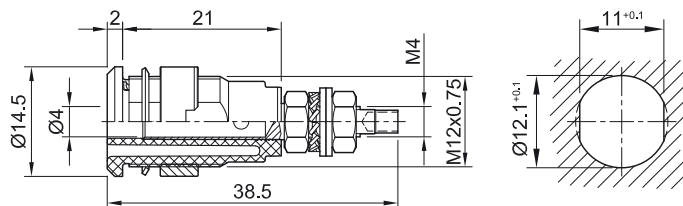

SLB4-GK



SLB4-GK/N

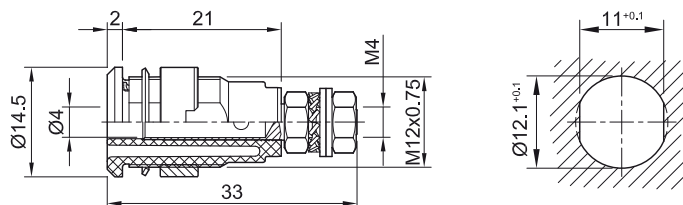

订货号	型号	额定电压/额定电流	连接方式		*标准颜色										
23.3020-*	SLB4-G	1000 V, CAT III/32 A 600 V, CAT IV/32 A	M4螺栓和焊接孔	Au US	<table border="1"><tr><td>20</td><td>21</td><td>22</td><td>23</td><td>24</td></tr><tr><td>25</td><td>26</td><td>27</td><td>28</td><td>29</td></tr></table>	20	21	22	23	24	25	26	27	28	29
20	21	22	23	24											
25	26	27	28	29											
49.7043-*	SLB4-G/N-X	1000 V, CAT III/32 A 600 V, CAT IV/32 A	M4螺栓和焊接孔	Ni US	<table border="1"><tr><td>20</td><td>21</td><td>22</td><td>23</td><td>24</td></tr><tr><td>25</td><td>26</td><td>27</td><td>28</td><td>29</td></tr></table>	20	21	22	23	24	25	26	27	28	29
20	21	22	23	24											
25	26	27	28	29											
66.3020-*	SLB4-GK	1000 V, CAT III/32 A 600 V, CAT IV/32 A	M4螺栓	Au US	<table border="1"><tr><td>20</td><td>21</td><td>22</td><td>23</td><td>24</td></tr><tr><td>25</td><td>26</td><td>27</td><td>28</td><td>29</td></tr></table>	20	21	22	23	24	25	26	27	28	29
20	21	22	23	24											
25	26	27	28	29											
66.7043-*	SLB4-GK/N	1000 V, CAT III/32 A 600 V, CAT IV/32 A	M4螺栓	Ni US	<table border="1"><tr><td>20</td><td>21</td><td>22</td><td>23</td><td>24</td></tr><tr><td>25</td><td>26</td><td>27</td><td>28</td><td>29</td></tr></table>	20	21	22	23	24	25	26	27	28	29
20	21	22	23	24											
25	26	27	28	29											

零件

23.7111-*	BI-SLB4-G	金属件SLB4-G不带螺母		
49.7034-*	BI-SLB4-G/N	金属件SLB4-G/N-X不带螺母		
66.7111-*	BI-SLB4-GK	金属件SLB4-GK不带螺母		
66.7034-*	BI-SLB4-GK/N	金属件SLB4-GK/N不带螺母		
23.5120	MUR/M12x0,75	圆形螺母, 适用于	SLB4-G; SLB4-G/N-X; SLB4-GK; SLB4-GK/N	第123页
23.5108	SSP4	垫圈, 适用于	SLB4-G; SLB4-GK	第123页
22.6509	MU0,8D/M4	2个六角螺母, 适用于	SLB4-G; SLB4-GK	第122页
22.6539	MU0,8D/M4N	2个六角螺母, 适用于	SLB4-G/N-X; SLB4-GK/N	第122页
22.6511	U/M4	2垫圈, 适用于	SLB4-G; SLB4-GK	第123页
22.6533	FS/M4	弹簧垫圈, 适用于	SLB4-G; SLB4-GK	第124页



安装说明 MA165

www.staubli.com/electrical



可选颜色 30

更多信息, 第6页



管状扳手 SS2, SS425, 第126页

直角式插座 XELW-4

直角式 $\varnothing 4$ mm插座, 黄铜, 可与带硬质绝缘套管的弹簧式 $\varnothing 4$ mm 插头连接, 符合IEC/EN 61010-1规定, 并带触摸保护。插座可以直接

焊接在PCB板上, 其直角的结构可将因测试导线插入而产生的对PCB板的应力减小到最低。

连接方式: $\varnothing 2$ mm圆针焊接于PCB板上

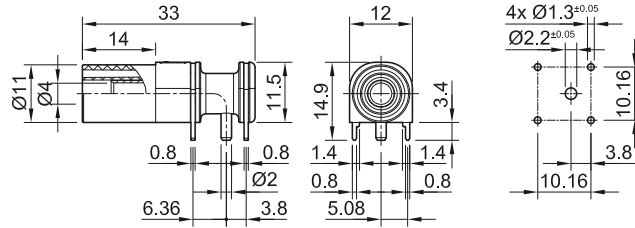

订货号	型号	额定电压/额定电流		*标准颜色
66.9040-*	XELW-4	1000 V, CAT III/24 A 600 V, CAT IV/24 A	Au c  US	21 22 23



安装说明 MAH561

www.staubli.com/electrical



可选颜色 24 25

更多信息, 第6页

面板安装插座 XEB-1R

绝缘型硬质插座, \varnothing 4 mm, 黄铜。可与带硬质绝缘套管的弹簧式 \varnothing 4 mm 插头连接。插座包含两个绝缘的半圆型金属导体, 当插头对接时导通, 可用作开关功能。插座螺

纹安装于塑料或金属等材质预打孔面板。
连接方式: 2 × 扁平连接片 4.8 mm × 0.8 mm

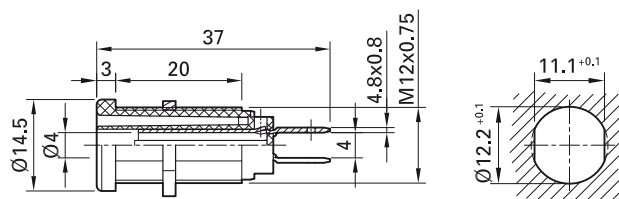

订货号	型号	额定电压/额定电流	连接方式		*标准颜色										
66.9131-*	XEB-1R	1000 V, CAT IV/20 A	2 × 扁平连接片 4.8 mm × 0.8 mm	Ni  US	<table border="1"> <tr> <td>20</td> <td>21</td> <td>22</td> <td>23</td> <td>24</td> </tr> <tr> <td>25</td> <td>26</td> <td>29</td> <td></td> <td></td> </tr> </table>	20	21	22	23	24	25	26	29		
20	21	22	23	24											
25	26	29													

可提供的安装材料

66.9679	GEW.12-MUTTER	六角螺母	第122页
---------	---------------	------	-------



平面连接插座 FSH4,8x0,8, 第125页
 管状扳手 SS2, 第126页



安装说明 MAH506

www.staubli.com/electrical

面板安装插座 XEF-1R

绝缘型硬质插座, Ø 4 mm, 黄铜。可与带硬质绝缘套管的弹簧式 Ø 4 mm 插头连接。插座螺纹安装于塑料或金属等材质预打孔面板。

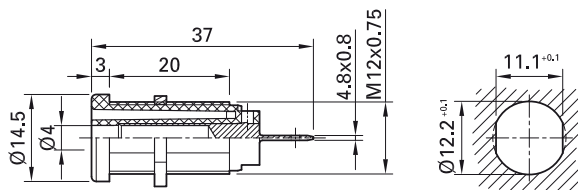

订货号	型号	额定电压/额定电流	连接方式		*标准颜色										
66.9665-*	XEF-1R	1000 V, CAT IV/24 A	扁平连接片 4.8 mm × 0.8 mm	Ni C US	<table border="1"> <tr> <td>20</td> <td>21</td> <td>22</td> <td>23</td> <td>24</td> </tr> <tr> <td>25</td> <td>26</td> <td></td> <td></td> <td></td> </tr> </table>	20	21	22	23	24	25	26			
20	21	22	23	24											
25	26														

可提供的安装材料

66.9679	GEW.12-MUTTER	六角螺母	第122页
---------	---------------	------	-------



安装说明 MAH506

www.staubli.com/electrical



管状扳手 SS2, SS425, 第126页

短接插头

短接插头 KS4-1...

带绝缘, \varnothing 4 mm, 黄铜, 采用弹簧MULTILAM \varnothing 4 mm插头连接。
 技术, 抗振性能好, 适合应用于自动化领域如
 驱动器测试和维修。绝缘体内装有 \varnothing 4 mm
 硬质插座可与带硬质绝缘套管的弹簧式

KS4-11L/1A/N



KS4-11L/1A/A

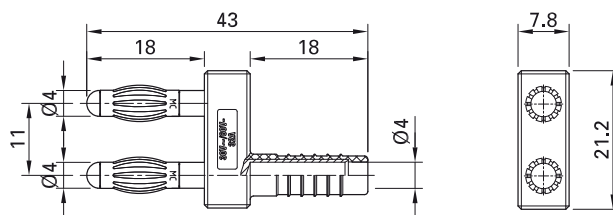

KS4-14LA/N



KS4-14LA/A

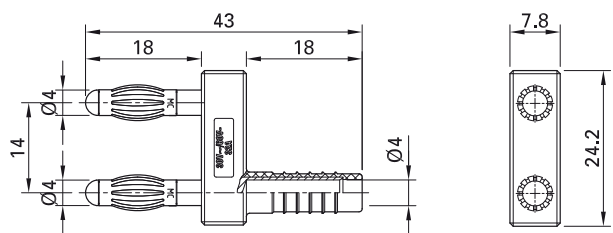

订货号	型号	额定电压/额定电流	插头间距		标准颜色
64.9302-21	KS4-11L/1A/N	AC 30 V/32 A DC 60 V/32 A	11 mm	Ni	21
64.9301-21	KS4-11L/1A/A	AC 30 V/32 A DC 60 V/32 A	11 mm	Au	21
20.1010-21	KS4-14LA/N	AC 30 V/32 A DC 60 V/32 A	14 mm	Ni	21
20.1020-21	KS4-14LA/A	AC 30 V/32 A DC 60 V/32 A	14 mm	Au	21

短接插头 KS4-1...

带绝缘, Ø 4 mm空心插头。冷拉铜合金。KS4-14短接插头尾部带Ø 4 mm硬质插座,可与插头连接。

KS4-14

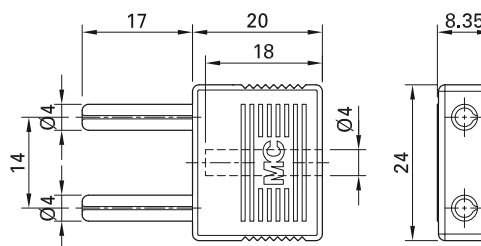

KS4-19

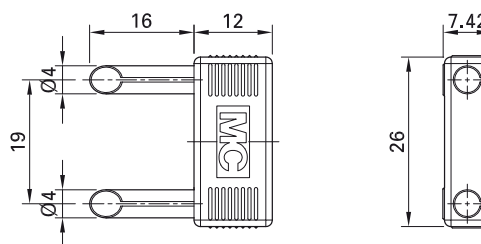

订货号	型号	额定电压/额定电流	插头间距	标准颜色
24.0004-28	KS4-14	AC 30 V/24 A DC 60 V/24 A	14 mm	Au 28
24.0002-21	KS4-19	AC 30 V/24 A DC 60 V/24 A	19 mm	Au 21



用户信息 **i097**

www.staubli.com/electrical

短接插头

短接插头 K...4N-19

绝缘, Ø 4 mm, 黄铜材质。插头采用弹簧式的 MULTILAM 技术。带绝缘手柄。可选择尾部带或不带两个直插式 Ø 4 mm 硬质插座, 可与弹簧式 Ø 4 mm 插头连接。

KS-4N-19

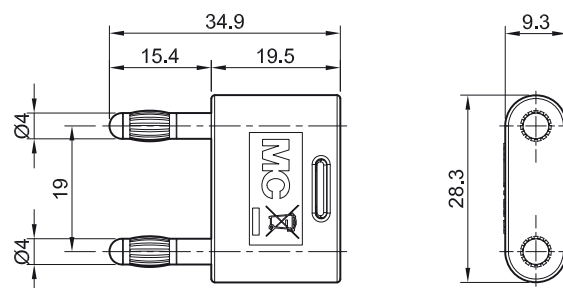

KS2-4N-19

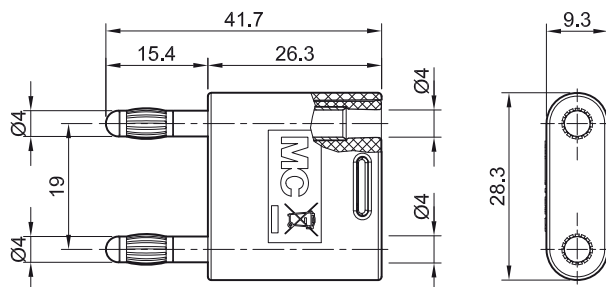

订货号	型号	额定电压/额定电流	插头间距		*标准颜色															
64.4012-*	KS-4N-19	AC 30 V/32 A DC 60 V/32 A	19 mm	Ni	<table border="1"> <tr> <td>20</td><td>21</td><td>22</td><td>23</td><td>24</td> </tr> <tr> <td>25</td><td>26</td><td>27</td><td>28</td><td>29</td> </tr> <tr> <td>30</td><td></td><td></td><td></td><td></td> </tr> </table>	20	21	22	23	24	25	26	27	28	29	30				
20	21	22	23	24																
25	26	27	28	29																
30																				
64.4010-*	KS2-4N-19	AC 30 V/32 A DC 60 V/32 A	19 mm	Ni	<table border="1"> <tr> <td>20</td><td>21</td><td>22</td><td>23</td><td>24</td> </tr> <tr> <td>25</td><td>26</td><td>27</td><td>28</td><td>29</td> </tr> <tr> <td>30</td><td></td><td></td><td></td><td></td> </tr> </table>	20	21	22	23	24	25	26	27	28	29	30				
20	21	22	23	24																
25	26	27	28	29																
30																				



用户信息 **i099**

www.staubli.com/electrical

短接插头 SK...4N-19

绝缘, Ø 4 mm, 黄铜材质。插头采用弹簧式的 MULTILAM 技术, 带硬质绝缘套管。带绝缘手柄。可选择尾部带或不带直插式 Ø 4 mm 硬质

插座, 可与带硬质绝缘套管的弹簧式 Ø 4 mm 插头连接。

SKS-4N-19

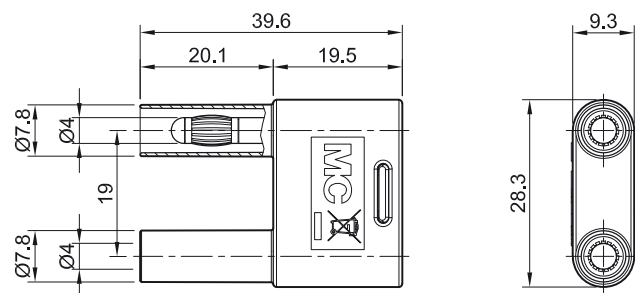

SKS2-4N-19

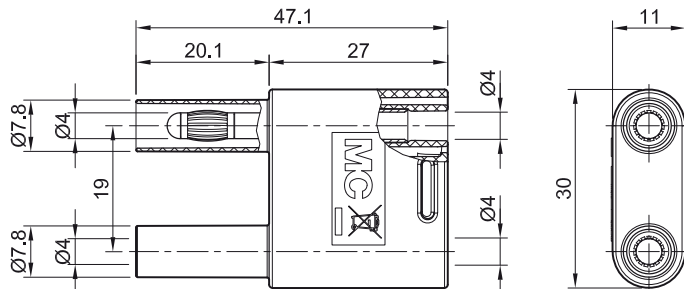

订货号	型号	额定电压/额定电流	插头间距		*标准颜色															
66.4012-*	SKS-4N-19	1000 V, CAT II/32 A	19 mm	Ni CE UK CA c UL US	<table border="1"> <tr> <td>20</td><td>21</td><td>22</td><td>23</td><td>24</td> </tr> <tr> <td>25</td><td>26</td><td>27</td><td>28</td><td>29</td> </tr> <tr> <td>30</td><td></td><td></td><td></td><td></td> </tr> </table>	20	21	22	23	24	25	26	27	28	29	30				
20	21	22	23	24																
25	26	27	28	29																
30																				
66.4010-*	SKS2-4N-19	1000 V, CAT II/32 A	19 mm	Ni CE UK CA c UL US	<table border="1"> <tr> <td>20</td><td>21</td><td>22</td><td>23</td><td>24</td> </tr> <tr> <td>25</td><td>26</td><td>27</td><td>28</td><td>29</td> </tr> <tr> <td>30</td><td></td><td></td><td></td><td></td> </tr> </table>	20	21	22	23	24	25	26	27	28	29	30				
20	21	22	23	24																
25	26	27	28	29																
30																				

测试探头

测试探头 SPP4-S/F

弹簧式不锈钢硬质针头可轻压回弹，特别适用于敏感印刷电路。手柄两端进行倒角处理。把手处的 $\varnothing 4$ mm 硬质插座，可与带硬

质绝缘套管的弹簧式 $\varnothing 4$ mm 插头连接。配有保护帽。

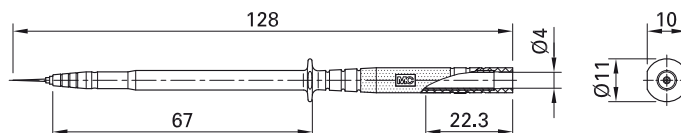

订货号	型号	额定电压/额定电流		*标准颜色
24.0238-*	SPP4-S/F	1000 V, CAT II/1 A	CE UK CA	21 22

测试探头 PP-115/4

$\varnothing 4$ mm 探头，采用弹簧MULTILAM技术，把手一侧采用扁平式处理，可以防止在使用时滚动，并允许探头紧靠着并排插入。绝缘体内装

有 $\varnothing 4$ mm 硬质插座，可与带硬质绝缘套管的弹簧式 $\varnothing 4$ mm 插头连接。配有保护帽。

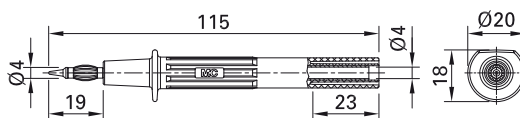

订货号	型号	额定电压/额定电流		*标准颜色
66.9112-*	PP-115/4	1000 V, CAT II/32 A	CE UK CA cUL US	21 22 23 24



可选颜色 25

更多信息, 第6页

带测试导线的测试探头XP...-484

PVC或硅胶绝缘的高柔软测试导线，一端为 $\varnothing 4$ mm测试探头，装有弹簧MULTILAM；另一端为带硬质绝缘套管的直角式 $\varnothing 4$ mm MULTILAM插头。配有保护帽。

XPF-484

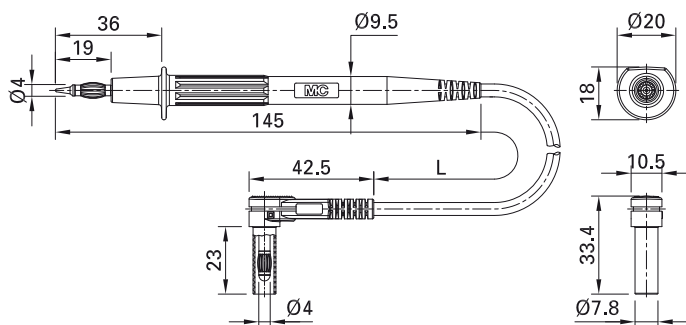

订货号	型号	额定电压/额定电流	导线		导线长度 L [cm]	*标准颜色
66.9008-□*	XPF-484	1000 V, CAT II/20 A	PVC 1.0 mm ²	Ni CE UK CA cUL US	100 150	21 22 23
66.9007-□*	XPS-484	1000 V, CAT II/20 A	SIL 1.0 mm ²	Ni CE UK CA cUL US	100 150	21 22



可选颜色 **23**
 可选长度请洽询
 更多信息, 第6页



插入式附件 XDK-1033P,
 如下

附件

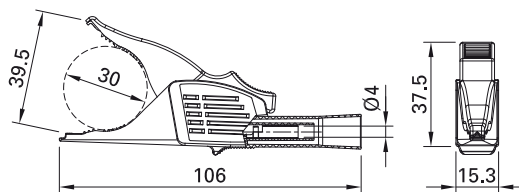

通体绝缘的海豚夹，黄铜材质。锯齿状下颌可以夹取细电线。

备注：
 长款海豚夹为上述带 $\varnothing 4$ mm探头的 XPF-484 和 XPS-484 测试导线专用。

订货号	型号	额定电压/额定电流		*标准颜色
66.9521-*	XDK-1033P	1000 V, CAT II/19 A	Ni CE UK CA cUL US	21 22

测试探头 SPP4-S

带硬质锥形不锈钢针头的测试探头,手柄两端进行倒角处理。把手处的 $\varnothing 4$ mm 硬质插座,

可与带硬质绝缘套管的弹簧式 $\varnothing 4$ mm 插头连接。配有保护帽。

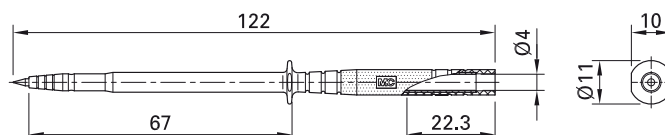

订货号	型号	额定电压/额定电流		*标准颜色
24.0235-*	SPP4-S	1000 V, CAT III/1 A	CE	21 22

测试探头 BT400

前端携带 $\varnothing 2$ mm 不锈钢材质的触子,绝缘体内装有 $\varnothing 4$ mm 硬质插座,可与带硬质绝缘套管的弹簧式 $\varnothing 4$ mm 插头连接。

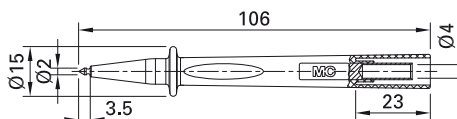

订货号	型号	额定电压/额定电流		*标准颜色
66.9390-*	BT400	1000 V, CAT IV/1 A	CE UK CA C UL US	21 22 23



可选颜色 27 28

更多信息, 第6页

测试夹

测试夹 APK-4

带绝缘, 带 $\varnothing 4$ mm硬质插座, 黄铜。尖嘴形, 带锋利锯齿, 上颌绝缘。

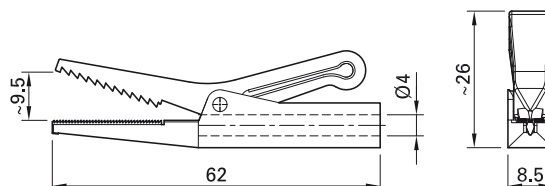

订货号	型号	额定电压/额定电流		*标准颜色
64.9209-*	APK-4	AC 30 V/10 A DC 60 V/10 A	Ni	21 22 23 24 25 26



用户信息 **i093**

www.staubli.com/electrical

鳄鱼夹 SAGK4-K

带通体绝缘的细小型黄铜制鳄鱼夹。锯齿状下颌可以夹取带 $\varnothing 4$ mm硬质插座细电线。绝缘

体内装有 $\varnothing 4$ mm硬质插座, 可与带硬质绝缘套管的弹簧式 $\varnothing 4$ mm 插头连接。

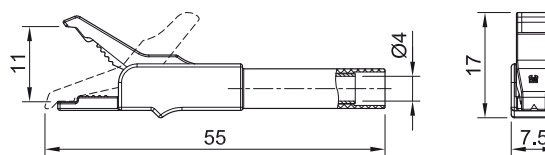

订货号	型号	额定电压/额定电流		*标准颜色
24.0157-*	SAGK4-K	300 V, CAT II/15 A	Ni CE UK CA	21 22 23

扁平测试夹 GRIP-F

用于在电压测量中进行快速、安全连接的扁平测试夹，测试夹开口可调节。把手处的

Ø 4 mm 硬质插座，可与带硬质绝缘套管的弹簧式 Ø 4 mm 插头连接。

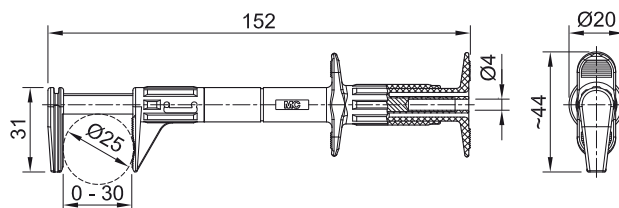

订货号	型号	额定电压/额定电流		*标准颜色
66.9829-*	GRIP-F	600 V, CAT III/5 A	Ni CE UK CA C UL US	21 22 23 24 25 26



可选颜色 **20**

更多信息, 第6页

测试夹 SKPS-4

带柔性杆和不锈钢弹簧电线夹的测试夹, 适合与插针或不易接触处的电线连接。尤其适合测量电压。杆体带硅胶绝缘, 即使在极端寒冷的情况下也能保证良好的耐热性和柔软性。把

手处的 $\varnothing 4$ mm 硬质插座, 可与带硬质绝缘套管的弹簧式 $\varnothing 4$ mm 插头连接。

SKPS-4

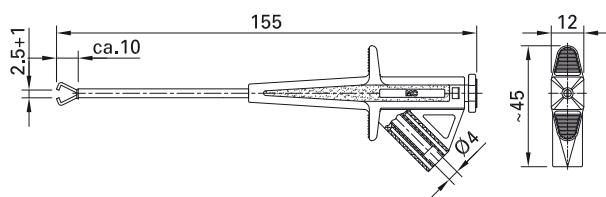

SKPS-4_100

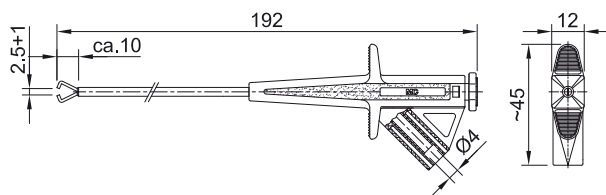

订货号	型号	额定电压/额定电流		*标准颜色
24.0224-*	SKPS-4	1000 V, CAT II/4 A	CE UK CA c UL US	21 22 23 24 25
24.0227-*	SKPS-4_100	1000 V, CAT II/4 A	CE UK CA c UL US	21 22 23 24 25



可选颜色 [26](#)

更多信息, 第6页

鳄鱼夹 XKK-1001

带通体绝缘保护的鳄鱼夹, 黄铜。锯齿状下颌可以夹取细电线。绝缘体内装有 $\varnothing 4$ mm 硬质

插座, 可与带硬质绝缘套管的弹簧式 $\varnothing 4$ mm 插头连接。

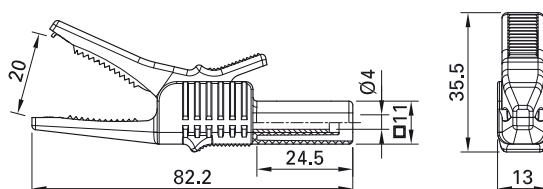

订货号	型号	额定电压/额定电流		*标准颜色										
66.9755-*	XKK-1001	1000 V, CAT II/32 A	Ni CE UK CA C UL US	<table border="1"> <tr> <td>20</td> <td>21</td> <td>22</td> <td>23</td> <td>24</td> </tr> <tr> <td>25</td> <td>26</td> <td>27</td> <td>28</td> <td>29</td> </tr> </table>	20	21	22	23	24	25	26	27	28	29
20	21	22	23	24										
25	26	27	28	29										

测试夹 GRIP-A

带硬质挂钩夹, 钢制, 可以用来钩住电缆。把手处的 $\varnothing 4$ mm 硬质插座, 可与带硬质绝缘套管

的弹簧式 $\varnothing 4$ mm 插头连接。

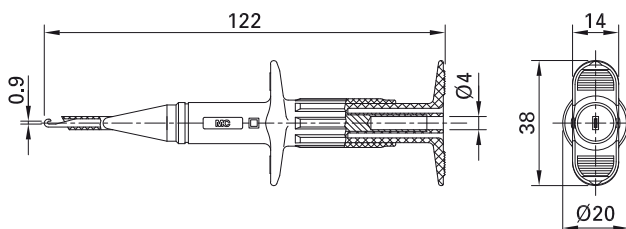

订货号	型号	额定电压/额定电流		*标准颜色			
66.9116-*	GRIP-A	1000 V, CAT III/3 A	CE UK CA C UL US	<table border="1"> <tr> <td>21</td> <td>22</td> <td>23</td> </tr> </table>	21	22	23
21	22	23					



可选颜色 24 25 26

更多信息, 第6页

测试夹 GRIP-DI

带钢制下颚的测试夹，特别适用于连接接地柱和大电缆。为了提高连接时的安全性，下颚有绝缘保护外层。把手处的 $\varnothing 4$ mm 硬质插座，可与带硬质绝缘套管的弹簧式 $\varnothing 4$ mm 插头连接。带有透明保险丝套筒，可安装大小

为 10 mm x 38 mm 的大功率保险丝。
保险丝需另购。

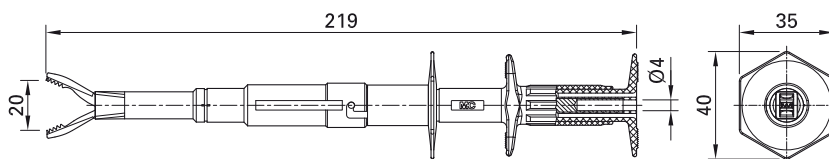

订货号	型号	额定电压/额定电流		*标准颜色
66.9266-*	GRIP-DI	1000 V, CAT III/max. 16 A ¹⁾	Ni CE UK CA C UL ²⁾ us	21 22

¹⁾ 取决于使用的保险丝。

²⁾ 仅在使用符合UL认证的保险丝时适用。



可选颜色 23 24 25 26

更多信息, 第6页



高熔断保险丝, 第128页



用户信息 i068

www.staubli.com/electrical

海豚夹 XDK-1033/I-2

海豚夹通体绝缘，上颚使用绝缘是为了防止夹子开口时由于误接触而出现意外短路。海豚夹上部安装有柔软的TPE内嵌，这种设计还可以提升夹子的附着力。

此类绝缘可用于CATIV的测量类别。

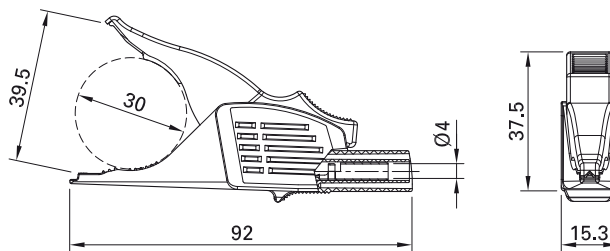

订货号	型号	额定电压/额定电流		*标准颜色										
66.9561-*	XDK-1033/I-2	1000 V, CAT III/19 A 600 V, CAT IV/19 A	Ni CE UK CA C UL US	<table border="1"> <tr> <td>20</td> <td>21</td> <td>22</td> <td>23</td> <td>24</td> </tr> <tr> <td>25</td> <td>26</td> <td>27</td> <td>29</td> <td></td> </tr> </table>	20	21	22	23	24	25	26	27	29	
20	21	22	23	24										
25	26	27	29											



可选颜色 ²⁸

更多信息, 第6页

海豚夹 XDK-1033

带通体绝缘保护的海豚夹，黄铜。锯齿状下颌可以夹取细电线。绝缘体内装有 Ø 4 mm 硬质

插座，可与带硬质绝缘套管的弹簧式 Ø 4 mm 插头连接。

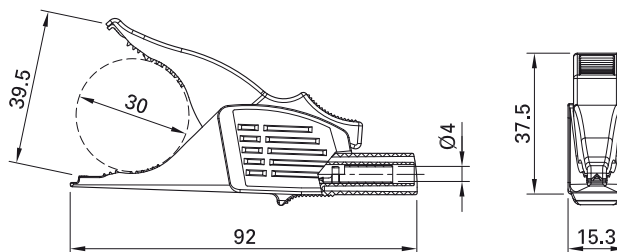

订货号	型号	额定电压/额定电流		*标准颜色										
66.9575-*	XDK-1033	1000 V, CAT III/32 A	Ni CE UK CA C UL US	<table border="1"> <tr> <td>20</td> <td>21</td> <td>22</td> <td>23</td> <td>24</td> </tr> <tr> <td>25</td> <td>26</td> <td>27</td> <td>29</td> <td></td> </tr> </table>	20	21	22	23	24	25	26	27	29	
20	21	22	23	24										
25	26	27	29											



可选颜色 ²⁸

更多信息, 第6页

测试夹 AB200

带钢制下颚的测试夹，特别适用于连接接地柱和大电缆。为了提高连接时的安全性，下颚有绝缘保护外层。把手处的 Ø 4 mm 硬质插

座，可与带硬质绝缘套管的弹簧式 Ø 4 mm 插头连接。

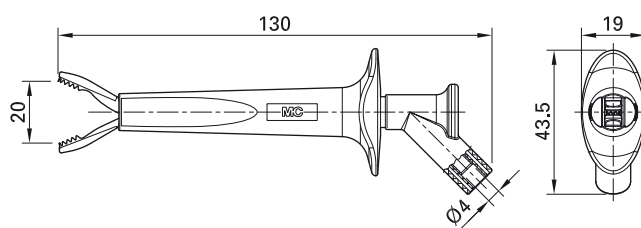

订货号	型号	额定电压/额定电流		*标准颜色										
66.9474-*	AB200	1000 V, CAT IV/16 A	Ni CE UK CA C UL US	<table border="1"> <tr> <td>20</td> <td>21</td> <td>22</td> <td>23</td> <td>24</td> </tr> <tr> <td>25</td> <td>26</td> <td></td> <td></td> <td></td> </tr> </table>	20	21	22	23	24	25	26			
20	21	22	23	24										
25	26													



可选颜色 27 28 29

更多信息, 第6页

扁平测试夹 GRIP-FMA

用于快速、安全地连接汇流排，比如，备用发电机的同步。通过我们久经考验的 MULTILAM，在汇流排前后两面建立起可靠的连接。把手

处的 Ø 4 mm 硬质插座，可与带硬质绝缘套管的弹簧式 Ø 4 mm 插头连接。

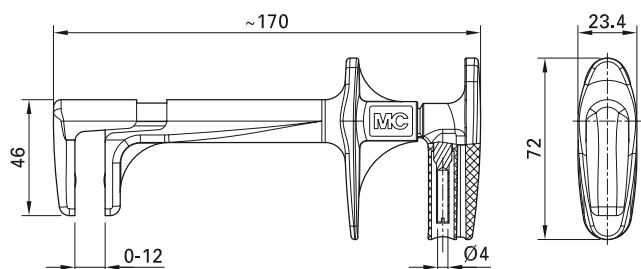

订货号	型号	额定电压/额定电流		标准颜色
66.9435-21	GRIP-FMA	1000 V, CAT IV/32 A	CE UK CA	21

螺纹钳 GRIP-ESZ...

螺纹钳用于快速安全地与M4, M5或M6螺纹螺栓连接, 比如: 电动机连接(接触深度3至6 mm)。压力握柄部分装有 \varnothing 4 mm固定插座, 可与带硬质绝缘套管的弹簧式

\varnothing 4 mm插头配合使用。该产品还有配有测试导线的版本。
电流取决于螺纹嵌件。

GRIP-ESZ...

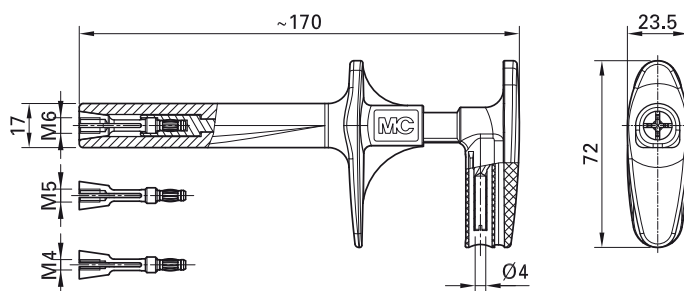

订货号	型号	额定电压/额定电流	内嵌钳子	螺纹	导线长度 L [cm]		标准颜色
66.9446-21	GRIP-ESZ4	1000 V, CAT IV / 20 A	Z4	M4	-	CE UK CB	21
66.9447-21	GRIP-ESZ5	1000 V, CAT IV / 30 A	Z5	M5	-	CE UK CB	21
66.9448-21	GRIP-ESZ6	1000 V, CAT IV / 32 A	Z6	M6	-	CE UK CB	21



用户信息 **i112**

www.staubli.com/electrical

适配器

减径适配器 R4/2

无绝缘, Ø 4 mm, 黄铜, 采用弹簧MULTILAM技术。把手处的 Ø 2 mm 硬质插座, 可与带硬

质绝缘套管的弹簧式 Ø 2 mm 插头连接 (两端均可插入)。

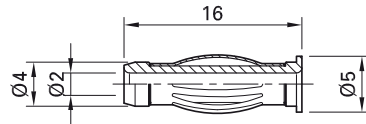

订货号	型号	额定电压/额定电流		
24.0110	R4/2	AC 30 V/25 A DC 60 V/25 A	Au	



用户信息 **i097**

www.staubli.com/electrical

减径适配器 R4/2-A

绝缘, Ø 4 mm, 黄铜, 采用弹簧MULTILAM技术。绝缘体内装有 Ø2mm 硬质插座, 可与带硬质绝缘套管的弹簧式 Ø2mm 插头连接。

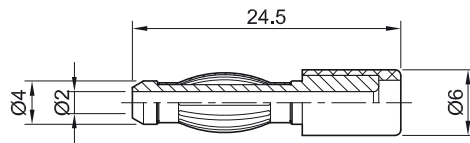

订货号	型号	额定电压/额定电流		*标准颜色
24.0106-*	R4/2-A	AC 30 V/25 A DC 60 V/25 A	Au	21 22 23



可选颜色 **24**

更多信息, 第6页



用户信息 **i097**

www.staubli.com/electrical

插头适配器 A4/4-Z

Ø 4 mm 插头, 黄铜, 采用弹簧MULTILAM技术, 带伸缩套管可防止意外触摸。绝缘体内装有 Ø 4 mm 硬质插座, 可与带硬质绝缘套管的

的弹簧式 Ø 4 mm 插头连接。

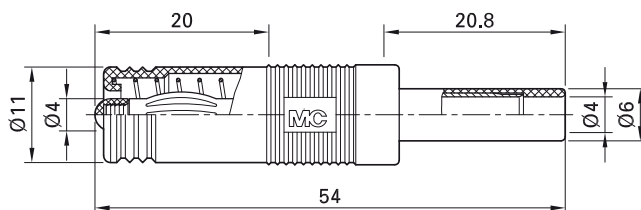

订货号	型号	额定电压/额定电流		标准颜色
24.0116-22	A4/4-Z	AC 30 V/25 A DC 60 V/25 A	Ni	22



用户信息 **i097**

www.staubli.com/electrical

插头适配器 LS410-I

Ø 4 mm 插头, 黄铜, 采用弹簧MULTILAM技术。绝缘体内装有 Ø 4 mm 硬质插座, 可与带

硬质绝缘套管的弹簧式 Ø 4 mm 插头连接。

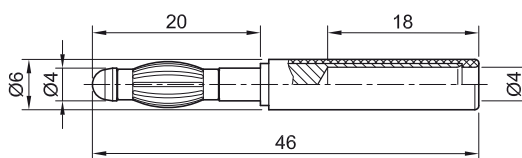

订货号	型号	额定电压/额定电流		*标准颜色
22.5163-*	LS410-I	AC 30 V/30 A DC 60 V/30 A	Ni	21 22



用户信息 **i098**

www.staubli.com/electrical

螺纹连接适配器 B4-E-M5-I

带绝缘和M5外螺纹,可与螺纹孔连接。黄铜。
绝缘体内装有 $\varnothing 4$ mm 硬质插座,可与带硬质绝缘套管的弹簧式 $\varnothing 4$ mm 插头连接。插座带内槽,可使用螺丝刀。

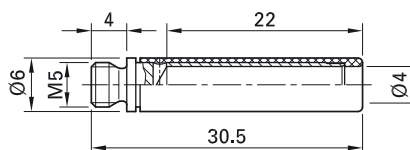

订货号	型号	额定电压/额定电流	螺纹		*标准颜色
23.1034-*	B4-E-M5-I	AC 30 V/30 A DC 60 V/30 A	M5	Ni	21 22 23 24



用户信息 **i098**

www.staubli.com/electrical

测试插头 PS2,3

$\varnothing 2.3$ mm 插头,镀银黄铜,采用弹簧 MULTILAM 技术。可安装于 M3 螺纹孔。绝缘体

内装有 $\varnothing 4$ mm 硬质插座,可与带硬质绝缘套管的弹簧式 $\varnothing 4$ mm 插头连接。

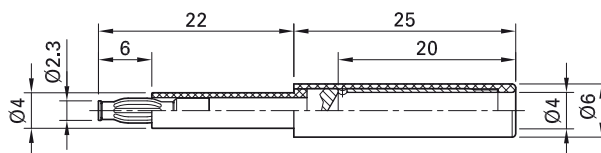

订货号	型号	额定电压/额定电流		*标准颜色
24.0100-*	PS2,3	AC 30 V/25 A DC 60 V/25 A	Ag	21 22



用户信息 **i097**

www.staubli.com/electrical

测试插头 A-SLK4-RG

Ø 4 mm, 黄铜, 采用弹簧MULTILAM技术。
可顺序连接于 Ø 4 mm 插座。绝缘体内装有

Ø 4 mm 硬质插座, 可与带硬质绝缘套管的弹
簧式 Ø 4 mm 插头连接。

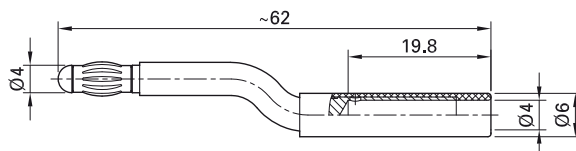

订货号	型号	额定电压/额定电流		标准颜色
24.0164-21	A-SLK4-RG	AC 30 V/25 A DC 60 V/25 A	Ni	21



用户信息 **i097**

www.staubli.com/electrical

螺纹连接适配器 B4-E-M...

带绝缘和螺栓, 可与螺纹孔进行连接。黄铜。绝
缘体内装有 Ø 4 mm 硬质插座, 可与带硬质绝

缘套管的弹簧式 Ø 4 mm 插头连接。插座带内
槽, 可使用螺丝刀。

B4-E-M3-I

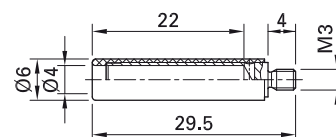

B4-E-M4-I

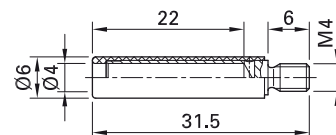

订货号	型号	额定电压/额定电流	螺纹		*标准颜色
23.1031-*	B4-E-M3-I	600 V, CAT II/32 A	M3	Ni	21 22 23 24
23.1033-*	B4-E-M4-I	600 V, CAT II/32 A	M4	Ni	21 22 23 24



用户信息 **i119**

www.staubli.com/electrical

螺纹连接适配器 LB4-G/M4

带绝缘和螺栓, 可与螺纹孔进行连接。黄铜。绝缘体内装有 $\varnothing 4$ mm 硬质插座, 可与带硬质绝缘套管的弹簧式 $\varnothing 4$ mm 插头连接。

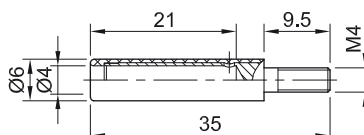

订货号	型号	额定电压/额定电流	螺纹		*标准颜色
23.0280-*	LB4-G/M4	600 V, CAT II/32 A	M4	Ni	21 22



用户信息 **i119**

www.staubli.com/electrical



可选颜色 23 24

更多信息, 第6页

螺纹连接适配器 B4-E-IM4-I

带绝缘和M4螺纹孔, 可与M4螺栓连接。黄铜。绝缘体内装有 $\varnothing 4$ mm 硬质插座, 可与带硬质绝缘套管的弹簧式 $\varnothing 4$ mm 插头连接。插座带内槽, 可使用螺丝刀。

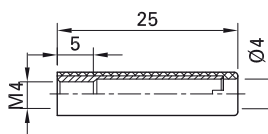

订货号	型号	额定电压/额定电流		*标准颜色
23.1035-*	B4-E-IM4-I	600 V, CAT II/32 A	Ni	21 22 23 24



用户信息 **i119**

www.staubli.com/electrical

带圆形黄铜插针的适配器 ZPS-20/25

硬质, 非常适合与电能表的夹子进行螺纹连接。绝缘体内装有 $\varnothing 4$ mm 硬质插座, 可与带硬质绝缘套管的弹簧式 $\varnothing 4$ mm 插头连接。

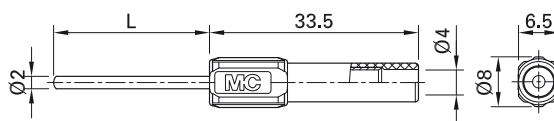

订货号	型号	额定电压/额定电流	长度 (L)		*标准颜色										
66.9076-*	ZPS-20/25	600 V, CAT II/19 A	25 mm	Ni	<table border="1"> <tr> <td>21</td> <td>22</td> <td>23</td> <td>24</td> <td>25</td> </tr> <tr> <td>26</td> <td>27</td> <td></td> <td></td> <td></td> </tr> </table>	21	22	23	24	25	26	27			
21	22	23	24	25											
26	27														



用户信息 i004

www.staubli.com/electrical

适配器导线 XLAM-SLK-4N...

带屏蔽、高柔软适配器导线。一端为同轴电缆，
装有带触摸保护的BNC公头，另一端为带硬质

绝缘套管的直插式 Ø 4 mm MULTILAM插头。

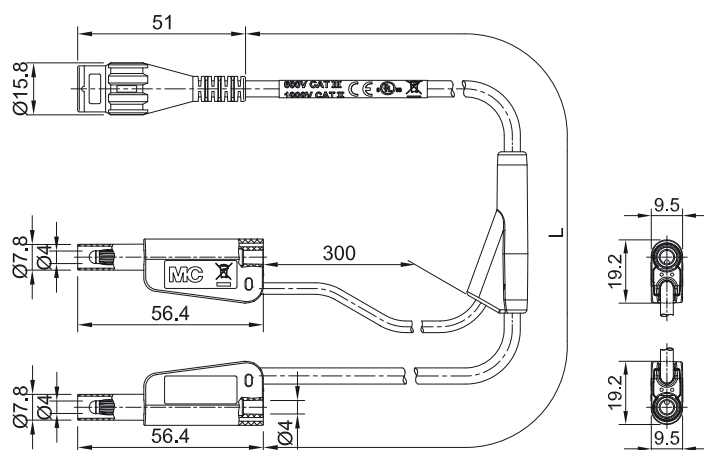

订货号	型号	额定电压	导线		导线长度 L [cm]
66.1030-□	XLAM-SLK-4N-RG58	1000 V, CAT II 600 V, CAT III	PVC RG58	Au Ni CE UK CA c UL US	100 160
66.1031-□	XLAM-SLK-4N-SILI-SC05	1000 V, CAT II 600 V, CAT III	SIL SILI-SC 0,5/1,0	Au Ni CE UK CA c UL US	100 160



可选长度请洽询
更多信息, 第6页



用户信息 **i014**

www.staubli.com/electrical

适配器导线 XLAM-SAK-4N...

带屏蔽、高柔软适配器导线。一端为同轴电缆，装有带触摸保护的BNC公头，另一端为带硬质绝缘套管的直插式 Ø 4 mm MULTILAM插头。

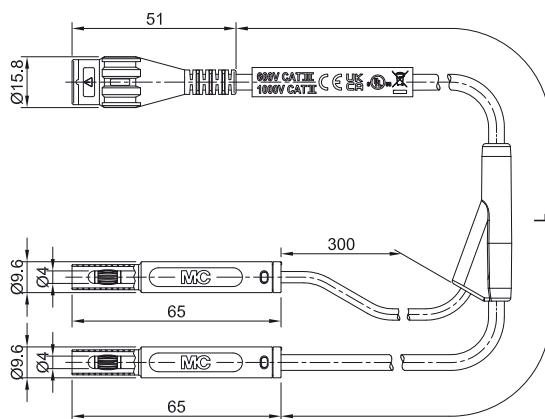

订货号	型号	额定电压	导线		导线长度 L [cm]
66.1051-□	XLAM-SAK-4N-RG58	1000 V, CAT II 600 V, CAT III	PVC RG58	Au Ni CE UK CA c UL US	100 160
66.1052-□	XLAM-SAK-4N-SILI-SC05	1000 V, CAT II 600 V, CAT III	sIL SILI-SC 0,5/1,0	Au Ni CE UK CA c UL US	100 160



可选长度请咨询
更多信息, 第 6 页



用户信息 **i014**

www.staubli.com/electrical

导线联结器 XHK

带绝缘, 黄铜, 两端均可对接带硬质绝缘套管的弹簧式 Ø 4 mm 插头。

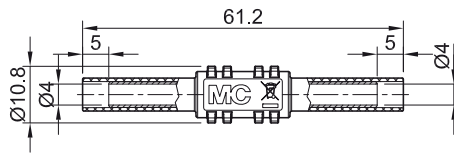

订货号	型号	额定电压/额定电流		*标准颜色
66.9123-*	XHK	1000 V, CAT II/32 A	Ni CE UK CA c UL US	21 22 23 24 25



用户信息 i006

www.staubli.com/electrical



可选颜色 26 27 29

更多信息, 第6页

直角插头适配器 XWA-4/19

带绝缘, 黄铜, 一端为带硬质绝缘套管的 Ø 4 mm 弹簧MULTILAM插头; 另一端 Ø 4 mm 硬质插座, 可与带硬质绝缘套管的弹簧式 Ø 4 mm 插头连接。此款适配器特别适用

于带前面板插座的仪器, 用户使用测试导线时会更加方便。

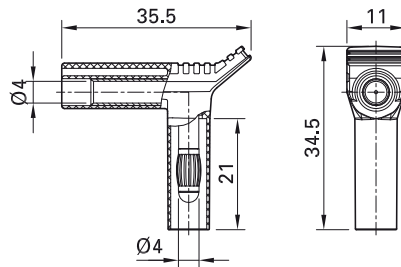

订货号	型号	额定电压/额定电流		*标准颜色
66.9694-*	XWA-4/19	1000 V, CAT II/20 A 600 V, CAT III/20 A	Ni CE UK CA	21 22 23



可选颜色 24 25 26 27 29

更多信息, 第6页

带圆形黄铜插针的适配器 B4-I/S1,5

硬质, 非常适合与电能表的夹子进行螺纹连接。可90°弯曲, 且只可以弯曲一次。绝缘体内

装有 Ø 4 mm 硬质插座, 可与带硬质绝缘套管的弹簧式 Ø 4 mm 插头连接。

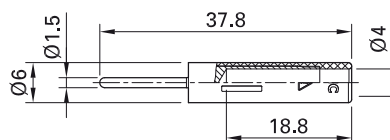

订货号	型号	额定电压/额定电流		*标准颜色
23.0240-*	B4-I/S1,5	1000 V, CAT II/20 A	Ni	21 22 23 24



用户信息 **i011**

www.staubli.com/electrical



可选颜色 **25**

更多信息, 第6页

螺纹压接适配器 A-SLK4...

带绝缘、黄铜,可螺纹安装于 $\varnothing 4$ mm插座。此款适配器带扩展型 $\varnothing 4$ mm螺纹插头,可通过螺丝直接安装于插座中。在连接状态下提供完

全的触摸保护,绝缘体内装有 $\varnothing 4$ mm硬质插座,可与带硬质绝缘套管的弹簧式 $\varnothing 4$ mm插头连接。

A-SLK4-S

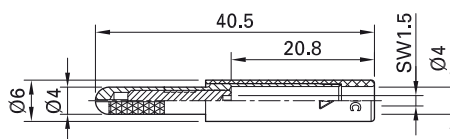

A-SLK4

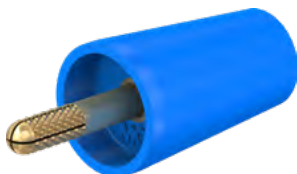

A-SLK4-N

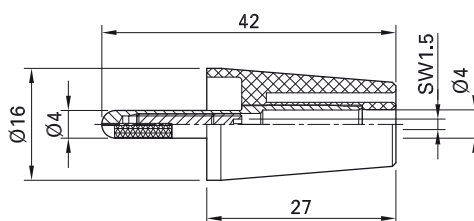

订货号	型号	额定电压/额定电流	用户信息		*标准颜色
24.0163-*	A-SLK4-S	1000 V, CAT II/25 A	i009	Ni	21 22 23 24
24.0160-*	A-SLK4	1000 V, CAT II/32 A	i010	Au	20 21 22 23 24 25 26 27 28 29
24.0161-*	A-SLK4-N	1000 V, CAT II/32 A	i010	Ni	20 21 22 23 24 25 26 27 28 29



可选颜色 25 29

更多信息, 第6页



六角扳手 STS1,5 第122页



用户信息 i009, i010

www.staubli.com/electrical



安装说明 MA115

www.staubli.com/electrical

固定连接适配器 B4-I/KS

黄铜材质, 用于固定连接。比如: 用于连接螺纹接线柱。绝缘体内装有 Ø 4 mm 硬质插座, 可

与带硬质绝缘套管的弹簧式 Ø 4 mm 插头连接。叉形接线片可90°弯曲, 但仅能弯曲一次。

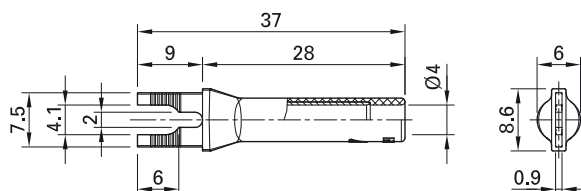
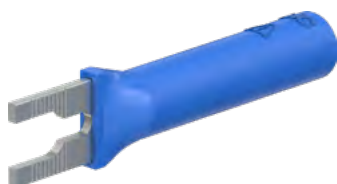

订货号	型号	额定电压/额定电流		*标准颜色
23.0480-*	B4-I/KS	1000 V, CAT II/20 A	Ni	21 22 23 24



用户信息 **i011**

www.staubli.com/electrical

固定连接适配器 B4-I/KA

黄铜材质, 用于固定连接。比如: 用于连接螺纹接线柱。绝缘体内装有 Ø 4 mm 硬质插座, 可

与带硬质绝缘套管的弹簧式 Ø 4 mm 插头连接。叉形接线片带45°弯曲。

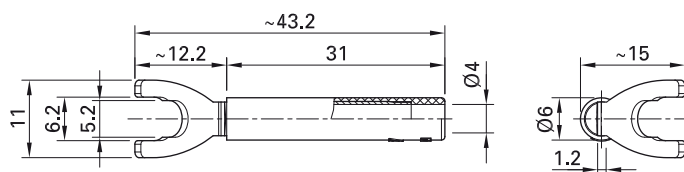

订货号	型号	额定电压/额定电流		*标准颜色
23.0440-*	B4-I/KA	1000 V, CAT II/20 A	Au	21 22 23 24



用户信息 **i011**

www.staubli.com/electrical

固定连接适配器 B4-I/K

黄铜材质, 用于固定连接。比如: 用于连接螺纹接线柱。绝缘体内装有 $\varnothing 4$ mm 硬质插座,

可与带硬质绝缘套管的弹簧式 $\varnothing 4$ mm 插头连接。

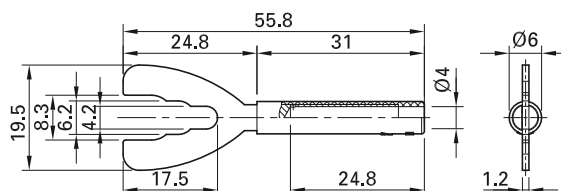

订货号	型号	额定电压/额定电流		*标准颜色
23.5065-*	B4-I/K	1000 V, CAT II/32 A	Au	21 22 23



用户信息 **i010**

www.staubli.com/electrical



可选颜色 **24**

更多信息, 第6页

螺纹连接适配器 A-SLK4-RS

带绝缘和M3.5外螺纹。可顺序连接于M3.5螺纹孔。黄铜。绝缘体内装有 Ø 4 mm 硬质插座，可与带硬质绝缘套管的弹簧式 Ø 4 mm 插头连接。插座带内槽，可使用螺丝刀。

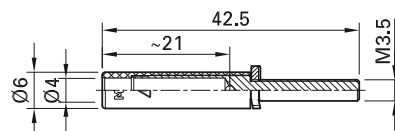

订货号	型号	额定电压/额定电流		*标准颜色
24.0168-*	A-SLK4-RS	1000 V, CAT II/25 A	Ni	21 22 23 24



可选颜色 25 26 29

更多信息, 第6页



用户信息 i009

www.staubli.com/electrical

适配器 A-SLK4-R

带绝缘的柔性铜丝, 适用于多种螺纹压接形式。比如: 顺序(串联)。绝缘体内装有 Ø 4 mm 硬质插座, 黄铜材质, 可与带硬质绝缘套管的弹簧式 Ø 4 mm 插头连接。

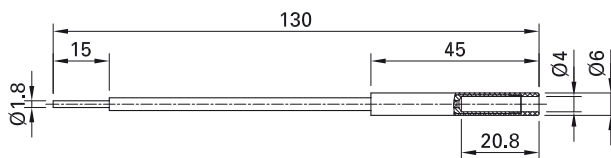

订货号	型号	额定电压/额定电流		*标准颜色
24.0162-*	A-SLK4-R	1000 V, CAT II/32 A	Ni	21 22 23 24 25 26 27 29



用户信息 i010

www.staubli.com/electrical



可选颜色 28

更多信息, 第6页

BNC适配器 X.../4

带触摸保护的两极适配器,用于 $\varnothing 4\text{ mm}$ 连接器与 BNC系统的连接。有BNC公/母连接器,以及 $\varnothing 4\text{ mm}$ 硬质插座或带硬质绝缘套

管的 $\varnothing 4\text{ mm}$ MULTILAM插头等多种规格可选。BNC插入式连接器内部导体的金属件的材质为镀金黄铜。

XM-BB/4

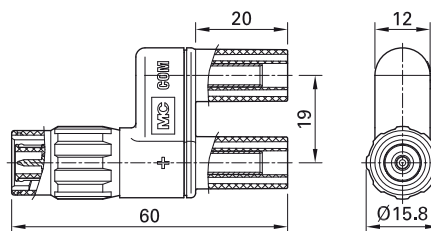

XF-BB/4

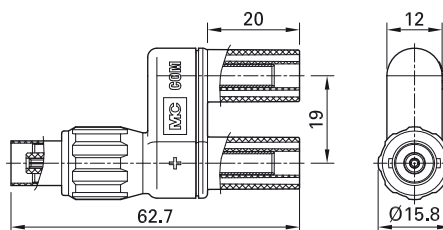

XF-SS/4

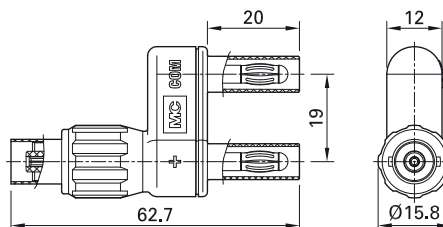

订货号	型号	额定电压	BNC连接器	$\varnothing 4\text{ mm}$ 连接器		标准颜色
67.9536-21	XM-BB/4	1000 V, CAT II 600 V, CAT III	BNC公头	$\varnothing 4\text{ mm}$ 插座	Au Ni CE UK CA c UL US	21
67.9538-21	XF-BB/4	1000 V, CAT II 600 V, CAT III	BNC母头	$\varnothing 4\text{ mm}$ 插座	Au Ni CE UK CA c UL US	21
67.9537-21	XF-SS/4	1000 V, CAT II 600 V, CAT III	BNC母头	$\varnothing 4\text{ mm}$ 插头	Au Ni CE UK CA c UL US	21

磁性连接适配器 XMA-...

用于连接螺丝或者螺栓。绝缘体内装有
 $\varnothing 4$ mm 硬质插座, 可与带硬质绝缘套管的弹
 簧式 $\varnothing 4$ mm 插头连接。

XMA-7

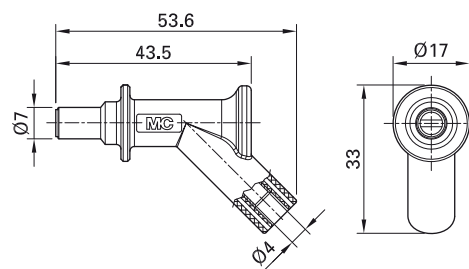

XMA-7L

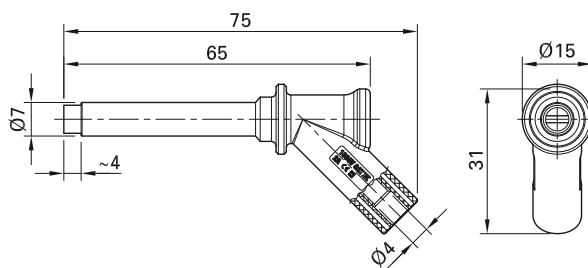
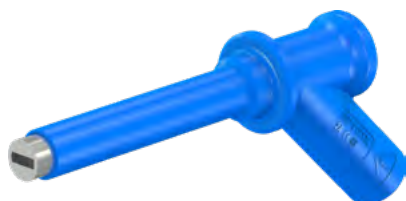

XMA-11

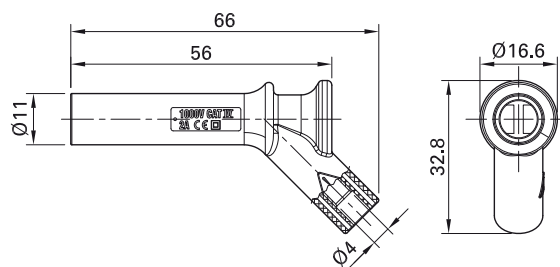

订货号	型号	额定电压/额定电流	磁体直径		*标准颜色
66.9516-*	XMA-7	1000 V, CAT III/2 A 600 V, CAT IV/2 A	$\varnothing 7$ mm	Ni	21 22 23
66.9509-*	XMA-7L	1000 V, CAT IV/2 A	$\varnothing 7$ mm	Ni	21 22 23
66.9515-*	XMA-11	1000 V, CAT IV/2 A	$\varnothing 11$ mm	Ni	21 22 23



用户信息 **i500**

www.staubli.com/electrical

开尔文测试导线

开尔文测试导线 KELVIN-SADK-4N-SILI-SC10

一端是开尔文海豚夹，外部全部绝缘，通过牢固的衔铁和细电线能很好的适应不同尺寸的被测物体。另一端是带硬质绝缘套管的

Ø 4 mm MULTILAM插头。导线采用硅胶绝缘同轴电缆，具有非常好的柔软性。

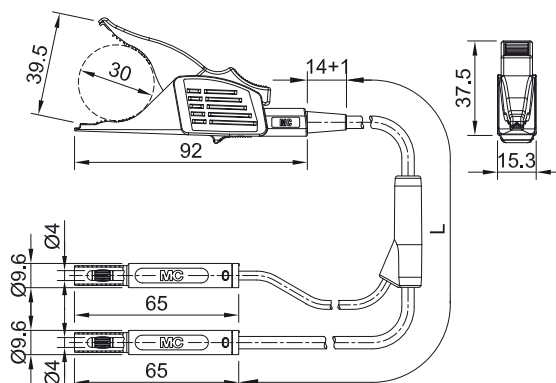

订货号	型号	额定电压/额定电流	导线		导线长度 L [cm]
66.8012-*	KELVIN-SADK-4N-SILI-SC10	1000 V, CAT II/20 A	SIL 2 x 1.0 mm ²	Ni CE UK CA	250



可选长度请咨询
更多信息, 第 6 页



用户信息 **i143**

www.staubli.com/electrical

特殊测试附件： 用于电压高达5 kV的绝缘测试设备

测试导线 SAK-4N-T05-5KV

高柔软测试导线，两端均为带硬质绝缘套管的直插式 Ø 4 mm MULTILAM 插头。

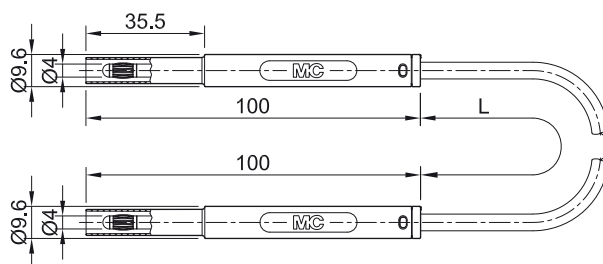

订货号	型号	额定电压/额定电流	导线		导线长度 L [cm]	*标准颜色
66.8010-150□*	SAK-4N-T05-5KV	1000 V, CAT IV/10 A 5 kV ¹⁾	TPE 0.5 mm ²	Ni CE UK CA	150	21 22 23



用户信息 **i079**

www.staubli.com/electrical



可选长度请咨询
更多信息，第 6 页

测试导线 SAPK-4N-T05-5KV

高柔软测试导线一端带 Ø 4 mm 弹簧 MULTILAM 测试探头，另一端是带硬质绝缘套管的直插式 Ø 4 mm MULTILAM 插头。配有保护帽。

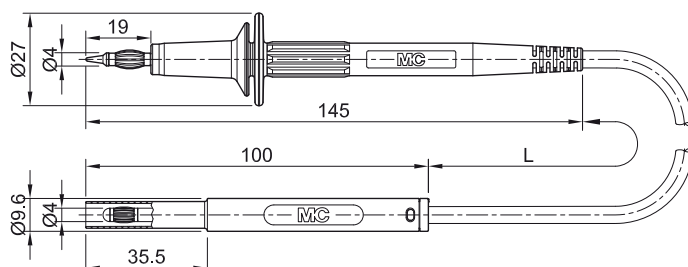

订货号	型号	额定电压/额定电流	导线		导线长度 L [cm]	*标准颜色
66.8011-150□*	SAPK-4N-T05-5KV	1000 V, CAT II/10 A 5 kV ¹⁾	TPE 0.5 mm ²	Ni CE UK CA	150	21 22 23

¹⁾ 测量仪输出电压，如 绝缘测试仪。



用户信息 **i109**

www.staubli.com/electrical



可选长度请咨询
更多信息，第 6 页

插座 XHB-5000

硬质, 绝缘, \varnothing 4 mm 高压插座。可对接 ZHM-5000 和 XHL-5000 测试导线。出于安全考虑, 此插座与我们产品系列的 \varnothing 4 mm 插头不兼容。

连接方式: 扁平连接片 4.8 mm x 0.8 mm

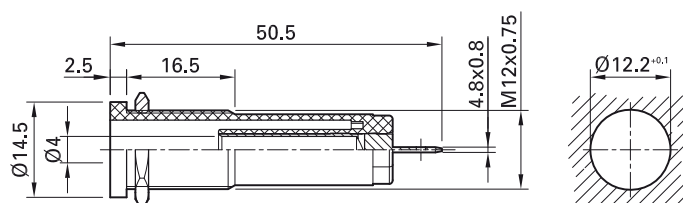

订货号	型号	额定电压/额定电流		*标准颜色
66.9427-*	XHB-5000	1000 V, CAT IV/10 A 5 kV ¹⁾	Au	21 22 23

¹⁾ 测量仪输出电压, 如 绝缘测试仪。



用户信息 **i109**

www.staubli.com/electrical

装配部件和附件

装配部件和附件

六角螺母 MU.../M...GEW.12-MUTTER

适用于我们的面板安装插座和端子。

MU0,5D/M4N



MU0,8D/M4 MU0,8D/M4N



MU/M5



MU/M6x0,5



MUE/M6x0,75



MU/M8x0,5



MU/M12x0,75



GEW.12-MUTTER

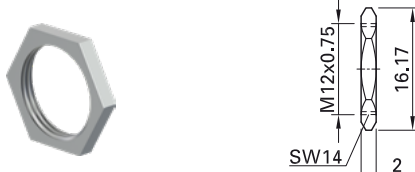

订货号	型号	扳手尺寸	螺纹	
22.6610	MU0,5D/M4N	SW7	M4	Ni
22.6509	MU0,8D/M4	SW7	M4	Au
22.6539	MU0,8D/M4N	SW7	M4	Ni
23.5103	MU/M5	SW6	M5	Ni
23.5104	MU/M6x0,5	SW8	M6x0.5	Ni
50.2008	MUE/M6x0,75	SW8	M6x0.75	Ni
23.5112	MU/M8x0,5	SW10	M8x0.5	Ni
23.5118	MU/M12x0,75	SW15	M12x0.75	Ni
66.9679	GEW.12-MUTTER	SW14	Gew.12	Ni

圆形螺母 MUR...

适用于我们的面板安装插座和端子。

MUR/M6x0,5

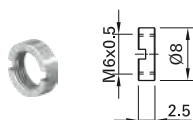

MUR/M8x0,5

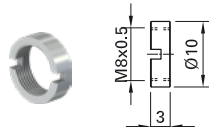

MUR/M12x0,75

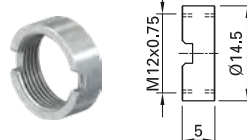

MUR-S/M12x0,75

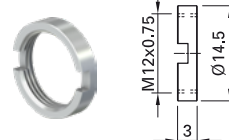

订货号	型号	扳手尺寸	螺纹	
23.5100	MUR/M6x0,5	SS2	M6x0.5	Ni
23.5110	MUR/M8x0,5	SS4	M8x0.5	Ni
23.5120	MUR/M12x0,75	SS425	M12x0.75	Ni
23.5116	MUR-S/M12x0,75	SS425	M12x0.75	Ni

垫圈 SP2 U/M4 U/4,3x12 SSP4 SP4

SP2

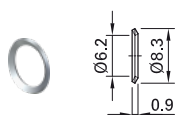

U/M4

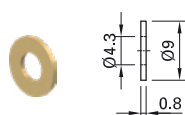

U/4,3x12

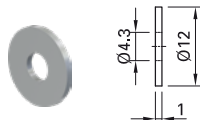

SSP4

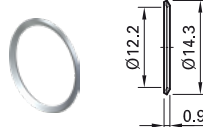

SP4

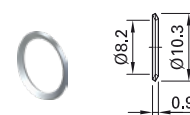

订货号	型号	
23.5105	SP2	Ni
22.6511	U/M4	Au
22.6516	U/4,3x12	Sn
23.5108	SSP4	Ni
23.5107	SP4	Ni

弹簧垫圈 FS/M...

FS/M4

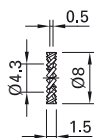

FS/M12

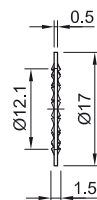

订货号	型号	
22.6533	FS/M4	
23.5117	FS/M12	Ni

保护帽 SCHUDE-SLB

遮盖不插电、不使用的插座。

SCHUDE-SLB

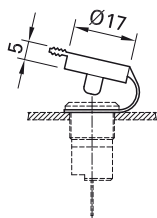

订货号	型号	适用的插座类型	防护等级	标准颜色
23.5140-*	SCHUDE-SLB	SEB4..., SLB4..., XE...-1R	IP65	21 33

安全罩 SCHUKA-SLB

用于遮盖插座连接件, 实现触摸保护。

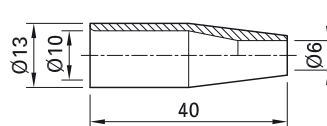

订货号	型号	适用的插座类型	标准颜色
23.5142-33	SCHUKA-SLB	SEB4..., SLB4..., XE...-1R(R)	33

平面连接插座 FSH4,8x0,8

符合EN 61210的镀金平面连接插座适用于带扁平连接片的插座。

FSH4,8x0,8



订货号	型号	适用于扁平连接片	可连接的导体截面	
23.5201	FSH4,8x0,8	4.8 mm × 0.8 mm	0.5 mm ² ... 1.0 mm ²	Au

管状扳手 SS...

特殊扳手用于拧紧和拧出圆形螺母, 或用于触摸保护插座的防扭曲扳手。

SS2



SS425



订货号	型号	适合圆形螺母/插座
25.0022	SS2	XEB-..., SLB4-..., SAB4-...
25.0020	SS425	MUR/M12x0,75, MUR-S/M12x0,75
25.0023	SS2-S	SLB2-...
25.0021	SS4	MUR/M8x0,5

六角扳手 STS1,5

无绝缘的六角扳手 (边长1.5mm)



订货号	型号	版本
25.0035	STS1,5	无绝缘

压入工具 MB...

钢制安装芯棒, 适用于我们压入式插座。

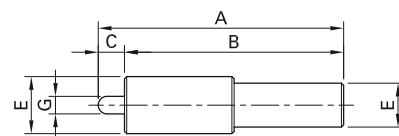
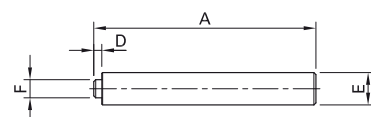
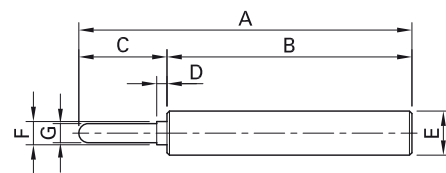
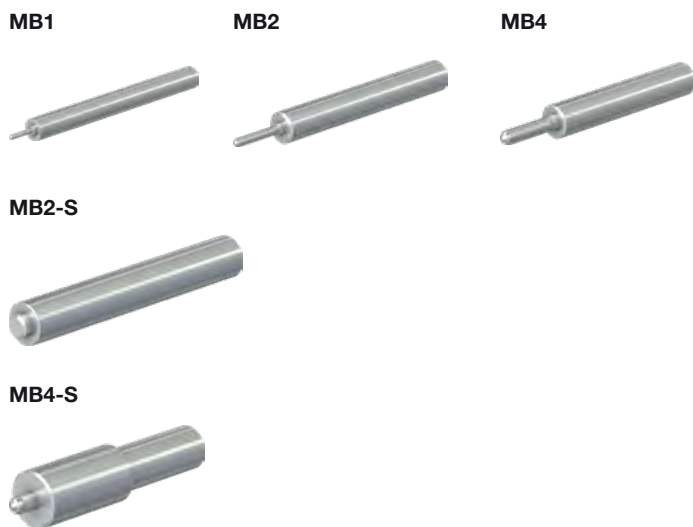

订货号	型号	适用的插座类型	(mm)						
			A	B	C	D	E	F	G
25.0030	MB1	EB1	56.9	50	6.9	0.9	Ø 5	Ø 2.4	Ø 1
25.0031	MB2	LB2, EPB-2N/S, EB2, EB2-A	63.5	50	13.5	1.6	Ø 7	Ø 3	Ø 1.9
25.0032	MB4	EB4-...	68	50	18	2.1	Ø 9	Ø 4.75	Ø 3.9
25.0028	MB2-S	SEB2-...	55	53	-	2	Ø 8	Ø 4.5	-
25.0033	MB4-S	XEP..., SEB4-..., XUB-G	56	50	6	-	Ø 10/13	-	Ø 4

HBC型保险丝 FLU-11 DMI...

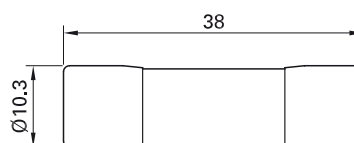

可以安全地阻断特别大的短路电流。因其特别低的内部电阻,也适用于测量电阻和电流。
符合UL认证。

FLU-11

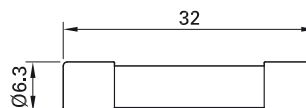

DMI-0,5A



订货号	型号	额定保险丝	保险丝尺寸	断开容量	
69.0011	FLU-11	11 A	10 x 38 mm	20 kA (AC/DC 1000 V)	
69.0012	DMI-0,5A	0.5 A	6.3 x 32 mm	30 kA (AC/DC 1000 V)	
69.0013	DMI-1,6A	1.6 A	6.3 x 32 mm	30 kA (AC/DC 1000 V)	

测试导线夹持器 LKW2-N

由方形阳极氧化铝管制成的推车，用于有序存放测试导线。带有两个长50 cm的导线夹持器，每边含34个塑料托槽。为了便于运输，产品需要自行组装。

产品不含测试导线！

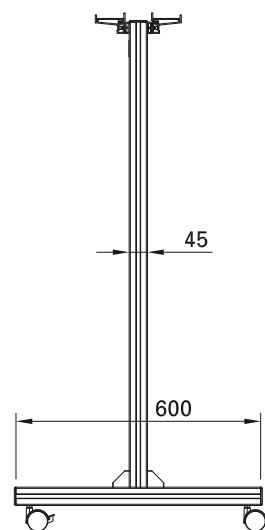
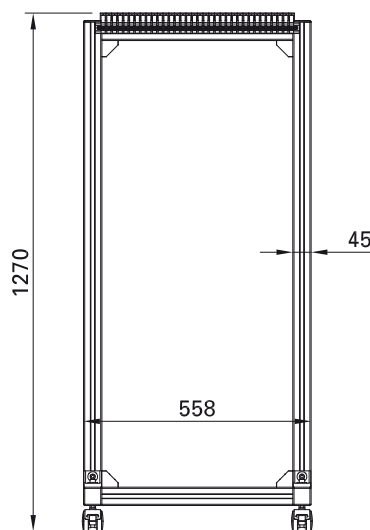

订货号	型号
64.9284	LKW2-N



安装说明 MA164

www.staubli.com/electrical

测试导线夹持器 MH-1/330

用于有序存放测试导线的夹持器。C型轨由阳极氧化铝制成，作为托槽模块MPK-10的底座，有多种长度选择(型号 MPS-...)。托槽间隔为4 mm，通过间隔凸块隔开。当需要摆放较小尺

寸的导线时，可取走凸块。当需要摆放较大尺寸导线时，可沿C型轨移动托槽增大间距。

MH-1/330



订货号	型号	长度	托槽数量
64.9244-033	MH-1/330	33 cm	21

零件

64.9235	MPK-10	托槽模块
---------	--------	------

附件 索引

按型号分类

型号	页
A2/4	35
A4/4-Z	104
AB-4A-F10	40
AB200	101
ACR10-4A-39	52
ACR10-4N-39	52
ACR25-4A-39	52
ACR25-4N-39	52
AF-4A2A-F05	36
AK-4A-F10	39
AK-4N-F10	39
AL-4A-39	51
AL-4N-39	51
AM-4N-46	51
APK-4	95
A-SLK4	113
A-SLK4-N	113
A-SLK4-R	116
A-SLK4-RG	106
A-SLK4-RS	116
A-SLK4-S	113
B4-E-IM4-I	107
B4-E-M3-I	106
B4-E-M4-I	106
B4-E-M5-I	105
B4-I/K	115
B4-I/KA	114
B4-I/KS	114
B4-I/S1,5	112
BCR10-4A-39	55
BCR10-4N-39	55
BCR25-4A-39	55
BCR25-4N-39	55
B-EB2	21
B-EB2-A	21
B-EB2-F	22
B-EB4_AU	68
B-EB4-B	70
B-EB4-IR_AU	69
B-EB4-IR_NI	69
BI-LB4x-IE/N	72
BI-LB4x-IF/A	73

型号	页
BI-SLB4-E	83
BI-SLB4-E/A-X	83
BI-SLB4-F	82
BI-SLB4-F6,3	82
BI-SLB4-F6,3N	82
BI-SLB4-F/A	81
BI-SLB4-F/N	82
BI-SLB4-G	84
BI-SLB4-GK	84
BI-SLB4-GK/N	84
BI-SLB4-G/N	84
BI-SLB4-R	83
BI-SLB4-R/N	83
BL2-6/20-0,65	25
BL2-6/20/A	25
BL2-12/20-0,65	25
BL2-12/20/A	25
BL-4A-39	54
BL-4N-39	54
BT400	94
DMI-0,5A	128
DMI-1,6A	128
EB1	11
EB2	21
EB2-A	21
EB2-F	22
EB4-IF/A	68
EB4-IFA/N	70
EB4-IR/A	69
EB4-IR/A_1,2	69
EB4-IR/N	69
EPB-2N/S	20
FLU-11	128
FSH4,8x0,8	125
FS/M4	71, 75, 80, 84, 124
FS/M12	71, 124
GEW.12-MUTTER	86, 87, 122
GL-438	53
GL-438-L	53
GRIP-A	98
GRIP-DI	99
GRIP-ESZ4	102

型号	页
GRIP-ESZ5	102
GRIP-ESZ6	102
GRIP-F	96
GRIP-FMA	101
I-EB2	21, 22
I-EB4-I	68, 69
I-EB4-IFA	70
KELVIN-SADK-4N-SILI-SC10	119
KLS4	56
KPS1/B2	33
KS2-4N-19	90
KS2-5,08L/1A/A	30
KS2-6L/A	29
KS2-6L/N	29
KS2-10L	31
KS2-10L/1	31
KS2-12L/1SA/A	30
KS2-12L/1SA/N	30
KS2-12L/A	29
KS2-12L/N	29
KS4-11L/1A/A	88
KS4-11L/1A/N	88
KS4-14	89
KS4-14LA/A	88
KS4-14LA/N	88
KS4-19	89
KS-4N-19	90
KT2-S	17
KT205	16
KT425-SW	57
KT-GL-438	53
KT-L-4-30	49
KT-L-4-39	49
KT-SL-4-39	61
KT-SL-4-46	61
LB2	19
LB2-A	19
LB2-D	20
LB2-IF	23
LB4	67
LB4-A	67
LB4-G/M4	107
LB4H-IE/N	72
LB4H-IF/A	73

型号	页
LB-I2R	23
LB-IF2R	24
LK1-A	9
LK2-F	13
LK-4A2A-F05	35
LK-4A-F10	38
LK-4A-F25	38
LK-4A-S10	38
LK-4A-S25	38
LK-4N-F10	38
LK-4N-F25	38
LK-4N-S10	38
LK-4N-S25	38
LK205	13
LK205-L	14
LK205-X	13
LKW2-N	129
LM-4A-30	49
LM-4A-39	49
LM-4N-30	49
LM-4N-39	49
LQ-4A-30	49
LQ-4A-39	49
LQ-4N-30	49
LQ-4N-39	49
LS2-S	17
LS205	16
LS205-L	17
LS205N	16
LS410-I	104
LS425-SW	57
LS425-SW/A	57
LS-GL-438	53
LS-GL-438-L	53
LS-SLM-4A	49, 61
LS-SLM-4N	49, 61
LS-SLQ-4A	49, 61
LS-SLQ-4N	49, 61
MB1	127
MB2	127
MB2-S	127
MB4	127
MB4-S	127
MH-1/330	130

型号	页
MicroGrip-XB	33
MPK-10	130
MSLB4-G	71
MU0,5D/M4N	71, 122
MU0,8D/M4	75, 80, 84, 122
MU0,8D/M4N	75, 80, 84, 122
MUE/M6x0,75	122
MU/M5	122
MU/M6x0,5	122
MU/M8x0,5	72, 73, 122
MU/M12x0,75	71, 122
MUR/M6x0,5	123
MUR/M8x0,5	28, 123
MUR/M12x0,75	81, 82, 83, 84, 123
MUR-S/M12x0,75	76, 123
PK2-T	26
PK4-T	74
PP-115/4	92
PS2,3	105
R4/2	103
R4/2-A	103
SAB4-F/A	76
SAB4-G	75
SAB4-G/N-X	75
SACR10-4A-39-TW	63
SACR10-4N-39-TW	63
SACR25-4A-39-TW	63
SACR25-4A-46	64
SACR25-4N-39-TW	63
SAF-4N-F10	46
SAF-4N-S10	46
SAGK4-K	95
SAK-4A-F10-TW	44
SAK-4A-F25-TW	44
SAK-4N-F10	45
SAK-4N-F10-ILF	48
SAK-4N-F10-TW	44
SAK-4N-F25	45
SAK-4N-F25-TW	44
SAK-4N-S10	45
SAK-4N-S10-ILF	48
SAK-4N-S25	45
SAK-4N-T05-5KV	120
SAL-4A-39-TW	62

型号	页
SAL-4N-39-TW	62
SAM-4N-46	64
SAPK-4N-T05-5KV	120
SARK-4N-F10	47
SARK-4N-S10	47
SASK-4N-F10	42
SBCR10-4A-39	66
SBCR10-4N-39	66
SBL-4A-39	66
SBL-4N-39	66
SBM-4N-46	65
SCHUDE-SLB	124
SCHUKA-SLB	125
SEB2-F2,8	27
SEB2-R	27
SEB4-E	79
SEB4-E/A	79
SEB4-F	78
SEB4-F6,3	78
SEB4-F6,3/N	78
SEB4-F/A	81
SEB4-F/N	78
SEB4-G	80
SEB4-GK	80
SEB4-GK/N	80
SEB4-G/N-X	80
SEB4-R	79
SEB4-R/N	79
SKLS4	58
SKPS-4	97
SKPS-4_100	97
SKS2-4N-19	91
SKS2-12L/1SA/N	32
SKS-4N-19	91
SL205-K	18
SLB2-F2,8	28
SLB2-R	28
SLB4-E	83
SLB4-E/A-X	83
SLB4-F	82
SLB4-F6,3	82
SLB4-F6,3/N-X	82
SLB4-F/A	81
SLB4-F/N-X	82

型号	页
SLB4-G	84
SLB4-GK	84
SLB4-GK/N	84
SLB4-G/N-X	84
SLB4-R	83
SLB4-R/N-X	83
SLK-4A-F10	43
SLK-4A-F25	43
SLK-4A-S10	43
SLK-4A-S25	43
SLK-4N-F10	43
SLK-4N-F25	43
SLK-4N-S10	43
SLK-4N-S25	43
SLK205-K	14
SLK205-W/L	15
SLK205-W/L/SIL	15
SLM-4A-39	61
SLM-4A-46	61
SLM-4N-39	61
SLM-4N-46	61
SLQ-4A-39	61
SLQ-4A-46	61
SLQ-4N-39	61
SLQ-4N-46	61
SLS1-B	10
SLS1-S	10
SLS2-S	17
SLS205	16
SLS205-L	17
SLS205-X	16
SLS425-SW	57
SLS425-SW/A	57
SP2	123
SP4	28, 73, 123
SPP2-S	32
SPP4-S	94
SPP4-S/F	92
SS2	126
SS2-S	126
SS4	126
SS425	126
SSP4	76, 81, 82, 83, 84, 123
STS1,5	127

型号	页
U/4,3x12	75, 123
U/M4	75, 80, 84, 123
XALF	34
XDK-1033	100
XDK-1033/I-2	100
XDK-1033P	93
XEB-1R	86
XEF-1R	87
XELW-4	85
XF-BB/4	117
XF-SS/4	117
X-GL-438	60
XHB-5000	121
XHK	111
XKK-200	34
XKK-1001	98
XLAM-SAK-4N-RG58	110
XLAM-SAK-4N-SILI-SC05	110
XLAM-SLK-4N-RG58	109
XLAM-SLK-4N-SILI-SC05	109
XMA-7	118
XMA-7L	118
XMA-11	118
XM-BB/4	117
XPF-484	93
XPS-484	93
XUB-G	77
XWA-4/19	111
XZG410	41
XZG410/SIL	41
XZG425	41
XZG425/SIL	41
XZGL-425	59
ZGL-425	50
ZPS-20/25	108

按订货号分类

订货号	页
20.1010-21	88
20.1020-21	88
22.1002	17
22.1004	16
22.1009	17
22.1042	57
22.1045	57
22.2010-*	17
22.2030-*	16
22.2370-*	57
22.2602-*	10
22.2603-*	10
22.2609-*	17
22.2616-*	16
22.2617-*	16
22.2618-*	17
22.2667-*	57
22.2668-*	57
22.3006-*	56
22.3007-*	58
22.5006	16
22.5163-*	104
22.6509	75, 80, 84, 122
22.6511	75, 80, 84, 123
22.6516	75, 123
22.6533	71, 75, 80, 84, 124
22.6539	75, 80, 84, 122
22.6610	71, 122
23.0030-*	23
23.0050-*	23
23.0060-*	24
23.0240-*	112
23.0280-*	107
23.0290-*	26
23.0330-*	74
23.0440-*	114
23.0480-*	114
23.1000	19
23.1001	19
23.1003	67
23.1004	67
23.1010-*	11

订货号	页
23.1011-*	21
23.1012-*	21
23.1021-*	22
23.1031-*	106
23.1033-*	106
23.1034-*	105
23.1035-*	107
23.3000-*	82
23.3010-*	83
23.3020-*	84
23.3030-*	81
23.3040-*	82
23.3050-*	75
23.3060-*	82
23.3070-*	81
23.3090	71
23.3110-*	76
23.3120-*	78
23.3130-*	79
23.3140-*	80
23.3150-*	78
23.3160-*	81
23.5002	21
23.5005	22
23.5010	21
23.5011-*	21, 22
23.5026	70
23.5049-*	83
23.5065-*	115
23.5100	123
23.5103	122
23.5104	122
23.5105	123
23.5107	28, 73, 123
23.5108	76, 81, 82, 83, 84, 123
23.5110	28, 123
23.5112	72, 73, 122
23.5116	76, 123
23.5117	71, 124
23.5118	71, 122
23.5120	81, 82, 83, 84, 123
23.5140-33	124

订货号	页
23.5142-33	125
23.5201	125
23.6999-*	82
23.7000-*	83
23.7111-*	84
23.7222-*	82
24.0002-21	89
24.0004-28	89
24.0042-29	31
24.0043-29	31
24.0100-*	105
24.0106-*	103
24.0110	103
24.0115-*	35
24.0116-22	104
24.0139-*	33
24.0157-*	95
24.0160-*	113
24.0161-*	113
24.0162-*	116
24.0163-*	113
24.0164-21	106
24.0168-*	116
24.0224-*	97
24.0227-*	97
24.0235-*	94
24.0238-*	92
24.0239-*	32
25.0020	126
25.0021	126
25.0022	126
25.0023	126
25.0028	127
25.0030	127
25.0031	127
25.0032	127
25.0033	127
25.0035	127
28.0026-*	9
28.0033-*	13
28.0039-*	13
28.0047-*	14
28.0115-*	13
49.7031-*	82

订货号	页
49.7034-*	84
49.7042-*	75
49.7043-*	84
49.7044-*	82
49.7046-*	82
49.7048-*	83
49.7049-*	83
49.7073-*	78
49.7079-*	78
49.7080-*	79
49.7083-*	83
49.7091-*	79
49.7092-*	80
49.7512	20
50.2008	122
63.9318-*	20
63.9352-*	29
63.9353-*	29
63.9354-*	29
63.9355-*	29
63.9356-*	25
63.9358-*	25
63.9363-*	25
63.9364-*	25
63.9845-21	30
63.9847-21	30
63.9848-21	30
64.1030-*	38
64.1031-*	38
64.1032-*	38
64.1033-*	38
64.1034-*	38
64.1035-*	38
64.1036-*	38
64.1037-*	38
64.1038-*	49
64.1039-*	49
64.1040-*	49
64.1041-*	49
64.1042-*	49
64.1043-*	49
64.1044-*	49
64.1045-*	49
64.1046-*	49

订货号	页
64.1047-*	49
64.1060-*	35
64.1070-*	39
64.1071-*	39
64.1072-*	40
64.1073-*	36
64.2010-*	53
64.2020	53
64.2030	53
64.2040-*	53
64.2050-*	51
64.2051-*	51
64.2052-*	52
64.2053-*	52
64.2054-*	52
64.2055-*	52
64.2056-*	51
64.2060-*	54
64.2061-*	54
64.2062-*	55
64.2063-*	55
64.2064-*	55
64.2065-*	55
64.3010-*	68
64.3011-*	69
64.3012-*	69
64.3013-*	70
64.3014-*	69
64.3020	68
64.3021	69
64.3022	69
64.3030-*	68, 69
64.3031-*	70
64.3040-*	73
64.3042-*	72
64.3050-*	73
64.3051	72
64.4010-*	90
64.4012-*	90
64.9209-*	95
64.9235	130
64.9244-033	130
64.9284	129
64.9301-21	88

订货号	页
64.9302-21	88
64.9326-*	50
64.9701-*	53
65.9098-*	28
65.9099-*	27
65.9179-*	14
65.9182-*	18
65.9185-*	34
65.9187-*	33
65.9188-*	34
65.9193-*	27
65.9194-*	28
65.9577-*	15
65.9578-*	15
65.9866-21	32
66.1030-	109
66.1031-	109
66.1040-*	45
66.1041-*	45
66.1042-*	45
66.1043-*	45
66.1044-*	46
66.1045-*	46
66.1046-*	48
66.1047-*	48
66.1048-*	42
66.1049-*	47
66.1050-*	47
66.1051-	110
66.1052-	110
66.1053-*	44
66.1054-*	44
66.1055-*	44
66.1056-*	44
66.2010-*	43
66.2011-*	43
66.2012-*	43
66.2013-*	43
66.2014-*	43
66.2015-*	43
66.2016-*	43
66.2017-*	43
66.2018-*	61
66.2019-*	61

订货号	页
66.2020-*	61
66.2021-*	61
66.2022-*	61
66.2023-*	61
66.2024-*	61
66.2025-*	61
66.2026-*	61
66.2027-*	61
66.2028	49, 61
66.2029	49, 61
66.2030	49, 61
66.2031	49, 61
66.2040-*	62
66.2041-*	62
66.2042-*	63
66.2043-*	63
66.2044-*	63
66.2045-*	63
66.2046-*	64
66.2047-*	64
66.2050-*	66
66.2051-*	66
66.2052-*	66
66.2053-*	66
66.2054-*	65
66.3020-*	84
66.3140-*	80
66.4010-*	91
66.4012-*	91
66.7034-*	84
66.7043-*	84
66.7049-*	80
66.7050-*	83
66.7084-*	83
66.7092-*	79
66.7111-*	84
66.8010-150*	120
66.8011-150*	120
66.8012-*	119
66.9007-*	93
66.9008-*	93
66.9040-*	85
66.9076-*	108
66.9112-*	92

订货号	页
66.9116-*	98
66.9123-*	111
66.9131-*	86
66.9266-*	99
66.9328-*	59
66.9390-*	94
66.9405-*	41
66.9406-*	41
66.9407-*	41
66.9408-*	41
66.9427-*	121
66.9435-21	101
66.9446-21	102
66.9447-21	102
66.9448-21	102
66.9474-*	101
66.9509-*	118
66.9515-*	118
66.9516-*	118
66.9521-*	93
66.9561-*	100
66.9575-*	100
66.9584-*	60
66.9665-*	87
66.9679	86, 87, 122
66.9684-*	77
66.9694-*	111
66.9755-*	98
66.9829-*	96
67.9536-21	117
67.9537-21	117
67.9538-21	117
69.0011	128
69.0012	128
69.0013	128



● 史陶比尔公司 ○ 代表处/代理商

史陶比尔集团 在全球的分布

www.staubli.com