

# International IOR Rectifier

## 10MQ100N

### SCHOTTKY RECTIFIER

### 2.1 Amp

勝特力材料 886-3-5753170  
 勝特力电子(上海) 86-21-54151736  
 勝特力电子(深圳) 86-755-83298787  
[Http://www.100y.com.tw](http://www.100y.com.tw)

$I_{F(AV)} = 2.1\text{Amp}$   
 $V_R = 100\text{V}$

#### Major Ratings and Characteristics

Characteristics	10MQ100N	Units
$I_F$ DC	2.1	A
$V_{RRM}$	100	V
$I_{FSM}$ @tp = 5 $\mu$ s sine	120	A
$V_F$ @1.5Apk, $T_J=125^\circ\text{C}$	0.68	V
$T_J$ range	-55 to 150	$^\circ\text{C}$

#### Description/ Features

The 10MQ100N surface mount Schottky rectifier has been designed for applications requiring low forward drop and very small foot prints on PC boards. Typical applications are in disk drives, switching power supplies, converters, free-wheeling diodes, battery charging, and reverse battery protection.

- Small foot print, surface mountable
- Low forward voltage drop
- High frequency operation
- Guard ring for enhanced ruggedness and long term reliability

#### Case Styles

10MQ100N



SMA

Cathode  Anode

**勝特力材料 886-3-5753170**  
**勝特力电子(上海) 86-21-54151736**  
**勝特力电子(深圳) 86-755-83298787**  
[Http://www.100y.com.tw](http://www.100y.com.tw)

## 10MQ100N

Bulletin PD-20520 rev. M 07/04

International  
**IR** Rectifier

### Voltage Ratings

Part number	10MQ100N
$V_R$ Max. DC Reverse Voltage (V)	100
$V_{RWM}$ Max. Working Peak Reverse Voltage (V)	

### Absolute Maximum Ratings

Parameters	10MQ	Units	Conditions
$I_{F(AV)}$ Max. Average Forward Current * See Fig. 4	1.5	A	50% duty cycle @ $T_L = 126^\circ\text{C}$ , rectangular wave form. On PC board 9mm <sup>2</sup> island (.013mm thick copper pad area)
$I_{FSM}$ Max. Peak One Cycle Non-Repetitive Surge Current * See Fig. 6, $T_J = 25^\circ\text{C}$	120	A	5 $\mu\text{s}$ Sine or 3 $\mu\text{s}$ Rect. pulse
	30		10ms Sine or 6ms Rect. pulse
$E_{AS}$ Non-Repetitive Avalanche Energy	1.0	mJ	$T_J = 25^\circ\text{C}$ , $I_{AS} = 0.5\text{A}$ , $L = 8\text{mH}$
$I_{AR}$ Repetitive Avalanche Current	0.5	A	

### Electrical Specifications

Parameters	10MQ	Units	Conditions
$V_{FM}$ Max. Forward Voltage Drop (1) * See Fig. 1	0.78	V	@ 1A
	0.85	V	@ 1.5A
	0.63	V	@ 1A
	0.68	V	@ 1.5A
$I_{RM}$ Max. Reverse Leakage Current (1) * See Fig. 2	0.1	mA	$T_J = 25^\circ\text{C}$
	1	mA	$T_J = 125^\circ\text{C}$
$V_{F(TO)}$ Threshold Voltage	0.52	V	$T_J = T_J \text{ max.}$
$r_t$ Forward Slope Resistance	78.4	m $\Omega$	
$C_T$ Typical Junction Capacitance	38	pF	$V_R = 10V_{DC}$ , $T_J = 25^\circ\text{C}$ , test signal = 1Mhz
$L_S$ Typical Series Inductance	2.0	nH	Measured lead to lead 5mm from package body
$dv/dt$ Max. Voltage Rate of Change (Rated $V_R$ )	10000	V/ $\mu\text{s}$	

(1) Pulse Width < 300 $\mu\text{s}$ , Duty Cycle < 2%

### Thermal-Mechanical Specifications

Parameters	10MQ	Units	Conditions
$T_J$ Max. Junction Temperature Range (*)	-55 to 150	$^\circ\text{C}$	
$T_{stg}$ Max. Storage Temperature Range	-55 to 150	$^\circ\text{C}$	
$R_{thJA}$ Max. Thermal Resistance Junction to Ambient	80	$^\circ\text{C}/\text{W}$	DC operation
wt Approximate Weight	0.07(0.002)	g(oz.)	
Case Style	SMA		Similar D-64
Device Marking	IR1J		

(\*)  $\frac{dP_{tot}}{dT_J} < \frac{1}{R_{th(j-a)}}$  thermal runaway condition for a diode on its own heatsink

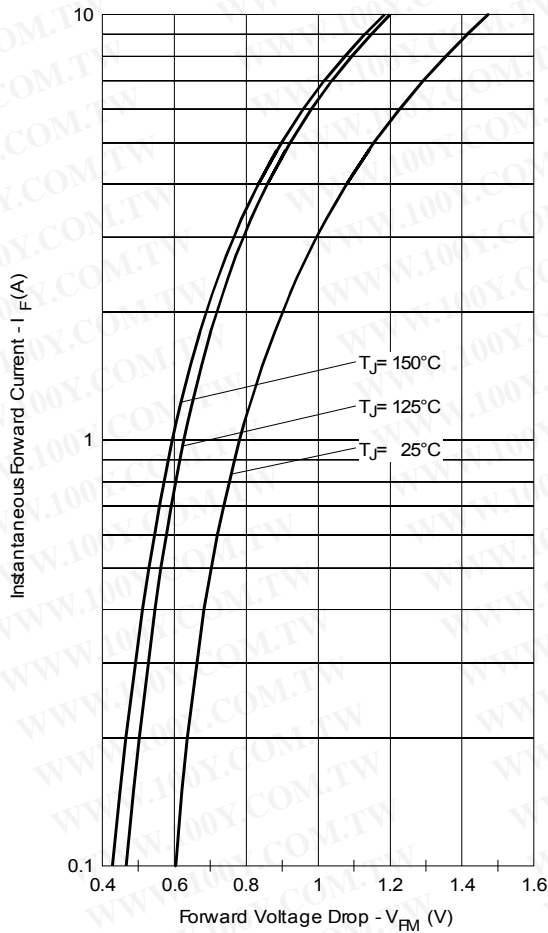

Fig. 1 - Maximum Forward Voltage Drop Characteristics

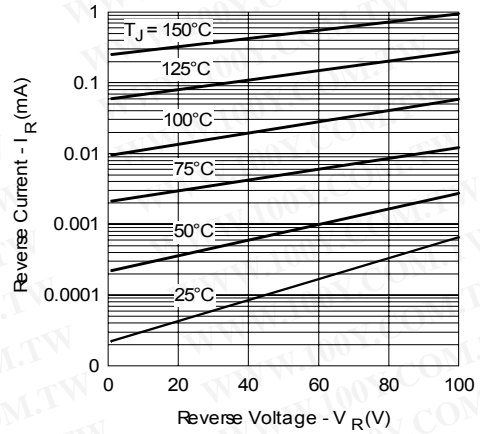

Fig. 2 - Typical Peak Reverse Current Vs. Reverse Voltage

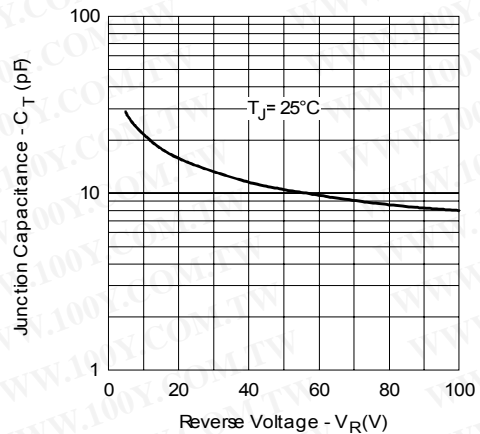

Fig. 3 - Typical Junction Capacitance Vs. Reverse Voltage

**10MQ100N**

Bulletin PD-20520 rev. M 07/04

International  
**IR** Rectifier

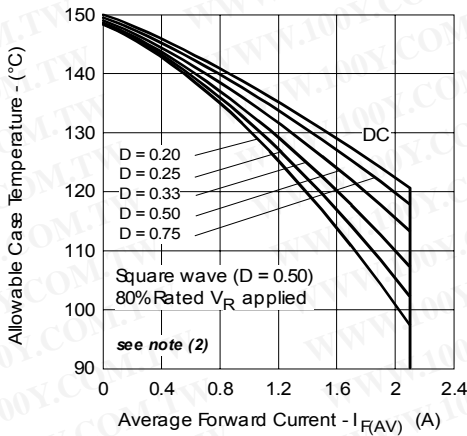

Fig. 4 - Maximum Average Forward Current Vs. Allowable Lead Temperature

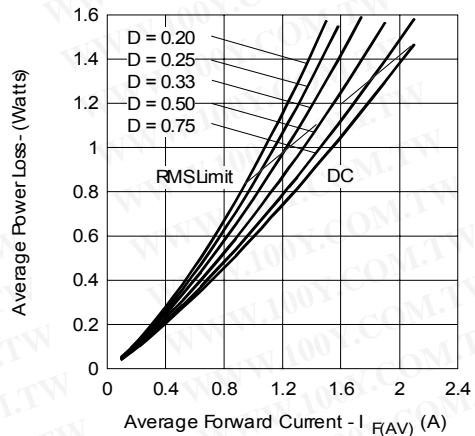

Fig. 5 - Maximum Average Forward Dissipation Vs. Average Forward Current

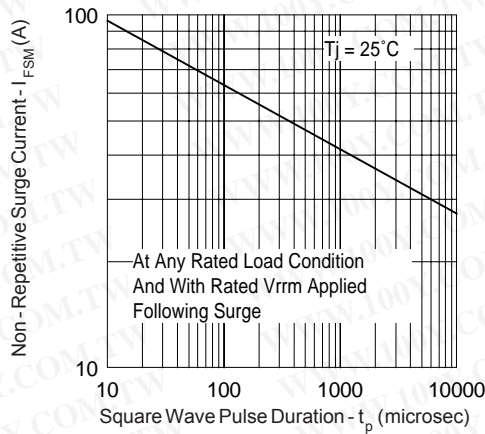
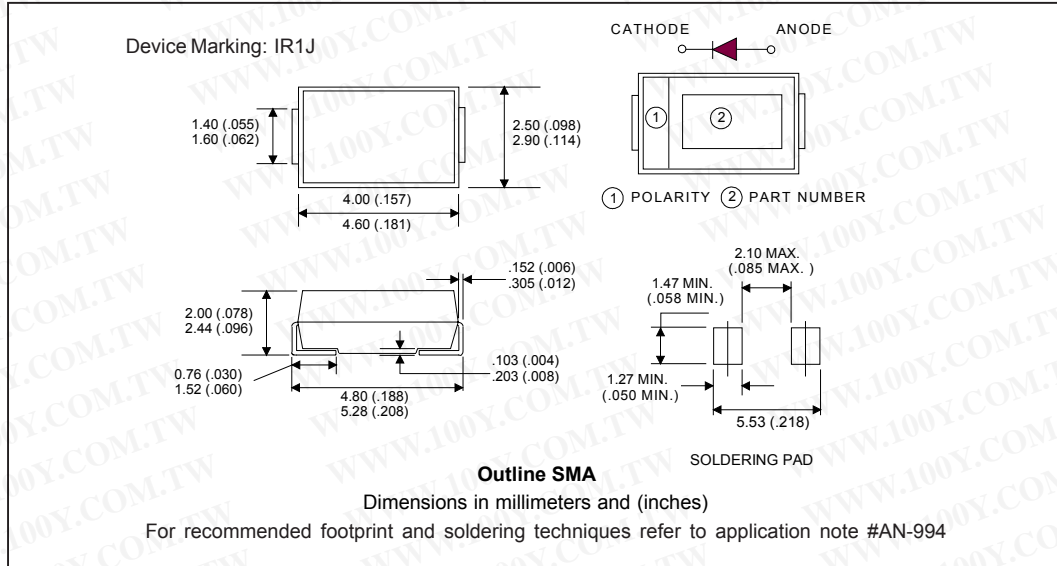

Fig. 6 - Maximum Peak Surge Forward Current Vs. Pulse Duration

(2) Formula used:  $T_c = T_j - (P_d + P_{d_{REV}}) \times R_{thJC}$ ;  
 $P_d = \text{Forward Power Loss} = I_{F(AV)} \times V_{FM} @ (I_{F(AV)} / D)$  (see Fig. 6);  
 $P_{d_{REV}} = \text{Inverse Power Loss} = V_{R1} \times I_R (1 - D)$ ;  $I_R @ V_{R1} = 80\% \text{ rated } V_R$

勝特力材料 886-3-5753170  
 勝特力电子(上海) 86-21-54151736  
 勝特力电子(深圳) 86-755-83298787  
[Http://www.100y.com.tw](http://www.100y.com.tw)

Outline Table



Marking & Identification

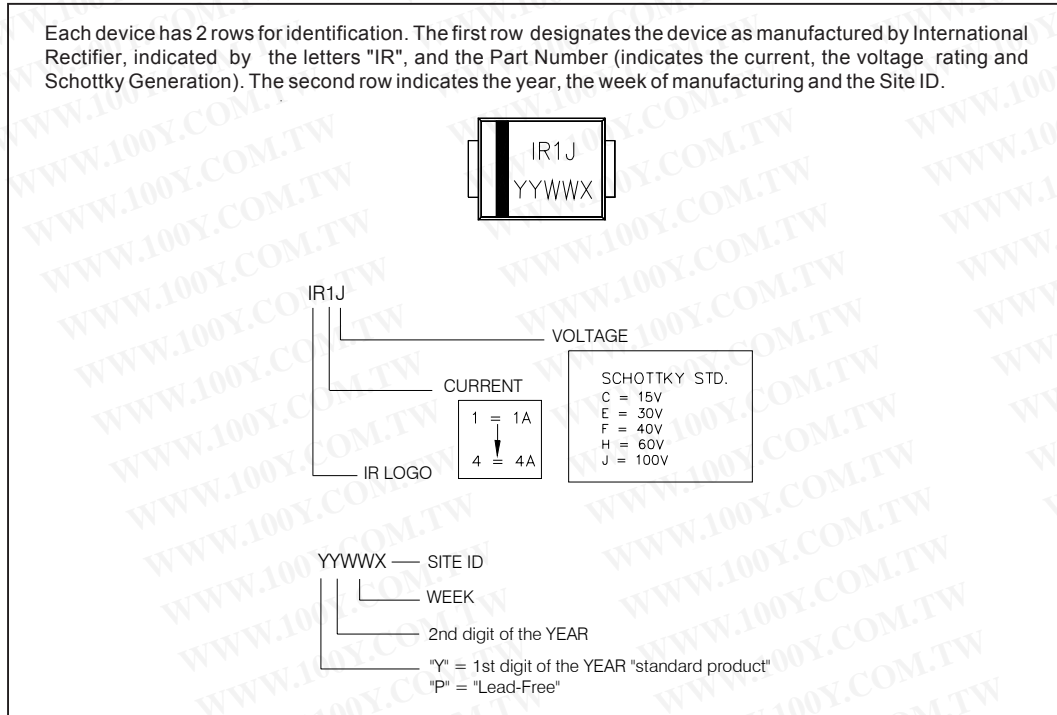

勝特力材料 886-3-5753170  
 勝特力电子(上海) 86-21-54151736  
 勝特力电子(深圳) 86-755-83298787  
[Http://www.100y.com.tw](http://www.100y.com.tw)

10MQ100N

Bulletin PD-20520 rev. M 07/04

International  
**IR** Rectifier

Tape & Reel Information

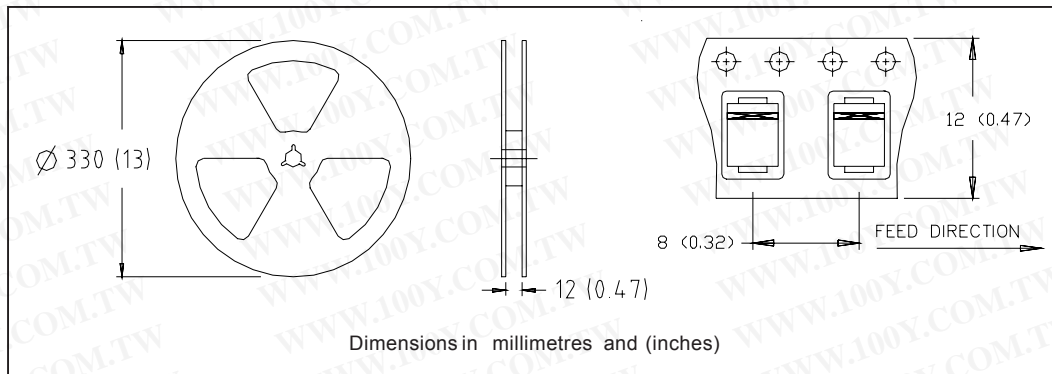

Ordering Information Table

Device Code						
10	M	Q	100	N	TR	-
①	②	③	④	⑤	⑥	⑦
<b>1</b>	-	Current Rating				
<b>2</b>	-	M = SMA				
<b>3</b>	-	Q = Schottky Q Series				
<b>4</b>	-	Voltage Rating (100 = 100V)				
<b>5</b>	-	N = New SMA				
<b>6</b>	-	• none = Box (1000 pieces)				
		• TR = Tape & Reel (7500 pieces)				
<b>7</b>	-	• none = Standard Production				
		• PbF = Lead-Free				

Data and specifications subject to change without notice.  
 This product has been designed and qualified for Industrial Level.  
 Qualification Standards can be found on IR's Web site.

International  
**IR** Rectifier

**IR WORLD HEADQUARTERS:** 233 Kansas St., El Segundo, California 90245, USA Tel: (310) 252-7105  
 TAC Fax: (310) 252-7309  
 Visit us at [www.irf.com](http://www.irf.com) for sales contact information. 07/04