

勝特力材料 886-3-5753170
勝特力电子(上海) 86-21-34970699
勝特力电子(深圳) 86-755-83298787
[Http://www.100y.com.tw](http://www.100y.com.tw)



Extract from the online
catalog

MC 1,5/14-G-3,81

Order No.: 1803390

The figure shows a 10-position version of the product

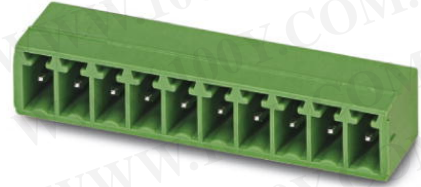

<http://eshop.phoenixcontact.de/phoenix/treeViewClick.do?UID=1803390>

Header, Nominal current: 8 A, Nom. voltage: 160 V, Pitch: 3.81 mm,
Number of positions: 14, Color: green, Assembly: Soldering

Commercial data

EAN	4017918045708
Pack	50 pcs.
Customs tariff	85366990
Weight/Piece	0.00383 KG
Catalog page information	Page 174 (CC-2009)

Product notes

WEEE/RoHS-compliant since:
01/01/2003



<http://www.download.phoenixcontact.com>
Please note that the data given here has been taken from the online catalog. For comprehensive information and data, please refer to the user documentation. The General Terms and Conditions of Use apply to Internet downloads.

Technical data

Dimensions / positions

Length	9.2 mm
Pitch	3.81 mm
Dimension a	49.53 mm
Number of positions	14
Pin dimensions	0,8 x 0,8 mm

Hole diameter	1.2 mm
Technical data	
Insulating material group	IIIa
Rated surge voltage (III/3)	2.5 kV
Rated surge voltage (III/2)	2.5 kV
Rated surge voltage (II/2)	2.5 kV
Rated voltage (III/2)	160 V
Rated voltage (II/2)	250 V
Connection in acc. with standard	EN-VDE
Nominal current I_N	8 A
Nominal voltage U_N	160 V
Maximum load current	8 A
Insulating material	PBT
Inflammability class acc. to UL 94	V0

Certificates / Approvals



Certification

CB, CSA, CUL, GOST, UL, VDE-PZI

CSA

Nominal voltage U_N	300 V
Nominal current I_N	8 A

CUL

Nominal voltage U_N	300 V
Nominal current I_N	8 A

UL

Nominal voltage U_N	300 V
Nominal current I_N	8 A

勝特力材料 886-3-5753170
 勝特力电子(上海) 86-21-34970699
 勝特力电子(深圳) 86-755-83298787
[Http://www.100y.com.tw](http://www.100y.com.tw)

Accessories

Item	Designation	Description
General		
1841174	MC 1,5/10-LWL 1,5-3,81	Fiber optics, Pitch: 3.81 mm, Number of positions: 10, Dimension a: 1.5 mm, Color: transparent
1841190	MC 1,5/10-LWL 2,3-3,81	Fiber optics, Pitch: 3.81 mm, Number of positions: 10, Dimension a: 2.3 mm, Color: transparent
1841213	MC 1,5/10-LWL 4-3,81	Fiber optics, Pitch: 3.81 mm, Number of positions: 10, Dimension a: 4 mm, Color: transparent
Marking		
1051993	B-STIFT	Marker pen, for manual labeling of unprinted Zack strips, smear-proof and waterproof, line thickness 0.5 mm
0804109	SK 3,81/2,8:FORTL.ZAHLEN	Marker card, printed horizontally, self-adhesive, 10-section marker strip, 14 identical decades marked 1-10, 11-20 etc. up to 91-(99)100, sufficient for 140 terminal blocks
0805056	SK 3,81/2,8:SO	Marker card, special printing, self-adhesive, labeled acc. to customer requirements, 14 identical marker strips per card, max. 25-position labeling per strip, color: White
Plug/Adapter		
1734634	CP-MSTB	Keying profile, is inserted into the slot on the plug or inverted header, red insulating material

Additional products

Item	Designation	Description
General		
1851164	FK-MCP 1,5/14-ST-3,81	Plug component, Nominal current: 8 A, Nom. voltage: 160 V, Pitch: 3.81 mm, Number of positions: 14, Connection type: Spring-cage conn., Color: green
1850783	FRONT-MC 1,5/14-ST-3,81	Plug component, Nominal current: 8 A, Nom. voltage: 160 V, Pitch: 3.81 mm, Number of positions: 14, Connection type: Screw connection, Color: green
1862690	IMC 1,5/14-G-3,81	Header, Nominal current: 8 A, Nom. voltage: 160 V, Pitch: 3.81 mm, Number of positions: 14, Color: green, Assembly: Soldering
1875548	IMCV 1,5/14-G-3,81	Header, Nominal current: 8 A, Nom. voltage: 160 V, Pitch: 3.81 mm, Number of positions: 14, Color: green, Assembly: Soldering
1803691	MC 1,5/14-ST-3,81	Plug component, Nominal current: 8 A, Nom. voltage: 160 V, Pitch: 3.81 mm, Number of positions: 14, Connection type: Screw connection, Color: green

1852299	MCC 1/14-STZ-3,81	Plug component, Nominal current: 8 A, Nom. voltage: 160 V, Pitch: 3.81 mm, Number of positions: 14, Connection type: Crimp connection, Color: green
1827240	MCVR 1,5/14-ST-3,81	Plug component, Nominal current: 8 A, Nom. voltage: 160 V, Pitch: 3.81 mm, Number of positions: 14, Connection type: Screw connection, Color: green
1827091	MCVW 1,5/14-ST-3,81	Plug component, Nominal current: 8 A, Nom. voltage: 160 V, Pitch: 3.81 mm, Number of positions: 14, Connection type: Screw connection, Color: green
1897513	QC 0,5/14-ST-3,81	Plug component, Nominal current: 6 A, Nom. voltage: 320 V, Pitch: 3.81 mm, Number of positions: 14, Connection type: Insulation displacement connection QUICKON, Color: green

Diagrams/Drawings

Drilling plan/solder pad geometry

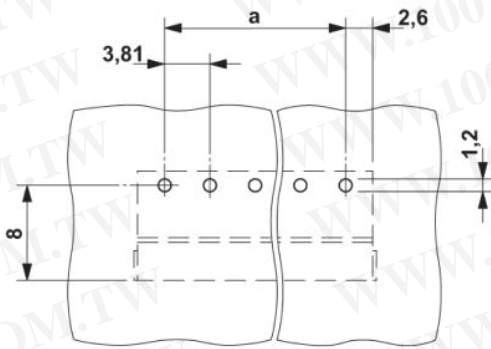

勝特力材料 886-3-5753170
 勝特力电子(上海) 86-21-34970699
 勝特力电子(深圳) 86-755-83298787
[Http://www.100y.com.tw](http://www.100y.com.tw)

Dimensioned drawing

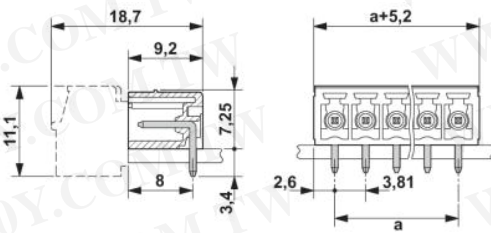

Address

PHOENIX CONTACT Inc., USA
586 Fulling Mill Road
Middletown, PA 17057, USA
Phone (800) 888-7388
Fax (717) 944-1625
<http://www.phoenixcon.com>



勝特力材料 886-3-5753170
勝特力电子(上海) 86-21-34970699
勝特力电子(深圳) 86-755-83298787
[Http://www.100y.com.tw](http://www.100y.com.tw)

© 2010 Phoenix Contact
Technical modifications reserved;