

HX25004-25005(EH)条形连接器

销售咨询

技术咨询

品质咨询

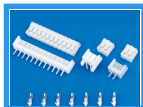
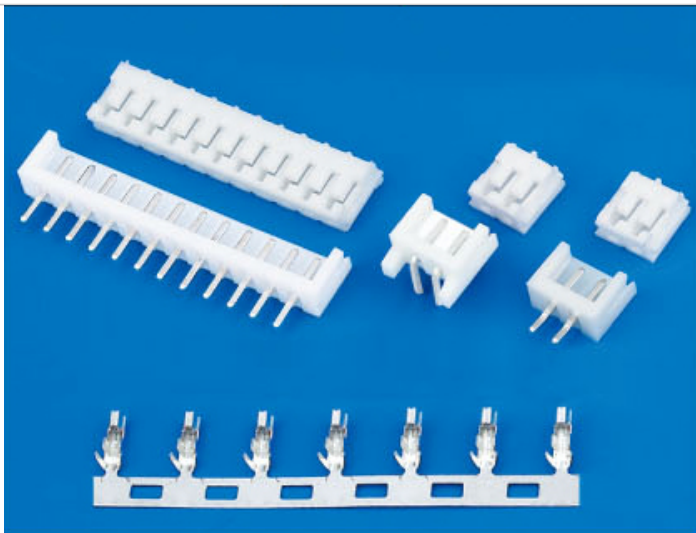

勝特力材料 886-3-5773766
勝特力电子(上海) 86-21-34970699
勝特力电子(深圳) 86-755-83298787
[Http://www.100y.com.tw](http://www.100y.com.tw)

详情

文件下载

安装

HXH[®]

(EH)型条形连接器

(EH) Pressure Welding Bar Connector

间距 (Pitch) : 2.5mm (.098")

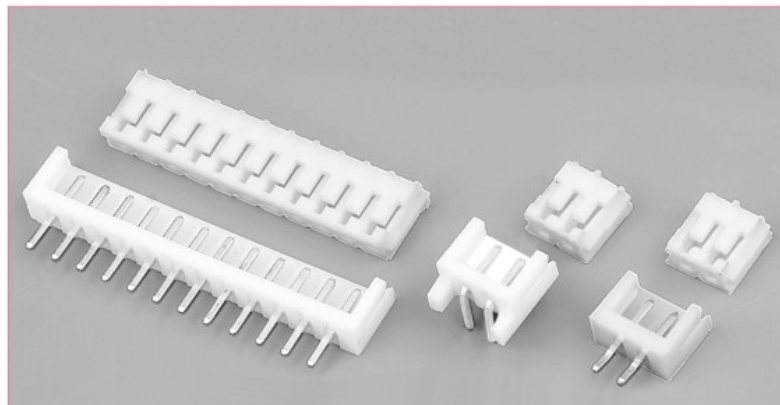

■ 技术参数 SPECIFICATIONS

- 线数 (Poles) : 2~13(30)
- 适用线规 (Applicable wires) : AWG28#~22#
- 适应基板厚度 (Applicable PC board thickness) : 1.6mm
- 温度范围 (Temperature range) : -25°C~85°C
- 额定电压 (Voltage rating) : 250V.Ac/Dc
- 额定电流 (Current rating) : 3A
- 接触电阻 (Contact resistance) : $\leq 0.02\Omega$
- 绝缘电阻 (Insulation resistance) : $\geq 1000M\Omega$
- 耐压 (Withstand voltage) : 1000V.Ac/1min

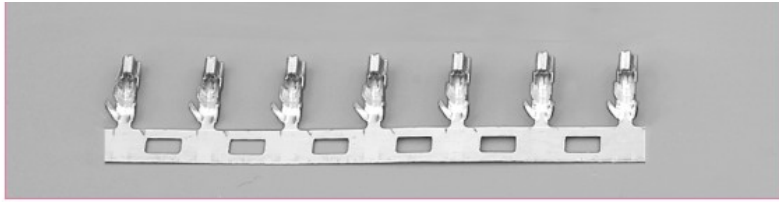

■ 材料 (Material) :

孔座 (Housing) : 尼龙 (PA66) UL94V-2(0)

针座 (Wafer) : 尼龙 (PA66) UL94V-2(0)

端子 (Terminal) : 磷青铜 (Phos.bronze Tin/plated)

端子 TERMINAL(EH)

型号 Type	适用线规 Applicable wires		电线外径 O.D of wire ins mm	数量 Quantity
	mm ²	AWG#		
HX25004-PT	0.08-0.3	28-22	1.0-1.8	8000PCS/盘

HX25004-PT (EH)

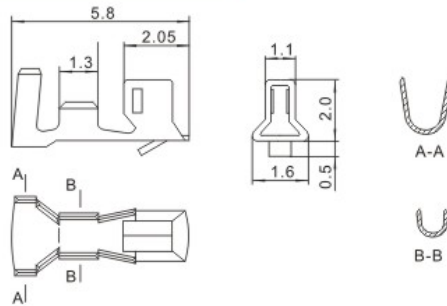

HX25004-Y (EH)

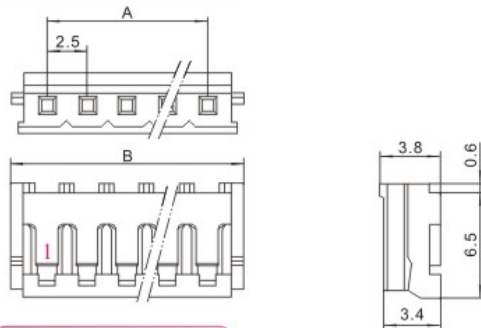

HX25005-A (EH)

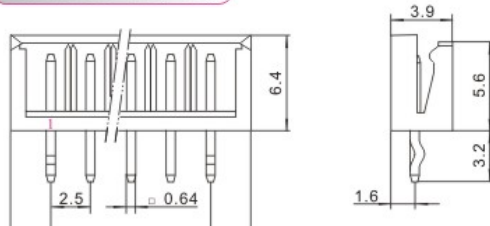

HX25005-WAP (EH)

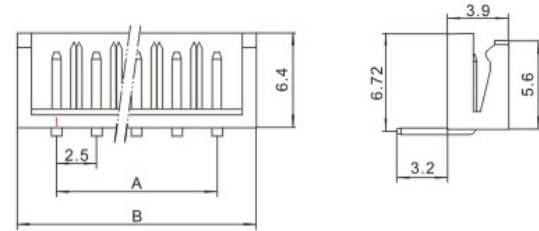

HX25005-WAD (EH)

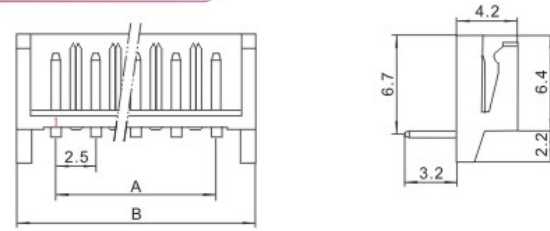

■ 安装尺寸 MOUNTING MEASUREMENT

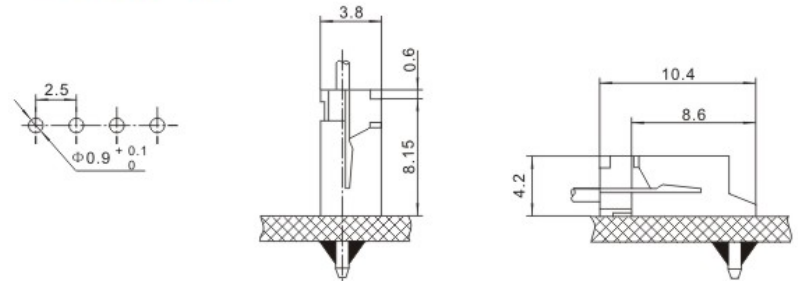

孔座 HOUSING (EH)

线数 Poles	型号 Type	尺寸Dimensions(mm)	
		A	B
2	HX25004-2Y	2.5	7.0
3	HX25004-3Y	5.0	9.5
4	HX25004-4Y	7.5	12.0

针座 WAFER (EH)

线数 Poles	型号 Type		尺寸Dimensions(mm)	
	直式(180°)	弯式(90°)	A	B
2	HX25005-2A	HX25005-2WA	2.5	7.5
3	HX25005-3A	HX25005-3WA	5.0	10.0
4	HX25005-4A	HX25005-4WA	7.5	12.5

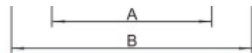

HX25005-AN (EH)

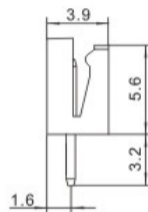
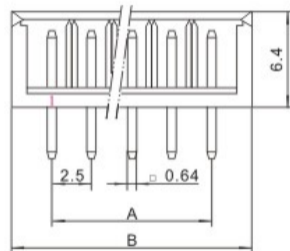

5	HX25004-5Y	10.0	14.5
6	HX25004-6Y	12.5	17.0
7	HX25004-7Y	15.0	19.5
8	HX25004-8Y	17.5	22.0
9	HX25004-9Y	20.0	24.5
10	HX25004-10Y	22.5	27.0
11	HX25004-11Y	25.0	29.5
12	HX25004-12Y	27.5	32.0
13	HX25004-13Y	30.0	34.5
...
30	HX25004-30Y	72.5	77.0

5	HX25005-5A	HX25005-5WA	10.0	15.0
6	HX25005-6A	HX25005-6WA	12.5	17.5
7	HX25005-7A	HX25005-7WA	15.0	20.0
8	HX25005-8A	HX25005-8WA	17.5	22.5
9	HX25005-9A	HX25005-9WA	20.0	25.0
10	HX25005-10A	HX25005-10WA	22.5	27.5
11	HX25005-11A	HX25005-11WA	25.0	30.0
12	HX25005-12A	HX25005-12WA	27.5	32.5
13	HX25005-13A	HX25005-13WA	30.0	35.0
...
30	HX25005-30A	HX25005-30WA	72.5	77.5