

4.2 mm PE Series Connector System

(Wire-to-Wire, Wire-to-Board and Wire-to-Panel)

Revised 06/04 1309245

DESCRIPTION

- Low cost, wire-to-wire, wire-to-board and wire-to-panel connectors with 4.2 mm centerline

APPLICATIONS

- Computer motherboards/power supplies
- Harness assemblies used in the Vending, Gaming and Appliance industries
- Car alarm systems
- Heating systems

KEY FEATURES

- Easy mate and unmate with positive latch design
- Single-row, 3-5 positions: receptacles, panel mount or free-hanging plugs
- Double-row, 2-24 positions (even only): receptacles, panel mount or free-hanging plugs, and vertical or right-angle pin headers
- Available in UL 94V-2 or UL 94V-0 flammability rated nylon
- Products are lead free to help promote a cleaner environment
- Intermateable and interchangeable with Molex Mini-Fit, Jr. and intermateable AMP-DUAC connectors

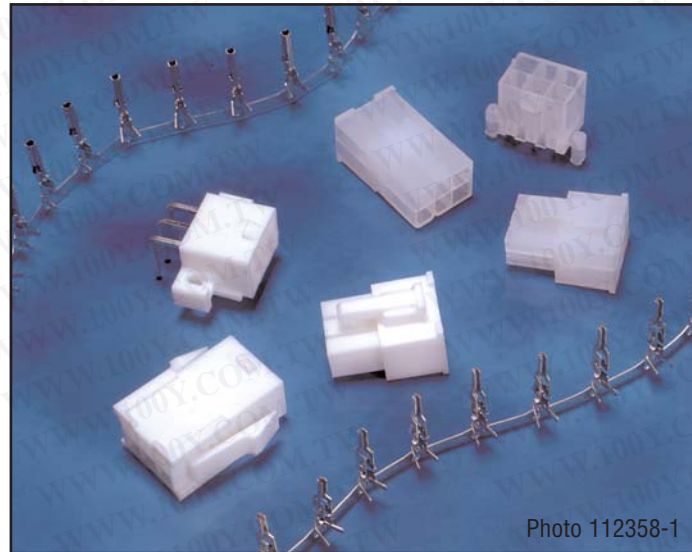

Photo 112358-1

ELECTRICAL

- Voltage: 600 VAC
- Current: 9 amps max. in 2-position applications
- Dielectric Withstanding Voltage: 1500 VAC min.
- Insulation Resistance: 1000 megohms min.

MECHANICAL

- Connector Mating: 1.55 lb. [6.90 N] max. per circuit
- Connector Unmating: .11 lb. [.49 N] min. per circuit
- Contact Retention: 4.88 lb. [21.71 N] min. per contact
- Durability: 50 cycles, mating and unmating

MATERIALS

- Housings: Nylon, UL 94V-2 and UL 94V-0
- Contacts: Brass or Phos. Bronze with tin plating (Lead-Free) or gold plating

STANDARDS & SPECS

- Component Recognized by UL and Certified by CSA
- UL File No. E28476 and CSA File No. 208567
- Tyco Electronics Design For Environment (DFE) Standard 230-5

new product

4.2 mm PE Series Connector System

(Wire-to-Wire, Wire-to-Board and Wire-to-Panel)

HOUSINGS □ PRODUCT OFFERING & DIMENSIONS

SINGLE ROW

No. of Positions	UL 94V-2 Housings			UL 94V-0 Housings		
	Panel Mount Plug	Free-Hanging Plug	Receptacle Housing	Panel Mount Plug	Free-Hanging Plug	Receptacle Housing
3*	1586101-3	1586103-3	1586105-3	1586102-3	1586104-3	1586106-3
4	1586022-4	1586024-4	1586026-4	1586023-4	1586025-4	1586027-4
5	1586022-5	1586024-5	1586026-5	1586023-5	1586025-5	1586027-5

*Note: 3 position housings are First Mate/Last Break.

Panel Mount Plug Housing

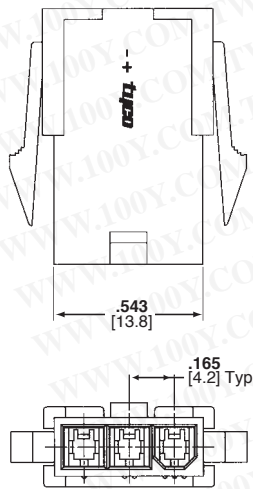

Receptacle Housing

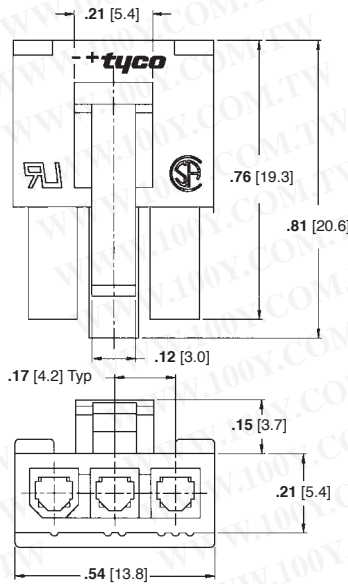

Free-Hanging Plug Housing

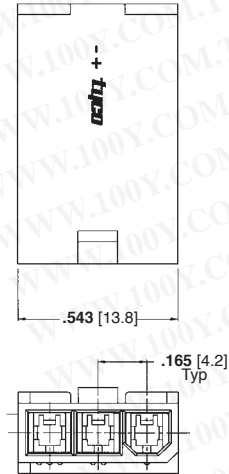

DOUBLE ROW

No. of Positions	UL 94V-2 Housings			UL 94V-0 Housings		
	Panel Mount Plug	Free-Hanging Plug	Receptacle Housing	Panel Mount Plug	Free-Hanging Plug	Receptacle Housing
2	794953-2	1586000-2	794954-2	1586018-2	1586017-2	1586019-2
4	794953-4	1586000-4	794954-4	1586018-4	1586017-4	1586019-4
6	794953-6	1586000-6	794954-6	1586018-6	1586017-6	1586019-6
8	794953-8	1586000-8	794954-8	1586018-8	1586017-8	1586019-8
10	1-794953-0	1-1586000-0	1-794954-0	1-1586018-0	1-1586017-0	1-1586019-0
12	1-794953-2	1-1586000-2	1-794954-2	1-1586018-2	1-1586017-2	1-1586019-2
14	1-794953-4	1-1586000-4	1-794954-4	1-1586018-4	1-1586017-4	1-1586019-4
16	1-794953-6	1-1586000-6	1-794954-6	1-1586018-6	1-1586017-6	1-1586019-6
18	1-794953-8	1-1586000-8	1-794954-8	1-1586018-8	1-1586017-8	1-1586019-8
20	2-794953-0	2-1586000-0	2-794954-0	2-1586018-0	2-1586017-0	2-1586019-0
22	2-794953-2	2-1586000-2	2-794954-2	2-1586018-2	2-1586017-2	2-1586019-2
24	2-794953-4	2-1586000-4	2-794954-4	2-1586018-4	2-1586017-4	2-1586019-4

Note: Plug housings accept pin contacts and receptacle housings accept socket contacts on page 4.

Panel Mount Plug Housing

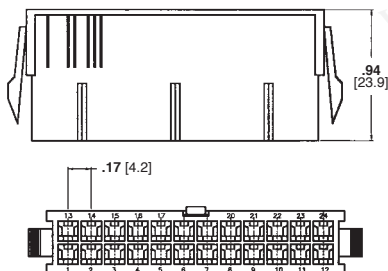

Receptacle Housing

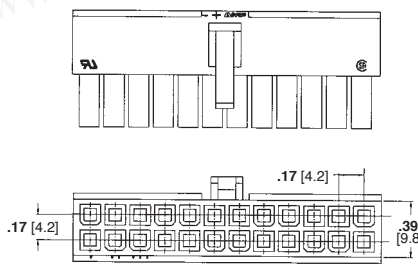

Free-Hanging Plug Housing

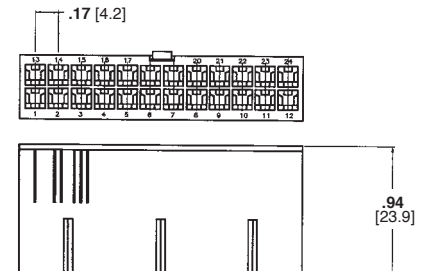

4.2 mm PE Series Connector System

(Wire-to-Wire, Wire-to-Board and Wire-to-Panel)

PIN HEADERS □ PRODUCT OFFERING

No. of Positions	UL 94V-2 Pin Headers				UL 94V-0 Pin Headers			
	Vertical		Right-Angle		Vertical		Right-Angle	
	w/o Pegs	w/Pegs	w/o Pegs	Screw Mount	w/o Pegs	w/Pegs	w/o Pegs	Screw Mount
2	1586037-2	1586039-2	1586041-2	1586043-2	1586038-2	1586040-2	1586042-2	1586044-2
4	1586037-4	1586039-4	1586041-4	1586043-4	1586038-4	1586040-4	1586042-4	1586044-4
6	1586037-6	1586039-6	1586041-6	1586043-6	1586038-6	1586040-6	1586042-6	1586044-6
8	1586037-8	1586039-8	1586041-8	1586043-8	1586038-8	1586040-8	1586042-8	1586044-8
10	1-1586037-0	1-1586039-0	1-1586041-0	1-1586043-0	1-1586038-0	1-1586040-0	1-1586042-0	1-1586044-0
12	1-1586037-2	1-1586039-2	1-1586041-2	1-1586043-2	1-1586038-2	1-1586040-2	1-1586042-2	1-1586044-2
14	1-1586037-4	1-1586039-4	1-1586041-4	1-1586043-4	1-1586038-4	1-1586040-4	1-1586042-4	1-1586044-4
16	1-1586037-6	1-1586039-6	1-1586041-6	1-1586043-6	1-1586038-6	1-1586040-6	1-1586042-6	1-1586044-6
18	1-1586037-8	1-1586039-8	1-1586041-8	1-1586043-8	1-1586038-8	1-1586040-8	1-1586042-8	1-1586044-8
20	2-1586037-0	2-1586039-0	2-1586041-0	2-1586043-0	2-1586038-0	2-1586040-0	2-1586042-0	2-1586044-0
22	2-1586037-2	2-1586039-2	2-1586041-2	2-1586043-2	2-1586038-2	2-1586040-2	2-1586042-2	2-1586044-2
24	2-1586037-4	2-1586039-4	2-1586041-4	2-1586043-4	2-1586038-4	2-1586040-4	2-1586042-4	2-1586044-4

Note: All Headers have Brass, Tin-Plated contacts.

PRODUCT DIMENSIONS

Vertical Pin Headers (Part No. 1586037 shown w/o pegs)

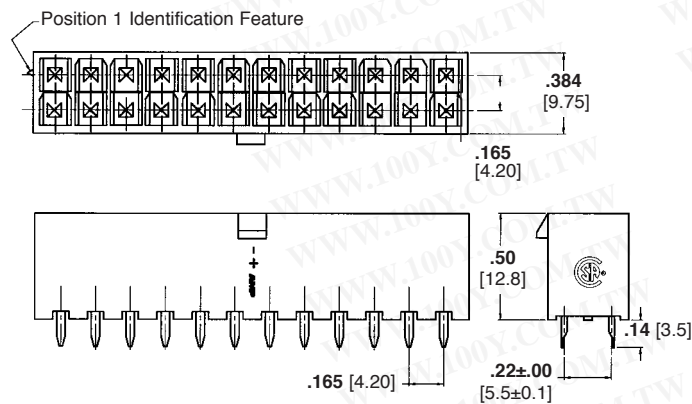

Right-Angle Pin Headers (Part No. 1586043 Screw Mount)

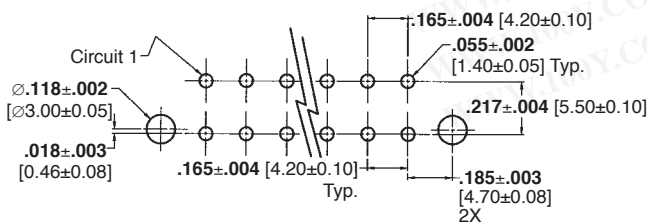
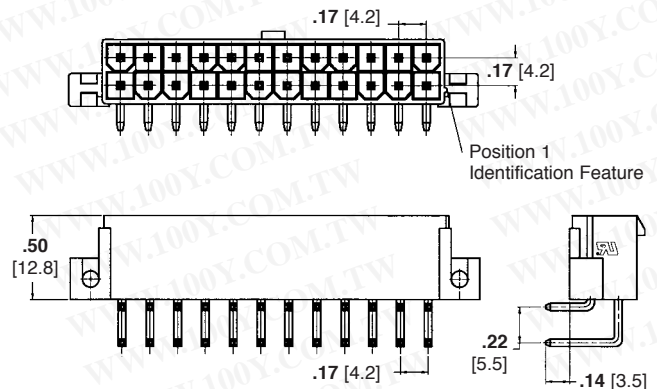

PCB Layout: Component Side (shown with pegs)
Recommended Board Thickness .070 [1.78]

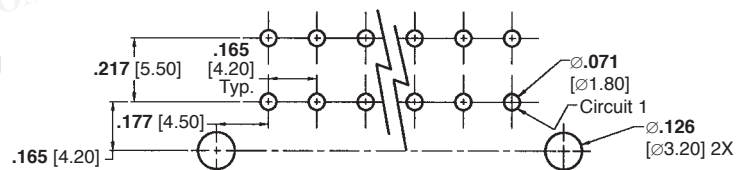

PCB Layout: Component Side (screw mount shown)
Recommended Board Thickness .063 [1.60]

4.2 mm PE Series Connector System

(Wire-to-Wire, Wire-to-Board and Wire-to-Panel)

CONTACTS □ PRODUCT OFFERING

Wire Range (AWG)	Material & Finish	Pin		Socket		Applicator Part Number ¹	Hand Tool Part Number
		Strip Form	Loose Form	Strip Form	Loose Form		
26-22	Brass, Pre-Tin	794957-1	1586316-1	794958-1	1586317-1	1385448-X	91387-1
	Phos. Brz., Pre-Tin	794957-3	1586316-3	794958-3	1586317-3		
	Brass, Gold	794957-2	1586316-2	794958-2	1586317-2		
	Phos. Brz., Gold	794957-4	1586316-4	794958-4	1586317-4		
22-18	Brass, Pre-Tin	794955-1	1586314-1	794956-1	1586315-1	680557-X	91388-1
	Phos. Brz., Pre-Tin	794955-3	1586314-3	794956-3	1586315-3		
	Brass, Gold	794955-2	1586314-2	794956-2	1586315-2		
	Phos. Brz., Gold	794955-4	1586314-4	794956-4	1586315-4		

Extraction Tool Part Number 1586343-1

¹ For applicator and machine part numbers, contact Technical Support.

SOCKET

(used in Receptacle Housing)

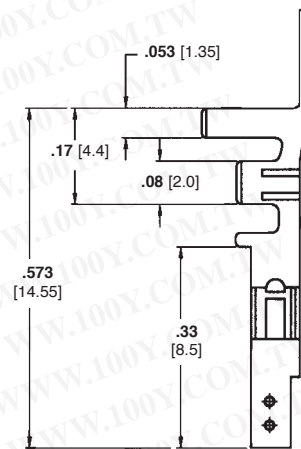

PIN

(used in Plug Housing)

