

Aluminum Capacitors Radial Miniature Long Life

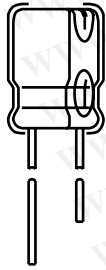
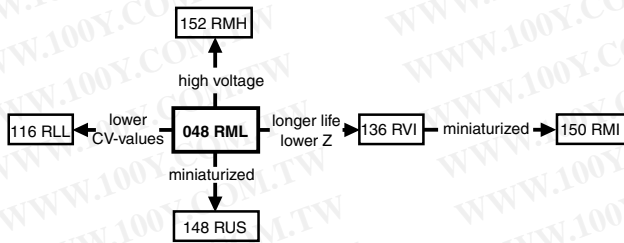


Fig.1 Component outline



FEATURES

- Polarized aluminum electrolytic capacitors, non-solid electrolyte
- Radial leads, cylindrical aluminum case with pressure relief, insulated with a blue vinyl sleeve
- Charge and discharge proof
- Miniaturized, high CV-product per unit volume
- Very long useful life: 3000 hours to 4000 hours at 105 °C, high reliability
- Compliant to RoHS directive 2002/95/EC



RoHS
 COMPLIANT

APPLICATIONS

- EDP, telecommunication, industrial, automotive and audio-video
- Smoothing, filtering, buffering in SMPS, timing
- Portable and mobile equipment (small size, low mass)

MARKING

The capacitors are marked (where possible) with the following information:

- Rated capacitance (in μF)
- Tolerance on rated capacitance, code letter in accordance with IEC 60062 (M for $\pm 20\%$)
- Rated voltage (in V)
- Date code, in accordance with IEC 60062
- Code indicating factory of origin
- Name of manufacturer
- Upper category temperature (105 °C)
- Negative terminal identification
- Series number (048)

QUICK REFERENCE DATA	
DESCRIPTION	VALUE
Nominal case sizes ($\varnothing D \times L$ in mm)	10 x 12 to 18 x 35
Rated capacitance range, C_R	100 μF to 10 000 μF
Tolerance on C_R	$\pm 20\%$
Rated voltage range, U_R	6.3 to 63 V
Category temperature range	- 40 °C to + 105 °C
Endurance test at 105 °C	2000 hours
Useful life at 105 °C	
case $\varnothing D = 10$ mm and 12.5 mm	3000 hours
case $\varnothing D = 16$ mm and 18 mm	4000 hours
Useful life at 40 °C, 1.6 x I_R applied	
case $\varnothing D = 10$ mm and 12.5 mm	200 000 hours
case $\varnothing D = 16$ mm and 18 mm	260 000 hours
Shelf life at 0 V, 105 °C	1000 hours
Based on sectional specification	IEC 60384-4/EN130300
Climatic category IEC 60068	40/105/56

SELECTION CHART FOR C_R , U_R AND RELEVANT NOMINAL CASE SIZES ($\varnothing D \times L$ in mm)								
C_R (μF)	U_R (V)							
	6.3	10	16	25	35	40	50	63
100	-	-	-	-	-	-	-	10 x 12
220	-	-	-	-	10 x 12	-	10 x 16	10 x 20
330	-	-	-	-	-	-	-	12.5 x 20
470	-	-	10 x 12	10 x 16	10 x 20	-	12.5 x 20	12.5 x 25
1000	-	10 x 16	10 x 20	12.5 x 20	12.5 x 25	-	16 x 25	16 x 31
2200	-	12.5 x 20	12.5 x 25	16 x 25	16 x 31	16 x 35	18 x 35	18 x 35
3300	-	12.5 x 25	16 x 25	16 x 31	18 x 35	18 x 35	18 x 35	-
4700	-	16 x 25	16 x 31	18 x 35	18 x 35	-	-	-
6800	16 x 25	16 x 31	16 x 35	-	-	-	-	-
10 000	16 x 35	18 x 35	18 x 35	-	-	-	-	-

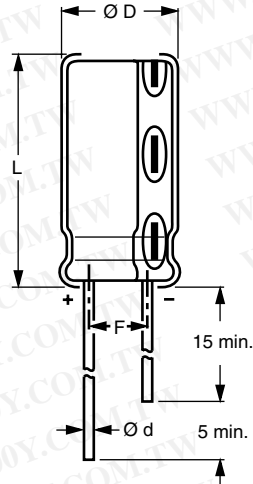
DIMENSIONS in millimeters, **AND AVAILABLE FORMS**


Fig.2 Form CA: Long leads

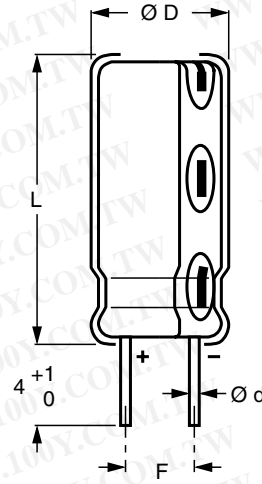


Fig.3 Form CB: Cut leads

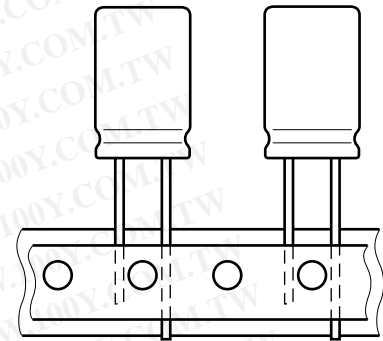

 Fig.4 Form TFA: Taped in box
 (ammopack)

Table 1

DIMENSIONS in millimeters, MASS AND PACKAGING QUANTITIES									
NOMINAL CASE SIZE Ø D x L	CASE CODE	Ø d	Ø D _{max.}	L _{max.}	F	MASS (g)	PACKAGING QUANTITIES		
							Form CA	Form CB	Form TFA
10 x 12	14	0.6	10.5	13.5	5.0 ± 0.5	≈ 1.6	1000	500	800
10 x 16	15	0.6	10.5	17.5	5.0 ± 0.5	≈ 1.9	500	500	800
10 x 20	16	0.6	10.5	22.0	5.0 ± 0.5	≈ 2.2	500	500	800
12.5 x 20	17	0.6	13.0	22.0	5.0 ± 0.5	≈ 4.0	500	500	500
12.5 x 25	18	0.6	13.0	27.0	5.0 ± 0.5	≈ 5.0	250	250	500
16 x 25	19	0.8	16.5	27.0	7.5 ± 0.5	≈ 8.0	250	250	250
16 x 31	20	0.8	16.5	33.5	7.5 ± 0.5	≈ 9.0	100	100	250
16 x 35	21	0.8	16.5	37.5	7.5 ± 0.5	≈ 11.5	100	100	-
18 x 35	22	0.8	18.5	37.5	7.5 ± 0.5	≈ 14.5	100	100	-

Note

Detailed tape dimensions see section 'PACKAGING'.

ELECTRICAL DATA	
SYMBOL	DESCRIPTION
C_R	rated capacitance at 100 Hz, tolerance $\pm 20\%$
I_R	rated RMS ripple current at 100 Hz, 105 °C
I_{L1}	max. leakage current after 1 minute at U_R
$\tan \delta$	max. dissipation factor at 100 Hz
Z	max. impedance at 100 kHz

Note

Unless otherwise specified, all electrical values in Table 2 apply at $T_{amb} = 20\text{ °C}$, $P = 86\text{ kPa}$ to 106 kPa , $RH = 45\%$ to 75% .

Table 2

ELECTRICAL DATA AND ORDERING INFORMATION									
U_R (V)	C_R 100 Hz (μF)	DIMENSIONS $\varnothing D \times L$ (mm)	I_R 100 Hz 105 °C (mA)	I_{L1} 1 min (μA)	$\tan \delta$ 100 Hz	Z 100 kHz (m Ω)	ORDERING NUMBER MAL2048.....		
							BULK PACKAGING		TAPED
							Form CA	Form CB	Form TFA
6.3	6800	16 x 25	1350	430	0.32	56	53682E3	63682E3	33682E3
	10 000	16 x 35	1700	630	0.40	42	53103E3	63103E3	-
10	1000	10 x 16	470	100	0.19	180	54102E3	64102E3	34102E3
	2200	12.5 x 20	800	220	0.21	90	54222E3	64222E3	34222E3
	3300	12.5 x 25	1000	330	0.23	68	54332E3	64332E3	34332E3
	4700	16 x 25	1270	470	0.25	56	54472E3	64472E3	34472E3
	6800	16 x 31	1550	680	0.29	45	54682E3	64682E3	34682E3
	10 000	18 x 35	1870	1000	0.37	36	54103E3	64103E3	-
16	470	10 x 12	360	78	0.16	250	55471E3	65471E3	35471E3
	1000	10 x 20	600	160	0.16	140	55102E3	65102E3	35102E3
	2200	12.5 x 25	1000	360	0.18	70	55222E3	65222E3	35222E3
	3300	16 x 25	1220	530	0.20	56	55332E3	65332E3	35332E3
	4700	16 x 31	1500	760	0.22	45	55472E3	65472E3	35472E3
	6800	16 x 35	1690	1100	0.26	42	55682E3	65682E3	-
25	10 000	18 x 35	1980	1600	0.34	34	55103E3	65103E3	-
	470	10 x 16	440	120	0.14	180	56471E3	66471E3	36471E3
35	1000	12.5 x 20	720	250	0.14	100	56102E3	66102E3	36102E3
	2200	16 x 25	1120	550	0.16	56	56222E3	66222E3	36222E3
	3300	16 x 31	1450	830	0.18	45	56332E3	66332E3	36332E3
	4700	18 x 35	1720	1200	0.20	36	56472E3	66472E3	-
40	220	10 x 12	310	80	0.12	280	50221E3	60221E3	30221E3
	470	10 x 20	500	170	0.12	150	50471E3	60471E3	30471E3
	1000	12.5 x 25	900	350	0.12	75	50102E3	60102E3	30102E3
	2200	16 x 31	1340	770	0.14	45	50222E3	60222E3	30222E3
	3300	18 x 35	1600	1200	0.16	36	50332E3	60332E3	-
	4700	18 x 35	1950	1600	0.18	34	50472E3	60472E3	-
50	2200	16 x 35	1500	880	0.13	45	57222E3	67222E3	-
	3300	18 x 35	1600	1300	0.15	36	57332E3	67332E3	-
63	220	10 x 16	340	110	0.10	250	51221E3	61221E3	31221E3
	470	12.5 x 20	620	240	0.10	110	51471E3	61471E3	31471E3
	1000	16 x 25	1030	500	0.10	60	51102E3	61102E3	31102E3
	2200	18 x 35	1500	1100	0.12	50	51222E3	61222E3	-
	3300	18 x 35	1900	1700	0.14	40	51332E3	61332E3	-
63	100	10 x 12	240	66	0.09	310	58101E3	68101E3	38101E3
	220	10 x 20	400	140	0.09	200	58221E3	68221E3	38221E3
	330	12.5 x 20	550	210	0.09	120	58331E3	68331E3	38331E3
	470	12.5 x 25	700	300	0.09	80	58471E3	68471E3	38471E3
	1000	16 x 31	1150	630	0.09	49	58102E3	68102E3	38102E3
	2200	18 x 35	1600	1400	0.11	45	58222E3	68222E3	-

ORDERING EXAMPLE

Electrolytic capacitor 048 series

2200 $\mu\text{F}/16\text{ V}$; $\pm 20\%$

Nominal case size: $\varnothing 12.5\text{ mm} \times 25\text{ mm}$; Form TFA

Ordering code: MAL204835222E3

Former 12NC: 2222 048 35222



ADDITIONAL ELECTRICAL DATA		
PARAMETER	CONDITIONS	VALUE
Voltage		
Surge voltage		$U_s \leq 1.15 U_R$
Reverse voltage		$U_{rev} \leq 1 V$
Current		
Leakage current	After 1 minute at U_R	$I_{L1} \leq 0.01 C_R \times U_R + 3 \mu A$
	After 5 minutes at U_R	$I_{L5} \leq 0.002 C_R \times U_R + 3 \mu A$
Inductance		
Equivalent series inductance (ESL)	Case $\varnothing D = 10 \text{ mm}$	typ. 16 nH
	Case $\varnothing D \geq 12.5 \text{ mm}$	typ. 18 nH
Resistance		
Equivalent series resistance (ESR)	Calculated from $\tan \delta_{max}$ and C_R (see Table 2)	$ESR = \tan \delta / 2 \pi f C_R$

CAPACITANCE (C)

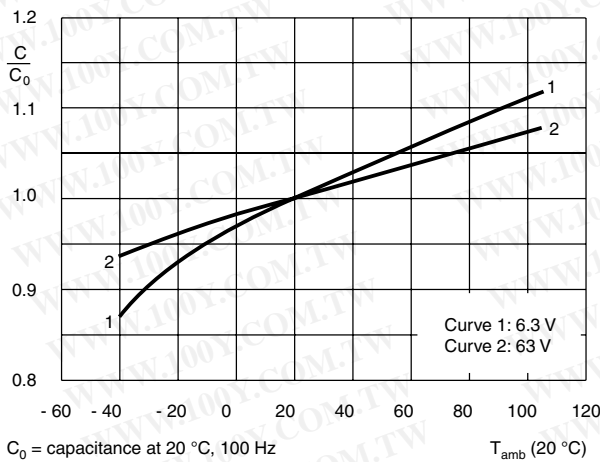


Fig.5 Typical multiplier of capacitance as a function of ambient temperature

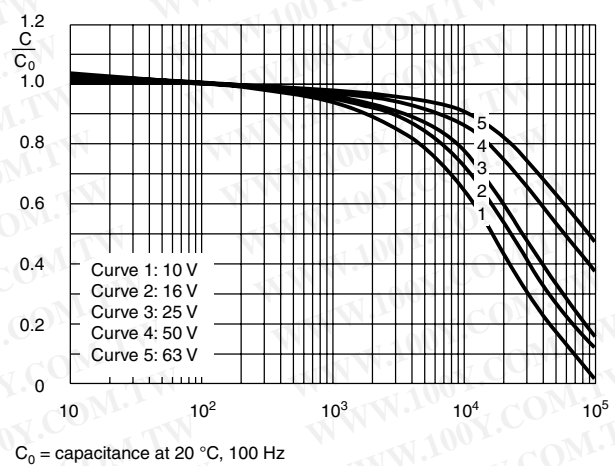


Fig.6 Typical multiplier of capacitance as a function of frequency

EQUIVALENT SERIES RESISTANCE (ESR)

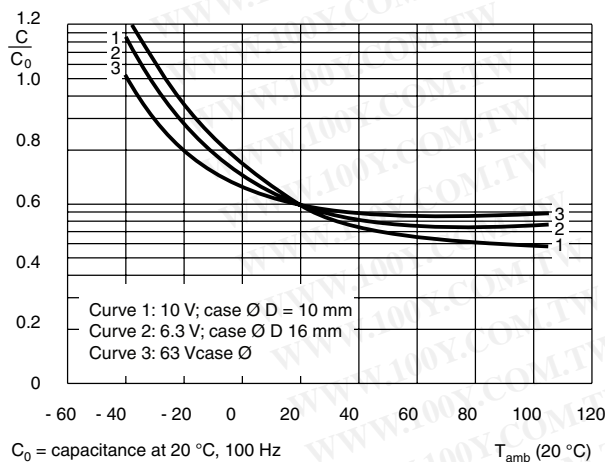


Fig.7 Typical multiplier of ESR as a function of ambient temperature

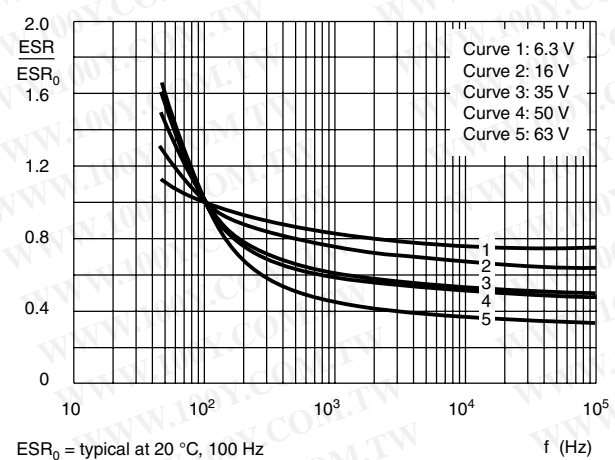


Fig.8 Typical multiplier of ESR as a function of frequency



IMPEDANCE (Z)

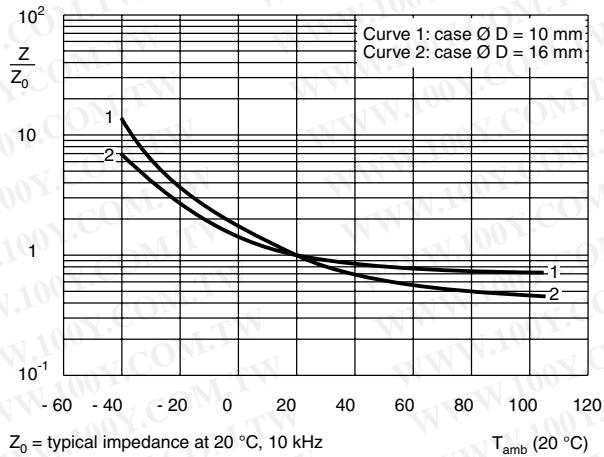


Fig.9 Typical multiplier of impedance as a function of ambient temperature

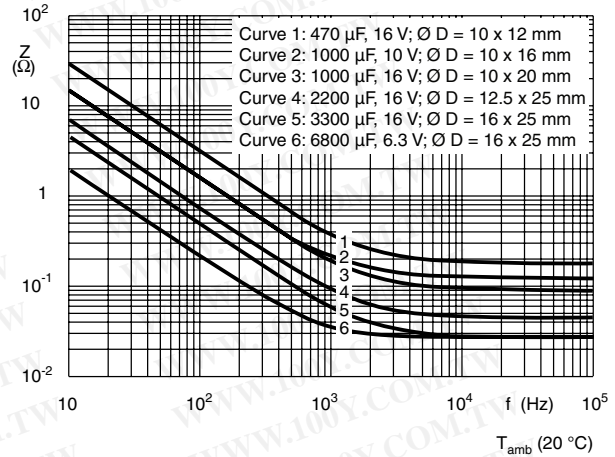


Fig.10 Typical impedance as a function of frequency

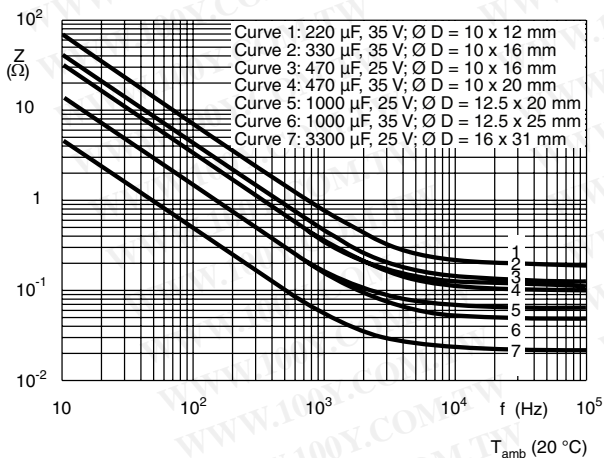


Fig.11 Typical impedance as a function of frequency

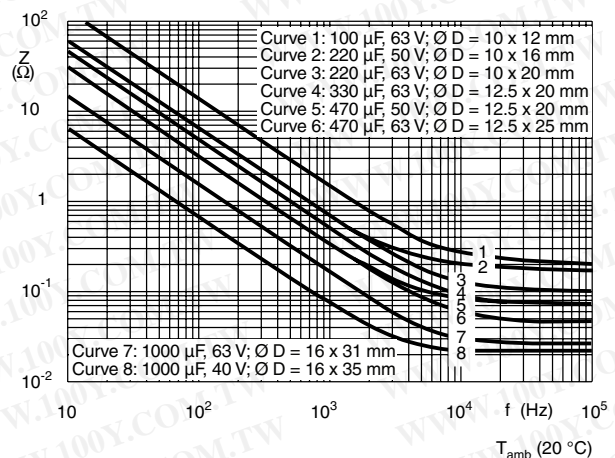


Fig.12 Typical impedance as a function of frequency

RIPPLE CURRENT AND USEFUL LIFE

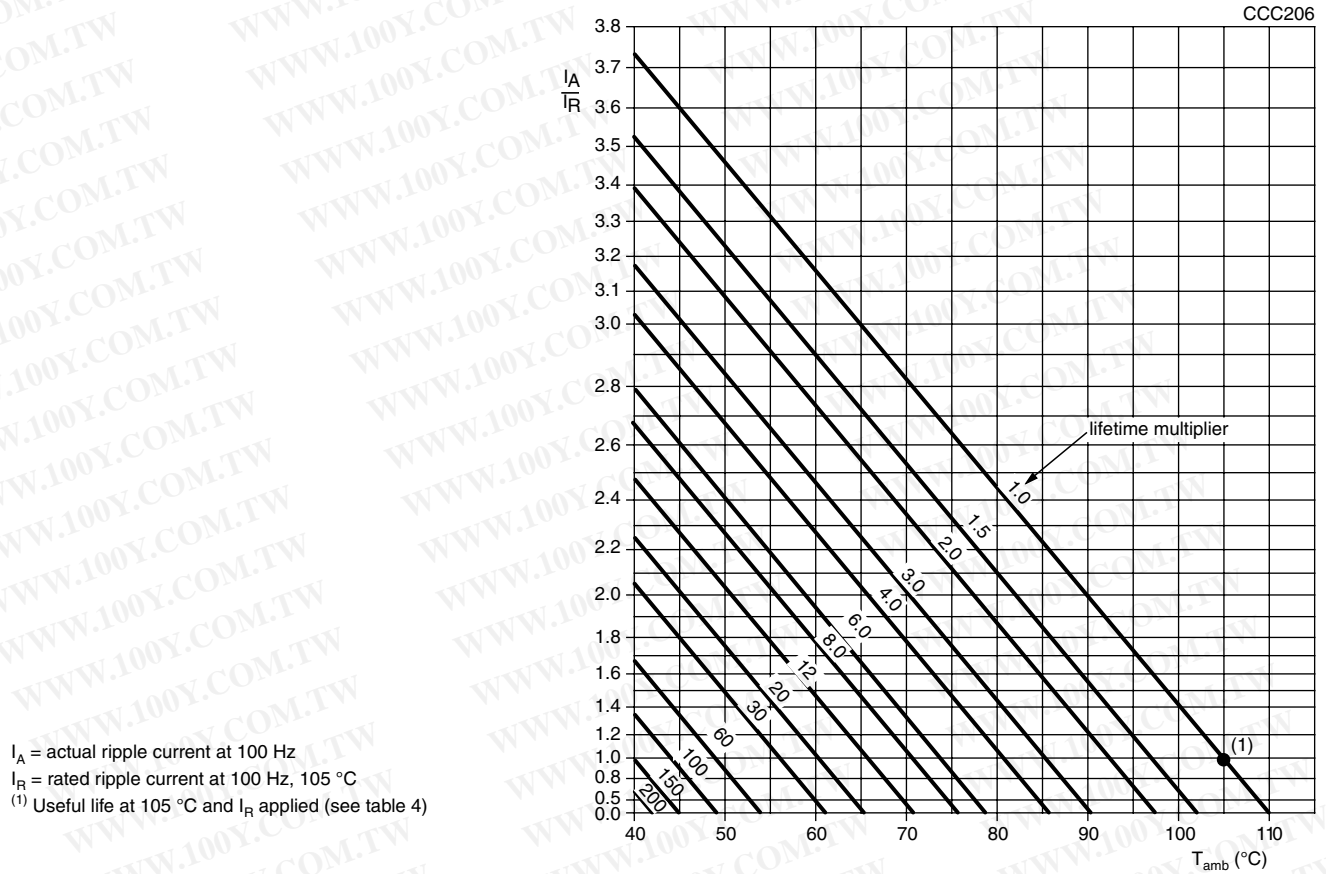


Fig.13 Multiplier of useful life as a function of ambient temperature and ripple current load

Table 3

MULTIPLIER OF RIPPLE CURRENT (I_R) AS A FUNCTION OF FREQUENCY			
FREQUENCY (Hz)	I_R MULTIPLIER		
	$U_R = 6.3$ to 25 V	$U_R = 35$ and 40 V	$U_R = 50$ and 63 V
50	0.95	0.85	0.80
100	1.00	1.00	1.00
300	1.07	1.20	1.25
1000	1.12	1.30	1.40
3000	1.15	1.35	1.50
$\geq 10\ 000$	1.20	1.40	1.60

TEST PROCEDURES AND REQUIREMENTS

TEST		PROCEDURE (quick reference)	REQUIREMENTS
NAME OF TEST	REFERENCE		
Endurance	IEC 60384-4/ EN130300 subclause 4.13	$T_{amb} = 105\text{ }^{\circ}\text{C}$; U_R applied; 2000 hours	$U_R \leq 6.3\text{ V}$; $\Delta C/C: +15/-30\%$ $U_R > 6.3\text{ V}$; $\Delta C/C: \pm 15\%$ $\tan \delta \leq 1.3 \times \text{spec. limit}$ $Z \leq 2 \times \text{spec. limit}$ $I_{L5} \leq \text{spec. limit}$
Useful life	CECC 30301 subclause 1.8.1	$T_{amb} = 105\text{ }^{\circ}\text{C}$; U_R and I_R applied; case $\varnothing D = 10$ and 12.5 mm : 3000 hours case $\varnothing D = 16$ and 18 mm : 4000 hours	$U_R \leq 6.3\text{ V}$; $\Delta C/C: +45/-50\%$ $U_R > 6.3\text{ V}$; $\Delta C/C: \pm 45\%$ $\tan \delta \leq 3 \times \text{spec. limit}$ $Z \leq 3 \times \text{spec. limit}$ $I_{L5} \leq \text{spec. limit}$ no short or open circuit total failure percentage: $\leq 1\%$
Shelf life (storage at high temperature)	IEC 60384-4/ EN130300 subclause 4.17	$T_{amb} = 105\text{ }^{\circ}\text{C}$; no voltage applied; 1000 hours after test: U_R to be applied for 30 minutes, 24 to 48 hours before measurement	$U_R \leq 6.3\text{ V}$; $\Delta C/C: +15/-30\%$ $U_R > 6.3\text{ V}$; $\Delta C/C: \pm 15\%$ $\tan \delta \leq 1.3 \times \text{spec. limit}$ $Z \leq 2 \times \text{spec. limit}$ $I_{L5} \leq 2 \times \text{spec. limit}$



Disclaimer

All product specifications and data are subject to change without notice.

Vishay Intertechnology, Inc., its affiliates, agents, and employees, and all persons acting on its or their behalf (collectively, "Vishay"), disclaim any and all liability for any errors, inaccuracies or incompleteness contained herein or in any other disclosure relating to any product.

Vishay disclaims any and all liability arising out of the use or application of any product described herein or of any information provided herein to the maximum extent permitted by law. The product specifications do not expand or otherwise modify Vishay's terms and conditions of purchase, including but not limited to the warranty expressed therein, which apply to these products.

No license, express or implied, by estoppel or otherwise, to any intellectual property rights is granted by this document or by any conduct of Vishay.

The products shown herein are not designed for use in medical, life-saving, or life-sustaining applications unless otherwise expressly indicated. Customers using or selling Vishay products not expressly indicated for use in such applications do so entirely at their own risk and agree to fully indemnify Vishay for any damages arising or resulting from such use or sale. Please contact authorized Vishay personnel to obtain written terms and conditions regarding products designed for such applications.

Product names and markings noted herein may be trademarks of their respective owners.