

Aluminum Capacitors Radial, High Temperature

勝特力材料 886-3-5753170
 勝特力电子(上海) 86-21-34970699
 勝特力电子(深圳) 86-755-83298787
[Http://www.100y.com.tw](http://www.100y.com.tw)

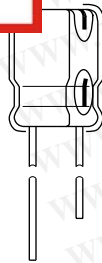
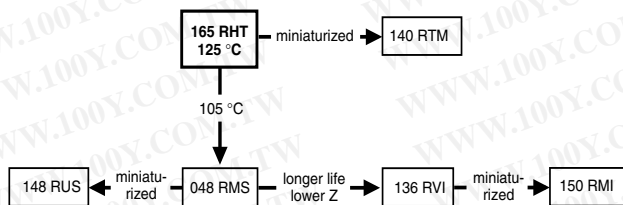

Fig.1 Component outline.



QUICK REFERENCE DATA	
DESCRIPTION	VALUE
Nominal case sizes (∅D × L in mm)	10 × 12 to 16 × 35
Rated capacitance range, C _R	22 to 4700 μF
Tolerance on C _R	± 20 %
Rated voltage range, U _R	10 to 50 V
Category temperature range	- 40 to + 125 °C
Endurance test at 125 °C	1 000 hours
Useful life at 125 °C	1500 hours
Useful life at 40 °C, 1.6 × I _R applied	300 000 hours
Shelf life at 0 V, 125 °C	500 hours
Based on sectional specification	IEC 60384-4/EN130300
Climatic category IEC 60068	40/125/56

SELECTION CHART FOR C _R , U _R AND RELEVANT NOMINAL CASE SIZES (∅D × L in mm)						
C _R (μF)	U _R (V)					
	10	16	25	35	40	50
22	-	-	-	-	-	10 × 12
47	-	-	-	-	10 × 12	10 × 16
100	-	-	10 × 12	10 × 16	10 × 20	12.5 × 20
220	10 × 12	10 × 16	10 × 20	-	12.5 × 20	16 × 25
470	10 × 20	12.5 × 20	12.5 × 25	16 × 25	16 × 31	16 × 35
1000	-	12.5 × 25	16 × 31	-	16 × 35	16 × 35
2200	16 × 31	16 × 35	16 × 35	-	-	-
3300	16 × 35	16 × 35	-	-	-	-
4700	16 × 35	-	-	-	-	-

* Pb containing terminations are not RoHS compliant, exemptions may apply

FEATURES

- Polarized aluminum electrolytic capacitors, non-solid electrolyte
- Radial leads, cylindrical aluminum case with pressure relief, insulated with a blue vinyl sleeve
- Charge and discharge proof
- Very long useful life: 1500 hours at 105 °C, high stability, high reliability
- Extended temperature range up to 125 °C
- High ripple current capability
- Lead (Pb)-Free versions are RoHS compliant

RoHS*
COMPLIANT

APPLICATIONS

- EDP, telecommunication, industrial, automotive and military
- Smoothing, filtering, buffering in SMPS
- High ambient temperature environments

MARKING

The capacitors are marked (where possible) with the following information:

- Rated capacitance (in μF)
- Tolerance on rated capacitance, code letter in accordance with IEC 60062 (M for ± 20 %)
- Rated voltage (in V)
- Date code, in accordance with IEC 60062
- Code indicating factory of origin
- Name of manufacturer
- Upper category temperature (125 °C)
- Negative terminal identification
- Series number (165)

DIMENSIONS in millimeters, AND AVAILABLE FORMS

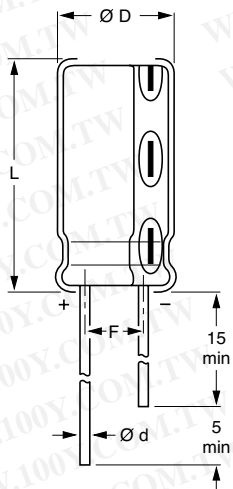

Fig.2 Form CA: Long leads.

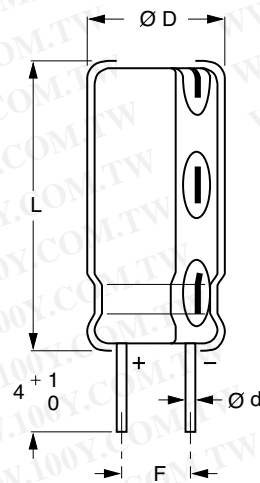
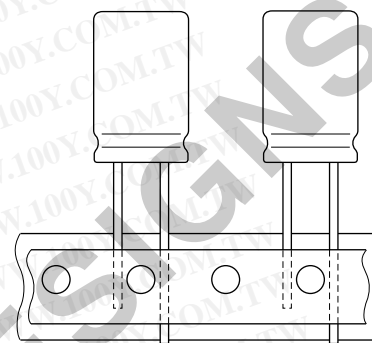

Fig.3 Form CB: Cut leads.



Case $\text{ØD} \times L \leq 16 \times 31$ mm.

Fig.4 Form TFA: Taped in box (ammopack).

Table 1

DIMENSIONS in millimeters, MASS AND PACKAGING QUANTITIES									
NOMINAL CASE SIZE $\text{ØD} \times L$	CASE CODE	ØD	ØD_{max}	L_{max}	F	MASS (g)	PACKAGING QUANTITIES PER BOX		
							FORM CA	FORM CB	FORM TFA
10 × 12	14	0.6	10.5	13.5	5.0 ± 0.5	≈ 1.6	1000	500	800
10 × 16	15	0.6	10.5	17.5	5.0 ± 0.5	≈ 1.9	500	500	800
10 × 20	16	0.6	10.5	22.0	5.0 ± 0.5	≈ 2.2	500	500	800
12.5 × 20	17	0.6	13.0	22.0	5.0 ± 0.5	≈ 4.0	500	500	500
12.5 × 25	18	0.6	13.0	27.0	5.0 ± 0.5	≈ 5.0	250	250	500
16 × 25	19	0.8	16.5	27.0	7.5 ± 0.5	≈ 8.0	250	250	250
16 × 31	20	0.8	16.5	33.5	7.5 ± 0.5	≈ 9.0	100	100	250
16 × 35	21	0.8	16.5	37.5	7.5 ± 0.5	≈ 11.5	100	100	–

Note

- Detailed tape dimensions see section 'PACKAGING'.



Aluminum Capacitors
Radial, High Temperature

Vishay BCcomponents

ELECTRICAL DATA	
SYMBOL	DESCRIPTION
C_R	rated capacitance at 100 Hz, tolerance $\pm 20\%$
I_R	rated RMS ripple current at 100 Hz, 125 °C
I_{L1}	max. leakage current after 1 minute at U_R
I_{L5}	max. leakage current after 5 minutes at U_R
$\tan \delta$	max. dissipation factor at 100 Hz
ESR	equivalent series resistance at 100 Hz (calculated from $\tan \delta_{max}$ and C_R)
Z	max. impedance at 10 kHz or 100 kHz

ORDERING EXAMPLE*

Electrolytic capacitor 165 series

220 μ F/25 V; $\pm 20\%$

Nominal case size: $\varnothing 10 \times 20$ mm; Form TFA

Catalog number: 2222 165 36221

* To ensure delivery of lead (Pb)-free parts during the transition period, please contact your Vishay sales agent.

Note

1. Unless otherwise specified, all electrical values in Table 2 apply at $T_{amb} = 20\text{ °C}$, $P = 86$ to 106 kPa, $RH = 45$ to 75% .

Table 2

ELECTRICAL DATA AND ORDERING INFORMATION													
U_R (V)	C_R 100 Hz (μ F)	NOMINAL CASE SIZE $\varnothing D \times L$ (mm)	CASE CODE	I_R 100 Hz 125 °C (mA)	I_{L1} 1 MIN (μ A)	I_{L5} 5 MIN (μ A)	TAN Δ 100 Hz	ESR 100 Hz (Ω)	Z 10 kHz (Ω)	Z 100 kHz (Ω)	CATALOG NUMBER 2222 165		
											BULK PACKAGING		TAPED
											FORM CA	FORM CB	FORM TFA
10	220	10 \times 12	14	200	25	7	0.20	1.30	–	0.55	165 54221	165 64221	165 34221
	470	10 \times 20	16	340	50	12	0.20	0.61	–	0.26	165 54471	165 64471	165 34471
	2200	16 \times 31	20	930	220	47	0.24	0.16	0.07	–	165 54222	165 64222	165 34222
	3300	16 \times 35	21	1200	330	69	0.26	0.11	0.05	–	165 54332	165 64332	–
	4700	16 \times 35	21	1400	470	97	0.28	0.09	0.04	–	165 90502	165 90507	–
16	220	10 \times 16	15	240	38	10	0.16	1.00	–	0.43	165 55221	165 65221	165 35221
	470	12.5 \times 20	17	410	78	18	0.16	0.49	–	0.20	165 55471	165 65471	165 35471
	1000	12.5 \times 25	18	650	160	35	0.16	0.23	–	0.10	165 55102	165 65102	165 35102
	2200	16 \times 35	21	1100	360	73	0.20	0.13	0.05	–	165 55222	165 65222	–
	3300	16 \times 35	21	1400	530	110	0.22	0.10	0.04	–	165 90503	165 90508	–
25	100	10 \times 12	14	170	28	8	0.14	2.00	–	0.70	165 56101	165 66101	165 36101
	220	10 \times 20	16	280	58	14	0.14	0.91	–	0.32	165 56221	165 66221	165 36221
	470	12.5 \times 25	18	480	120	27	0.14	0.43	–	0.15	165 56471	165 66471	165 36471
	1000	16 \times 31	20	830	250	53	0.14	0.20	–	0.07	165 56102	165 66102	165 36102
	2200	16 \times 35	21	1200	550	110	0.18	0.12	0.04	–	165 90504	165 90509	–
35	100	10 \times 16	15	200	38	10	0.12	1.70	–	0.65	165 50101	165 60101	165 30101
	470	16 \times 25	19	600	170	36	0.12	0.37	–	0.14	165 50471	165 60471	165 30471
40	47	10 \times 12	14	130	22	7	0.12	3.70	–	1.30	165 57479	165 67479	165 37479
	100	10 \times 20	16	210	43	11	0.12	1.70	–	0.60	165 57101	165 67101	165 37101
	220	12.5 \times 20	17	340	91	21	0.12	0.78	–	0.27	165 57221	165 67221	165 37221
	470	16 \times 31	20	650	190	41	0.12	0.37	–	0.13	165 57471	165 67471	165 37471
	1000	16 \times 35	21	1000	400	83	0.12	0.17	–	0.06	165 57102	165 67102	–
50	22	10 \times 12	14	100	14	5	0.10	6.50	–	2.3	165 51229	165 61229	165 31229
	47	10 \times 16	15	150	27	8	0.10	3.00	–	1.10	165 51479	165 61479	165 31479
	100	12.5 \times 20	17	260	53	13	0.10	1.40	–	0.50	165 51101	165 61101	165 31101
	220	16 \times 25	19	450	110	25	0.10	0.65	–	0.23	165 51221	165 61221	165 31221
	470	16 \times 35	21	760	240	50	0.10	0.30	–	0.11	165 51471	165 61471	–
1000	16 \times 35	21	1200	500	100	0.10	0.14	–	0.05	165 90506	165 90512	–	

ADDITIONAL ELECTRICAL DATA		
PARAMETER	CONDITIONS	VALUE
Voltage		
Surge voltage		$U_s \leq 1.3 U_R$
Reverse voltage		$U_{rev} \leq 1\text{ V}$
Current		
Leakage current	after 1 minute at U_R	$I_{L1} \leq 0.01 C_R \times U_R + 3\ \mu\text{A}$
	after 5 minutes at U_R	$I_{L5} \leq 0.002 C_R \times U_R + 3\ \mu\text{A}$
Inductance		
Equivalent series inductance (ESL)	case $\varnothing D = 10$ mm	typ. 16 nH
	case $\varnothing D \geq 12.5$ mm	typ. 18 nH

CAPACITANCE (C)

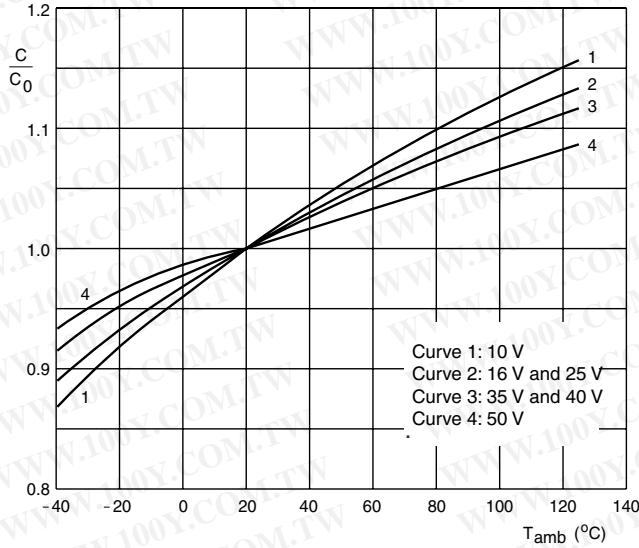

C_0 = capacitance at 20 °C

Fig.5 Typical multiplier of capacitance as a function of ambient temperature.

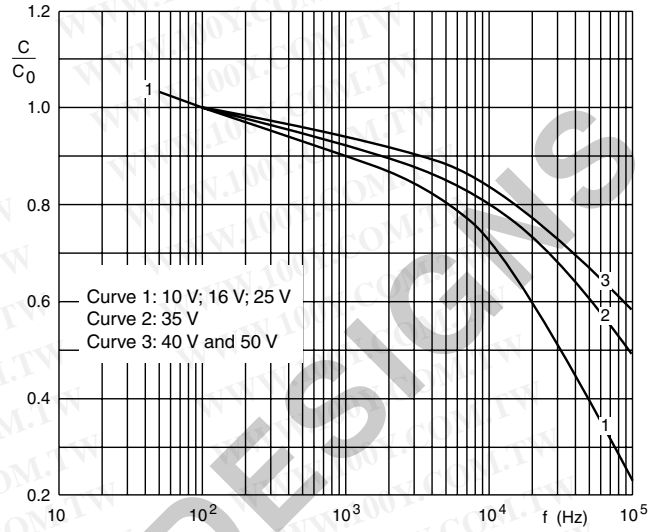

C_0 = capacitance at 20 °C, 100 Hz

$T_{amb} = 20$ °C.

Fig.6 Typical multiplier of capacitance as a function of frequency.

EQUIVALENT SERIES RESISTANCE (ESR)

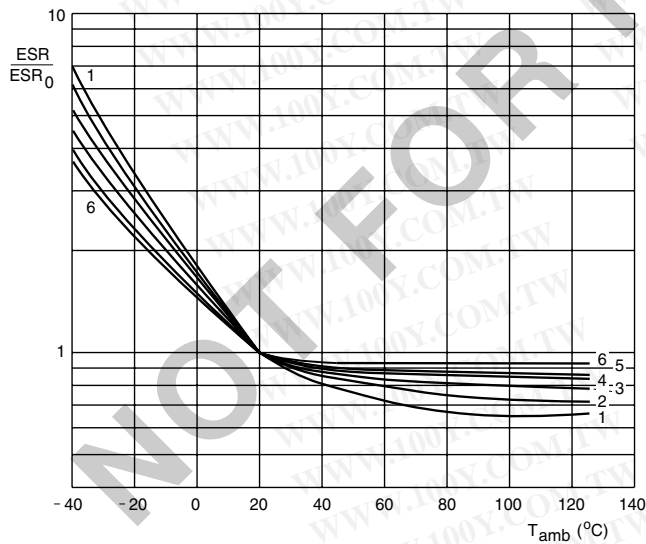

ESR_0 = typical at 20 °C

Fig.7 Typical multiplier of ESR as a function of ambient temperature.

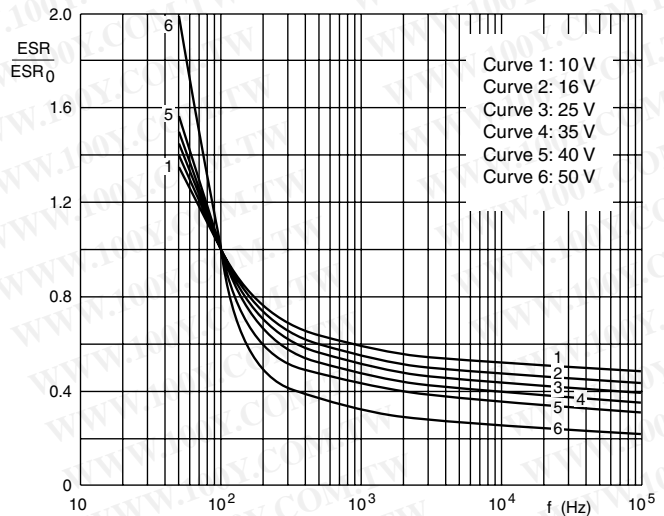

ESR_0 = typical at 20 °C, 100 Hz.

$T_{amb} = 20$ °C.

Fig.8 Typical multiplier of ESR as a function of frequency.



RIPPLE CURRENT AND USEFUL LIFE

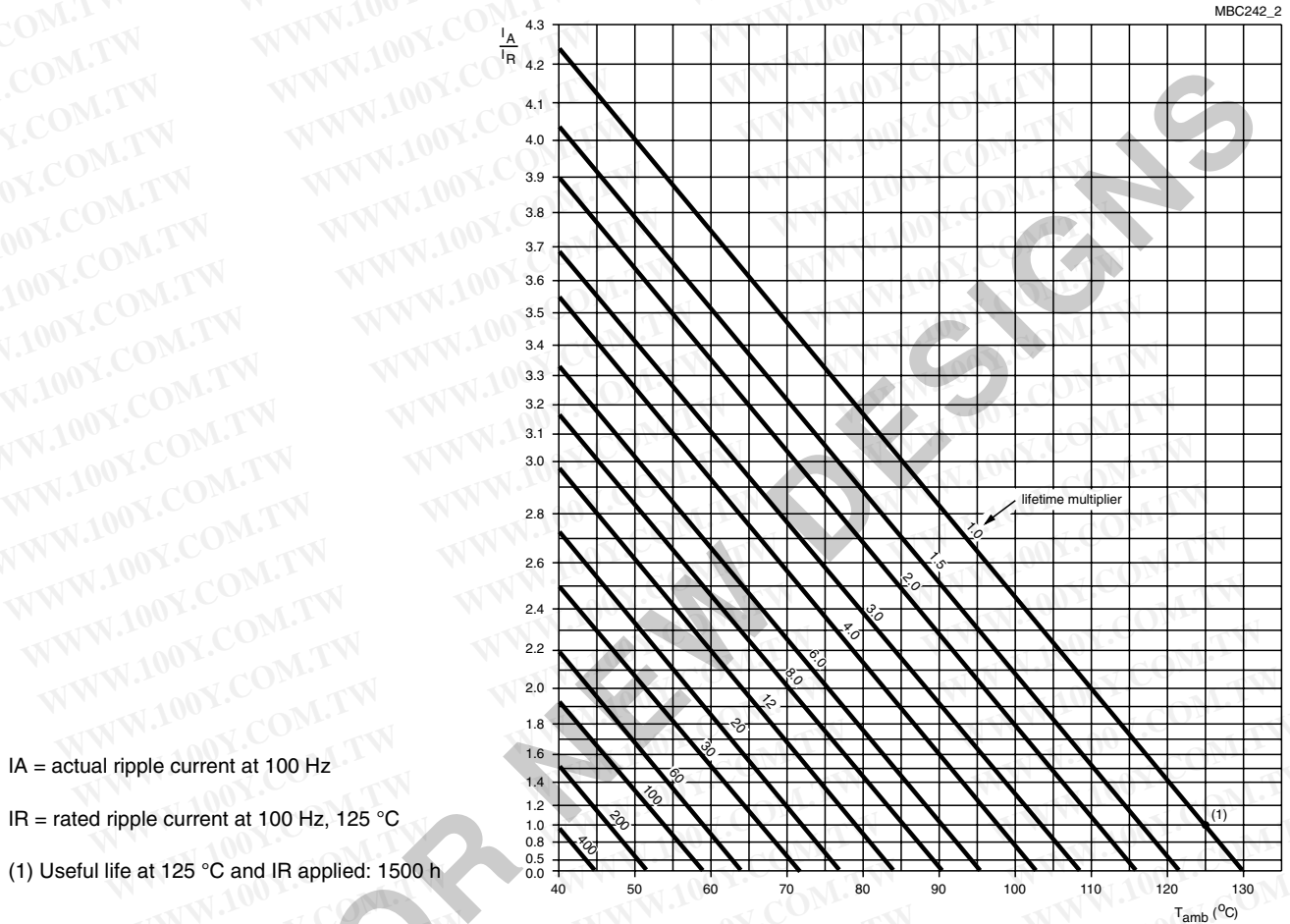

Fig.9 Multiplier of useful life as a function of ambient temperature and ripple current load.

Table 3

MULTIPLIER OF RIPPLE CURRENT (IR) AS A FUNCTION OF FREQUENCY			
FREQUENCY (Hz)	IR MULTIPLIER		
	UR = 10 to 25 V	UR = 35 or 40 V	UR = 50 V
50	0.85	0.80	0.75
100	1.00	1.00	1.00
300	1.20	1.25	1.30
1000	1.30	1.40	1.50
3000	1.35	1.50	1.65
≥ 10000	1.40	1.60	1.80



Table 4

TEST PROCEDURES AND REQUIREMENTS			
TEST		PROCEDURE (QUICK REFERENCE)	REQUIREMENTS
NAME OF TEST	REFERENCE		
Endurance	IEC 60384-4/ EN130300 subclause 4.13	$T_{amb} = 125\text{ °C}$; U_R applied; 1000 hours	$\Delta C/C: \pm 15\%$ $\tan \delta \leq 1.3 \times \text{spec. limit}$ $Z \leq 2 \times \text{spec. limit}$ $I_{L5} \leq \text{spec. limit}$
Useful life	GECC 30301 subclause 1.8.1	$T_{amb} = 125\text{ °C}$; U_R and I_R applied; 1500 hours	$\Delta C/C: \pm 45\%$ $\tan \delta \leq 3 \times \text{spec. limit}$ $Z \leq 3 \times \text{spec. limit}$ $I_{L5} \leq \text{spec. limit}$ no short or open circuit total failure percentage: $\leq 1\%$
Shelf life	IEC 60384-4/ EN130300 subclause 4.17	$T_{amb} = 125\text{ °C}$; no voltage applied; 500 hours after test: U_R to be applied for 30 minutes, 24 to 48 hours before measurement	$\Delta C/C: \pm 15\%$ $\tan \delta \leq 1.3 \times \text{spec. limit}$ $Z \leq 2 \times \text{spec. limit}$ $I_{L5} \leq 2 \times \text{spec. limit}$



Disclaimer

All product specifications and data are subject to change without notice.

Vishay Intertechnology, Inc., its affiliates, agents, and employees, and all persons acting on its or their behalf (collectively, "Vishay"), disclaim any and all liability for any errors, inaccuracies or incompleteness contained herein or in any other disclosure relating to any product.

Vishay disclaims any and all liability arising out of the use or application of any product described herein or of any information provided herein to the maximum extent permitted by law. The product specifications do not expand or otherwise modify Vishay's terms and conditions of purchase, including but not limited to the warranty expressed therein, which apply to these products.

No license, express or implied, by estoppel or otherwise, to any intellectual property rights is granted by this document or by any conduct of Vishay.

The products shown herein are not designed for use in medical, life-saving, or life-sustaining applications unless otherwise expressly indicated. Customers using or selling Vishay products not expressly indicated for use in such applications do so entirely at their own risk and agree to fully indemnify Vishay for any damages arising or resulting from such use or sale. Please contact authorized Vishay personnel to obtain written terms and conditions regarding products designed for such applications.

Product names and markings noted herein may be trademarks of their respective owners.

勝特力材料 886-3-5753170
勝特力电子(上海) 86-21-34970699
勝特力电子(深圳) 86-755-83298787
[Http://www.100y.com.tw](http://www.100y.com.tw)