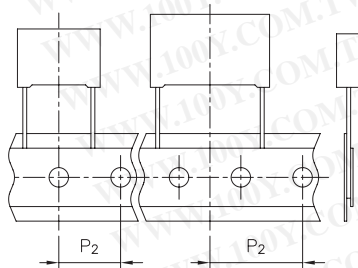

Fig. 1

Fig. 2

Loose

Taped



ød±0.05	15 ≤ p ≤ 27.5	p = 37.5
	0.8	1.0

All dimensions are in mm

PRODUCT CODE SYSTEM

The part number, comprising 14 digits, is formed as follows:



- Digit 1 to 3 Series code.
- Digit 4 d.c. rated voltage:
for 1 section
E = 100V G = 160V I = 250V
M = 400V
for 2 sections
P = 630V Q = 1000V R = 1250V
T = 1600V U = 2000V
- Digit 5 Pitch:
I = 15 mm; N = 22.5mm;
R = 27.5mm; W = 37.5mm.
- Digit 6 to 9 Digits 7 - 8 - 9 indicate the first three digits of Capacitance value and the 6th digit indicates the number of zeros that must be added to obtain the Rated Capacitance in pF.
- Digit 10 to 11 Mechanical version and/or packaging (table 1)
- Digit 12 Identifies the dimensions and electrical characteristics.
- Digit 13 Internal use.
- Digit 14 Capacitance tolerance:
H=2.5% (*); J=5%; K=10%
(* Only for 2 sections.

**FILM-FOIL POLYPROPYLENE CAPACITOR
HIGH CURRENT APPLICATIONS**

Typical applications: deflection circuits in TV-sets (fly-back tuning), switching spikes suppression in SMPS, SNUBBER and SCR commutating circuits, switching circuit in electronic ballasts, applications with high voltage and very high current.

PRODUCT CODE: R73

PLEASE USE SERIES R76 OR R77 INSTEAD

Pitch (mm)	Box thickness (mm)	Maximum dimensions (mm)		
		B max	H max	L max
15.0	<7.5	B +0.2	H +0.1	L +0.3
15.0	≥7.5	B +0.2	H +0.1	L +0.5
22.5	All	B +0.2	H +0.1	L +0.3
27.5	All	B +0.2	H +0.1	L +0.3
37.5	All	B +0.3	H +0.1	L +0.3

GENERAL TECHNICAL DATA

- Dielectric:** polypropylene film.
- Plates:** metal foil for 1 section.
metal foil + metallized film for 2 sections.
- Winding:** non-inductive type.
- Leads:** tinned wire.
- Protection:** plastic case, thermosetting resin filled.
Box material is solvent resistant and flame retardant according to UL94 V0.
- Marking:** capacitance, tolerance, D.C. rated voltage, manufacturer's logo, series (R73), dielectric code (KP), manufacturing date code.
- Climatic category:** 55/105/56 IEC 60068-1
- Operating temperature range:** -55 to +105°C
- Related documents:** IEC 60384-13

Table 1 (for more detailed information, please refer to page 14.)

Standard packaging style	Lead length (mm)	Taping style		Ordering code (Digit 10 to 11)
		P ₂ (mm)	Fig. (No.)	
AMMO-PACK		12.70	1	DQ
AMMO-PACK		19.05	2	DQ
REEL Ø 355mm		12.70	1	GY
REEL Ø 500mm		12.70	1	CK
REEL Ø 500mm		19.05	2	CK
Loose, short leads	4 ⁺²			SE
Loose, long leads	30 ⁺⁵			40
Loose, long leads	25 ^{+2/-1}			50

Note: Ammo-pack is the preferred packaging for taped version.

**FILM-FOIL POLYPROPYLENE CAPACITOR
HIGH CURRENT APPLICATIONS**

PRODUCT CODE: **R73**

Rated Cap.	100Vdc / 63Vac Std dimensions				Max dv/dt (V/μs)	Max K ₀ (V ² /μs)	Part Number
	B	H	L	p			
0.047 μF	5.0	11.0	18.0	15.0	2400	0.48 E6	R73EI 2470--0--
0.068 μF	6.0	12.0	18.0	15.0	2400	0.48 E6	R73EI 2680--0--
0.10 μF	7.5	13.5	18.0	15.0	2400	0.48 E6	R73EI 3100--0--
0.15 μF	10.0	16.0	18.0	15.0	2400	0.48 E6	R73EI 3150--0--

Rated Cap.	160Vdc / 90Vac Std dimensions				Max dv/dt (V/μs)	Max K ₀ (V ² /μs)	Part Number
	B	H	L	p			
0.033 μF	5.0	11.0	18.0	15.0	3000	0.96 E6	R73GI 2330--0--
0.047 μF	6.0	12.0	18.0	15.0	3000	0.96 E6	R73GI 2470--0--
0.068 μF	7.5	13.5	18.0	15.0	3000	0.96 E6	R73GI 2680--0--
0.10 μF	10.0	16.0	18.0	15.0	3000	0.96 E6	R73GI 3100--0--

Rated Cap.	250Vdc / 125Vac* Std dimensions				Max dv/dt (V/μs)	Max K ₀ (V ² /μs)	Part Number
	B	H	L	p			
0.015 μF	5.0	11.0	18.0	15.0	4800	2.4 E6	R73II 2150--0--
0.022 μF	6.0	12.0	18.0	15.0	4800	2.4 E6	R73II 2220--0--
0.033 μF	7.5	13.5	18.0	15.0	4800	2.4 E6	R73II 2330--0--
0.047 μF	10.0	16.0	18.0	15.0	4800	2.4 E6	R73II 2470--0--

Rated Cap.	400Vdc / 160Vac Std dimensions				Max dv/dt (V/μs)	Max K ₀ (V ² /μs)	Part Number
	B	H	L	p			
0.010 μF	5.0	11.0	18.0	15.0	6000	4.8 E6	R73MI 2100--0--
0.015 μF	6.0	12.0	18.0	15.0	6000	4.8 E6	R73MI 2150--0--
0.022 μF	7.5	13.5	18.0	15.0	6000	4.8 E6	R73MI 2220--0--
0.033 μF	8.5	14.5	18.0	15.0	6000	4.8 E6	R73MI 2330--0--
0.047 μF	10.0	16.0	18.0	15.0	6000	4.8 E6	R73MI 2470--0--

Mechanical version and packaging (Table1) _____
 Internal use _____
 Tolerance: J (±5%); K (±10%) _____

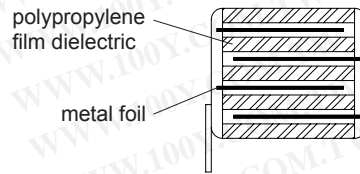

**1 section
(100-160-250-400Vdc)**

All dimensions are in mm.

Note: If the working voltage (V) is lower than the rated voltage (V_R), the capacitor may work at higher dv/dt. In this case the maximum value allowed is obtained multiplying the above value (see table dv/dt) with the ratio V_R/V. The pulse characteristic K₀ depends on the voltage wave-form and in any case it cannot overcome the value given in the above table. The dv/dt test is carried out at 2 times the above values.

*Not suitable for across-the-line applications. Please refer to Interference Suppression Capacitors (page 145).

**FILM-FOIL POLYPROPYLENE CAPACITOR
HIGH CURRENT APPLICATIONS**

PRODUCT CODE: R73

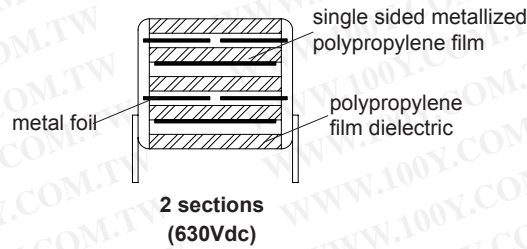

Rated Cap.	630Vdc / 300Vac* Std dimensions				Max dv/dt (V/μs)	Max K ₀ (V ² /μs)	Part Number
	B	H	L	p			
0.010 μF	5.0	11.0	18.0	15.0	11000	14.0 E6	R73PI 2100--0--
0.012 μF	5.0	11.0	18.0	15.0	11000	14.0 E6	R73PI 2120--0--
0.015 μF	6.0	12.0	18.0	15.0	11000	14.0 E6	R73PI 2150--0--
0.018 μF	6.0	12.0	18.0	15.0	11000	14.0 E6	R73PI 2180--0--
0.022 μF	7.5	13.5	18.0	15.0	11000	14.0 E6	R73PI 2220--0--
0.027 μF	7.5	13.5	18.0	15.0	11000	14.0 E6	R73PI 2270--0--
0.033 μF	8.5	14.5	18.0	15.0	11000	14.0 E6	R73PI 2330--0--
0.039 μF	10.0	16.0	18.0	15.0	11000	14.0 E6	R73PI 2390--0--
0.047 μF	10.0	16.0	18.0	15.0	11000	14.0 E6	R73PI 2470--0--
0.039 μF	6.0	15.0	26.5	22.5	11000	14.0 E6	R73PN 2390--0--
0.047 μF	7.0	16.0	26.5	22.5	11000	14.0 E6	R73PN 2470--0--
0.056 μF	7.0	16.0	26.5	22.5	11000	14.0 E6	R73PN 2560--0--
0.068 μF	8.5	17.0	26.5	22.5	11000	14.0 E6	R73PN 2680--0--
0.082 μF	10.0	18.5	26.5	22.5	11000	14.0 E6	R73PN 2820--0--
0.10 μF	10.0	18.5	26.5	22.5	11000	14.0 E6	R73PN 3100--0--
0.10 μF	9.0	17.0	32.0	27.5	11000	14.0 E6	R73PR 3100--0--
0.12 μF	9.0	17.0	32.0	27.5	11000	14.0 E6	R73PR 3120--0--
0.15 μF	11.0	20.0	32.0	27.5	11000	14.0 E6	R73PR 3150--0--
0.18 μF	11.0	20.0	32.0	27.5	11000	14.0 E6	R73PR 3180--1--
0.18 μF	13.0	22.0	32.0	27.5	11000	14.0 E6	R73PR 3180--0--
0.22 μF	13.0	22.0	32.0	27.5	11000	14.0 E6	R73PR 3220--0--
0.27 μF	13.0	25.0	32.0	27.5	11000	14.0 E6	R73PR 3270--1--
0.33 μF	14.0	28.0	32.0	27.5	11000	14.0 E6	R73PR 3330--0--
0.39 μF	14.0	28.0	32.0	27.5	11000	14.0 E6	R73PR 3390--1--
0.39 μF	18.0	33.0	32.0	27.5	11000	14.0 E6	R73PR 3390--0--
0.47 μF	18.0	33.0	32.0	27.5	11000	14.0 E6	R73PR 3470--0--
0.56 μF	18.0	33.0	32.0	27.5	11000	14.0 E6	R73PR 3560--1--
0.56 μF	22.0	37.0	32.0	27.5	11000	14.0 E6	R73PR 3560--0--
0.68 μF	22.0	37.0	32.0	27.5	11000	14.0 E6	R73PR 3680--0--
0.82 μF	22.0	37.0	32.0	27.5	11000	14.0 E6	R73PR 3820--1--

Rated Cap.	630Vdc / 300Vac* Std dimensions				Max dv/dt (V/μs)	Max K ₀ (V ² /μs)	Part Number
	B	H	L	p			
0.22 μF	11.0	22.0	41.5	37.5	3000	3.8 E6	R73PW3220--0--
0.27 μF	11.0	22.0	41.5	37.5	3000	3.8 E6	R73PW3270--0--
0.33 μF	11.0	22.0	41.5	37.5	3000	3.8 E6	R73PW3330--1--
0.33 μF	13.0	24.0	41.5	37.5	3000	3.8 E6	R73PW3330--0--
0.39 μF	13.0	24.0	41.5	37.5	3000	3.8 E6	R73PW3390--0--
0.47 μF	13.0	24.0	41.5	37.5	3000	3.8 E6	R73PW3470--1--
0.47 μF	16.0	28.5	41.5	37.5	3000	3.8 E6	R73PW3470--0--
0.56 μF	16.0	28.5	41.5	37.5	3000	3.8 E6	R73PW3560--0--
0.68 μF	16.0	28.5	41.5	37.5	3000	3.8 E6	R73PW3680--0--
0.82 μF	19.0	32.0	41.5	37.5	3000	3.8 E6	R73PW3820--0--
1.0 μF	20.0	40.0	41.5	37.5	3000	3.8 E6	R73PW4100--0--
1.2 μF	20.0	40.0	41.5	37.5	3000	3.8 E6	R73PW4120--0--
1.5 μF	24.0	44.0	41.5	37.5	3000	3.8 E6	R73PW4150--0--
1.8 μF	30.0	45.0	41.5	37.5	3000	3.8 E6	R73PW4180--0--
2.2 μF	30.0	45.0	41.5	37.5	3000	3.8 E6	R73PW4220--0--

Mechanical version and packaging (Table1) _____
Internal use _____
Tolerance: J (±5%); K (±10%); _____

Mechanical version and packaging (Table1) _____
Internal use _____
Tolerance: J (±5%); K (±10%); _____

All dimensions are in mm.

Note: If the working voltage (V) is lower than the rated voltage (V_R), the capacitor may work at higher dv/dt. In this case the maximum value allowed is obtained multiplying the above value (see table dv/dt) with the ratio V_R/V. The pulse characteristic K₀ depends on the voltage wave-form and in any case it cannot overcome the value given in the above table. The dv/dt test is carried out at 2 times the above values.

*Not suitable for cross-the-line applications. Please refer to Interference Suppression Capacitors (page 145).

**FILM-FOIL POLYPROPYLENE CAPACITOR
HIGH CURRENT APPLICATIONS.**

PRODUCT CODE: **R73**

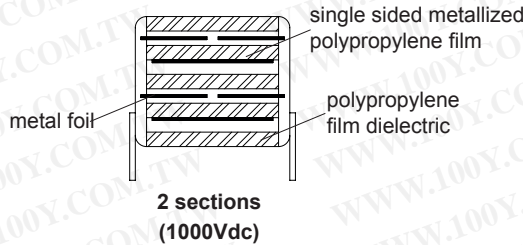

Rated Cap.	1000Vdc / 400Vac Std dimensions				Max dv/dt (V/μs)	K ₀ (V ² /μs)	Part Number
	B	H	L	p			
3300 pF	5.0	11.0	18.0	15.0	28000	56 E6	R73QI 1330--3--
3900 pF	5.0	11.0	18.0	15.0	28000	56 E6	R73QI 1390--3--
4700 pF	5.0	11.0	18.0	15.0	28000	56 E6	R73QI 1470--3--
5600 pF	5.0	11.0	18.0	15.0	28000	56 E6	R73QI 1560--3--
6800 pF	5.0	11.0	18.0	15.0	28000	56 E6	R73QI 1680--3--
8200 pF	5.0	11.0	18.0	15.0	28000	56 E6	R73QI 1820--3--
0.010 μF	6.0	12.0	18.0	15.0	28000	56 E6	R73QI 2100--3--
0.012 μF	6.0	12.0	18.0	15.0	28000	56 E6	R73QI 2120--3--
0.015 μF	7.5	13.5	18.0	15.0	28000	56 E6	R73QI 2150--3--
0.018 μF	8.5	14.5	18.0	15.0	28000	56 E6	R73QI 2180--3--
0.022 μF	8.5	14.5	18.0	15.0	28000	56 E6	R73QI 2220--3--
0.027 μF	10.0	16.0	18.0	15.0	28000	56 E6	R73QI 2270--3--
0.015 μF	6.0	15.0	26.5	22.5	11000	22 E6	R73QN 2150--3--
0.018 μF	6.0	15.0	26.5	22.5	11000	22 E6	R73QN 2180--3--
0.022 μF	6.0	15.0	26.5	22.5	11000	22 E6	R73QN 2220--3--
0.027 μF	7.0	16.0	26.5	22.5	11000	22 E6	R73QN 2270--3--
0.033 μF	7.0	16.0	26.5	22.5	11000	22 E6	R73QN 2330--3--
0.039 μF	8.5	17.0	26.5	22.5	11000	22 E6	R73QN 2390--3--
0.047 μF	8.5	17.0	26.5	22.5	11000	22 E6	R73QN 2470--3--
0.056 μF	10.0	18.5	26.5	22.5	11000	22 E6	R73QN 2560--3--
0.068 μF	11.0	20.0	26.5	22.5	11000	22 E6	R73QN 2680--3--
0.047 μF	9.0	17.0	32.0	27.5	11000	22 E6	R73QR 2470--3--
0.056 μF	9.0	17.0	32.0	27.5	11000	22 E6	R73QR 2560--3--
0.068 μF	9.0	17.0	32.0	27.5	11000	22 E6	R73QR 2680--3--
0.082 μF	9.0	17.0	32.0	27.5	11000	22 E6	R73QR 2820--4--
0.082 μF	11.0	20.0	32.0	27.5	11000	22 e6	R73QR 2820--3--
0.10 μF	11.0	20.0	32.0	27.5	11000	22 E6	R73QR 3100--3--
0.12 μF	11.0	20.0	32.0	27.5	11000	22 E6	R73QR 3120--4--
0.12 μF	13.0	22.0	32.0	27.5	11000	22 E6	R73QR 3120--3--
0.15 μF	13.0	22.0	32.0	27.5	11000	22 E6	R73QR 3150--3--
0.18 μF	13.0	25.0	32.0	27.5	11000	22 E6	R73QR 3180--4--
0.22 μF	14.0	28.0	32.0	27.5	11000	22 E6	R73QR 3220--3--
0.27 μF	18.0	33.0	32.0	27.5	11000	22 E6	R73QR 3270--3--
0.33 μF	18.0	33.0	32.0	27.5	11000	22 E6	R73QR 3330--3--
0.47 μF	22.0	37.0	32.0	27.5	11000	22 E6	R73QR 3470--3--

Rated Cap.	1000Vdc / 400Vac Std dimensions				Max dv/dt (V/μs)	K ₀ (V ² /μs)	Part Number
	B	H	L	p			
0.12 μF	11.0	22.0	41.5	37.5	4500	9 E6	R73QW3120--3--
0.15 μF	11.0	22.0	41.5	37.5	4500	9 E6	R73QW3150--3--
0.18 μF	11.0	22.0	41.5	37.5	4500	9 E6	R73QW3180--3--
0.22 μF	13.0	24.0	41.5	37.5	4500	9 E6	R73QW3220--3--
0.27 μF	13.0	24.0	41.5	37.5	4500	9 E6	R73QW3270--4--
0.27 μF	16.0	28.5	41.5	37.5	4500	9 E6	R73QW3270--3--
0.33 μF	16.0	28.5	41.5	37.5	4500	9 E6	R73QW3330--3--
0.39 μF	16.0	28.5	41.5	37.5	4500	9 E6	R73QW3390--3--
0.47 μF	19.0	32.0	41.5	37.5	4500	9 E6	R73QW3470--3--
0.56 μF	19.0	32.0	41.5	37.5	4500	9 E6	R73QW3560--3--
0.68 μF	20.0	40.0	41.5	37.5	4500	9 E6	R73QW3680--3--
0.82 μF	20.0	40.0	41.5	37.5	4500	9 E6	R73QW3820--3--
1.0 μF	24.0	44.0	41.5	37.5	4500	9 E6	R73QW4100--3--
1.2 μF	30.0	45.0	41.5	37.5	4500	9 E6	R73QW4120--3--
1.5 μF	30.0	45.0	41.5	37.5	4500	9 E6	R73QW4150--4--

Mechanical version and packaging (Table1) _____
 Internal use _____
 Tolerance: H (±2.5%); J (±5%); K (±10%); _____

Mechanical version and packaging (Table1) _____
 Internal use _____
 Tolerance: H (±2.5%); J (±5%); K (±10%); _____

All dimensions are in mm.

Note: If the working voltage (V) is lower than the rated voltage (V_R), the capacitor may work at higher dv/dt. In this case the maximum value allowed is obtained multiplying the above value (see table dv/dt) with the ratio V_R/V.
 The pulse characteristic K₀ depends on the voltage wave-form and in any case it cannot overcome the value given in the above table. The dv/dt test is carried out at 2 times the above values.

FILM-FOIL POLYPROPYLENE CAPACITOR
HIGH CURRENT APPLICATIONS.

PRODUCT CODE: R73

勝特力材料 886-3-5753170
勝特力电子(上海) 86-21-34970699
勝特力电子(深圳) 86-755-83298787
[Http://www.100y.com.tw](http://www.100y.com.tw)

Rated Cap.	1250Vdc / 450Vac Std dimensions				Max dv/dt (V/μs)	K ₀ (V ² /μs)	Part Number
	B	H	L	p			
2200 pF	5.0	11.0	18.0	15.0	30000	75 E6	R73RI 1220--0--
2700 pF	5.0	11.0	18.0	15.0	30000	75 E6	R73RI 1270--0--
3300 pF	6.0	12.0	18.0	15.0	30000	75 E6	R73RI 1330--0--
3900 pF	6.0	12.0	18.0	15.0	30000	75 E6	R73RI 1390--0--
4700 pF	7.5	13.5	18.0	15.0	30000	75 E6	R73RI 1470--0--
5600 pF	7.5	13.5	18.0	15.0	30000	75 E6	R73RI 1560--0--
6800 pF	8.5	14.5	18.0	15.0	30000	75 E6	R73RI 1680--0--
8200 pF	10.0	16.0	18.0	15.0	30000	75 E6	R73RI 1820--0--
8200 pF	6.0	15.0	26.5	22.5	11000	27 E6	R73RN 1820--0--
0.010 μF	6.0	15.0	26.5	22.5	11000	27 E6	R73RN 2100--0--
0.012 μF	6.0	15.0	26.5	22.5	11000	27 E6	R73RN 2120--0--
0.015 μF	7.0	16.0	26.5	22.5	11000	27 E6	R73RN 2150--0--
0.018 μF	7.0	16.0	26.5	22.5	11000	27 E6	R73RN 2180--0--
0.022 μF	8.5	17.0	26.5	22.5	11000	27 E6	R73RN 2220--0--
0.027 μF	10.0	18.5	26.5	22.5	11000	27 E6	R73RN 2270--0--
0.033 μF	10.0	18.5	26.5	22.5	11000	27 E6	R73RN 2330--0--
0.039 μF	9.0	17.0	32.0	27.5	11000	27 E6	R73RR 2390--0--
0.047 μF	11.0	20.0	32.0	27.5	11000	27 E6	R73RR 2470--0--
0.056 μF	11.0	20.0	32.0	27.5	11000	27 E6	R73RR 2560--0--
0.068 μF	13.0	22.0	32.0	27.5	11000	27 E6	R73RR 2680--0--
0.082 μF	13.0	25.0	32.0	27.5	11000	27 E6	R73RR 2820--1--
0.10 μF	13.0	25.0	32.0	27.5	11000	27 E6	R73RR 3100--1--
0.12 μF	14.0	28.0	32.0	27.5	11000	27 E6	R73RR 3120--1--
0.12 μF	18.0	33.0	32.0	27.5	11000	27 E6	R73RR 3120--0--
0.15 μF	18.0	33.0	32.0	27.5	11000	27 E6	R73RR 3150--0--
0.18 μF	18.0	33.0	32.0	27.5	11000	27 E6	R73RR 3180--0--
0.22 μF	22.0	37.0	32.0	27.5	11000	27 E6	R73RR 3220--0--
0.082 μF	11.0	22.0	41.5	37.5	5500	14 E6	R73RW2820--0--
0.10 μF	11.0	22.0	41.5	37.5	5500	14 E6	R73RW3100--0--
0.12 μF	11.0	22.0	41.5	37.5	5500	14 E6	R73RW3120--1--
0.12 μF	13.0	24.0	41.5	37.5	5500	14 E6	R73RW3120--0--
0.15 μF	13.0	24.0	41.5	37.5	5500	14 E6	R73RW3150--0--
0.18 μF	13.0	24.0	41.5	37.5	5500	14 E6	R73RW3180--1--
0.18 μF	16.0	28.5	41.5	37.5	5500	14 E6	R73RW3180--0--
0.22 μF	16.0	28.5	41.5	37.5	5500	14 E6	R73RW3220--0--
0.27 μF	16.0	28.5	41.5	37.5	5500	14 E6	R73RW3270--0--
0.33 μF	19.0	32.0	41.5	37.5	5500	14 E6	R73RW3330--0--
0.39 μF	20.0	40.0	41.5	37.5	5500	14 E6	R73RW3390--0--
0.47 μF	20.0	40.0	41.5	37.5	5500	14 E6	R73RW3470--0--
0.56 μF	20.0	40.0	41.5	37.5	5500	14 E6	R73RW3560--0--
0.68 μF	24.0	44.0	41.5	37.5	5500	14 E6	R73RW3680--0--
0.82 μF	30.0	45.0	41.5	37.5	5500	14 E6	R73RW3820--0--

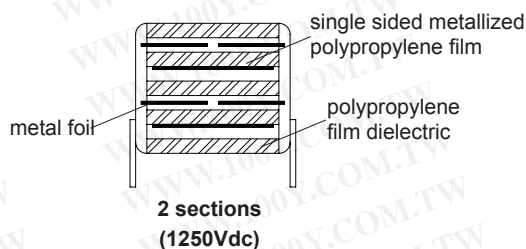

All dimensions are in mm.

Note: If the working voltage (V) is lower than the rated voltage (V_R), the capacitor may work at higher dv/dt. In this case the maximum value allowed is obtained multiplying the above value (see table dv/dt) with the ratio V_R/V.

The pulse characteristic K₀ depends on the voltage wave-form and in any case it cannot overcome the value given in the above table. The dv/dt test is carried out at 2 times the above values.

Mechanical version and packaging (Table1)
Internal use _____
Tolerance: H (±2.5%); J (±5%); K (±10%); _____

**FILM-FOIL POLYPROPYLENE CAPACITOR
HIGH CURRENT APPLICATIONS**

PRODUCT CODE: **R73**

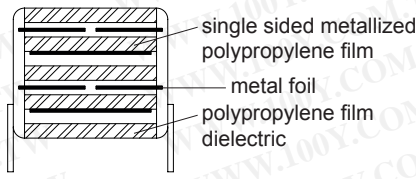

**2 sections
(1600Vdc)**

Rated Cap.	1600Vdc / 450Vac Std dimensions				Max dv/dt (V/μs)	Max K ₀ (V ² /μs)	Part Number
	B	H	L	p			
1000 pF	5.0	11.0	18.0	15.0	34000	109 E6	R73TI 1100--0--
1200 pF	5.0	11.0	18.0	15.0	34000	109 E6	R73TI 1120--0--
1500 pF	5.0	11.0	18.0	15.0	34000	109 E6	R73TI 1150--0--
1800 pF	5.0	11.0	18.0	15.0	34000	109 E6	R73TI 1180--0--
2200 pF	6.0	12.0	18.0	15.0	34000	109 E6	R73TI 1220--0--
2700 pF	6.0	12.0	18.0	15.0	34000	109 E6	R73TI 1270--0--
3300 pF	7.5	13.5	18.0	15.0	34000	109 E6	R73TI 1330--0--
3900 pF	7.5	13.5	18.0	15.0	34000	109 E6	R73TI 1390--0--
4700 pF	8.5	14.5	18.0	15.0	34000	109 E6	R73TI 1470--0--
5600 pF	10.0	16.0	18.0	15.0	34000	109 E6	R73TI 1560--0--
6800 pF	10.0	16.0	18.0	15.0	34000	109 E6	R73TI 1680--0--
5600 pF	6.0	15.0	26.5	22.5	11000	35 E6	R73TN 1560--0--
6800 pF	6.0	15.0	26.5	22.5	11000	35 E6	R73TN 1680--0--
8200 pF	6.0	15.0	26.5	22.5	11000	35 E6	R73TN 1820--0--
0.010 μF	6.0	15.0	26.5	22.5	11000	35 E6	R73TN 2100--0--
0.012 μF	7.0	16.0	26.5	22.5	11000	35 E6	R73TN 2120--0--
0.015 μF	8.5	17.0	26.5	22.5	11000	35 E6	R73TN 2150--0--
0.018 μF	8.5	17.0	26.5	22.5	11000	35 E6	R73TN 2180--0--
0.022 μF	10.0	18.5	26.5	22.5	11000	35 E6	R73TN 2220--0--
0.027 μF	9.0	17.0	32.0	27.5	11000	35 E6	R73TR 2270--0--
0.033 μF	11.0	20.0	32.0	27.5	11000	35 E6	R73TR 2330--0--
0.039 μF	11.0	20.0	32.0	27.5	11000	35 E6	R73TR 2390--0--
0.047 μF	13.0	22.0	32.0	27.5	11000	35 E6	R73TR 2470--0--
0.056 μF	13.0	22.0	32.0	27.5	11000	35 E6	R73TR 2560--0--
0.068 μF	14.0	28.0	32.0	27.5	11000	35 E6	R73TR 2680--1--
0.082 μF	14.0	28.0	32.0	27.5	11000	35 E6	R73TR 2820--0--
0.10 μF	18.0	33.0	32.0	27.5	11000	35 E6	R73TR 3100--0--
0.12 μF	18.0	33.0	32.0	27.5	11000	35 E6	R73TR 3120--0--
0.15 μF	22.0	37.0	32.0	27.5	11000	35 E6	R73TR 3150--0--
0.18 μF	22.0	37.0	32.0	27.5	11000	35 E6	R73TR 3180--0--

Mechanical version and packaging (Table1) _____
Internal use _____
Tolerance: H (±2.5%); J (±5%); K (±10%) _____

Rated Cap.	1600Vdc / 450Vac Std dimensions				Max dv/dt (V/μs)	Max K ₀ (V ² /μs)	Part Number
	B	H	L	p			
0.033 μF	11.0	22.0	41.5	37.5	6500	21 E6	R73TW 2330--0--
0.039 μF	11.0	22.0	41.5	37.5	6500	21 E6	R73TW 2390--0--
0.047 μF	11.0	22.0	41.5	37.5	6500	21 E6	R73TW 2470--0--
0.056 μF	11.0	22.0	41.5	37.5	6500	21 E6	R73TW 2560--0--
0.068 μF	11.0	22.0	41.5	37.5	6500	21 E6	R73TW 2680--0--
0.082 μF	11.0	22.0	41.5	37.5	6500	21 E6	R73TW 2820--0--
0.10 μF	13.0	24.0	41.5	37.5	6500	21 E6	R73TW 3100--0--
0.12 μF	16.0	28.5	41.5	37.5	6500	21 E6	R73TW 3120--0--
0.15 μF	16.0	28.5	41.5	37.5	6500	21 E6	R73TW 3150--0--
0.18 μF	16.0	28.5	41.5	37.5	6500	21 E6	R73TW 3180--0--
0.22 μF	19.0	32.0	41.5	37.5	6500	21 E6	R73TW 3220--0--
0.27 μF	20.0	40.0	41.5	37.5	6500	21 E6	R73TW 3270--0--
0.33 μF	20.0	40.0	41.5	37.5	6500	21 E6	R73TW 3330--0--
0.39 μF	24.0	44.0	41.5	37.5	6500	21 E6	R73TW 3390--0--
0.47 μF	24.0	44.0	41.5	37.5	6500	21 E6	R73TW 3470--1--
0.47 μF	30.0	45.0	41.5	37.5	6500	21 E6	R73TW 3470--0--
0.56 μF	24.0	44.0	41.5	37.5	6500	21 E6	R73TW 3560--1--
0.56 μF	30.0	45.0	41.5	37.5	6500	21 E6	R73TW 3560--0--

Mechanical version and packaging (Table1) _____
Internal use _____
Tolerance: H (±2.5%); J (±5%); K (±10%) _____

All dimensions are in mm.

Note: If the working voltage (V) is lower than the rated voltage (V_R), the capacitor may work at higher dv/dt. In this case the maximum value allowed is obtained multiplying the above value (see table dv/dt) with the ratio V_R/V. The pulse characteristic K₀ depends on the voltage wave-form and in any case it cannot overcome the value given in the above table.

The dv/dt test is carried out at 2 times the above values.

FILM-FOIL POLYPROPYLENE CAPACITOR
HIGH CURRENT APPLICATIONS

PRODUCT CODE: R73

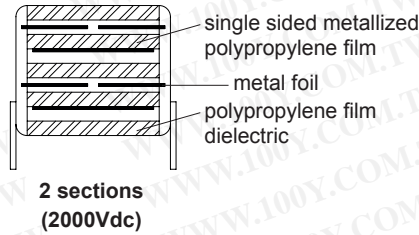

Rated Cap.	2000Vdc / 500Vac Std dimensions					Max dv/dt (V/μs)	Max K ₀ (V ² /μs)	Part Number
	B	H	L	p				
100 pF	5.0	11.0	18.0	15.0	54000	216 E6	R73UI 0100--0--	
150 pF	5.0	11.0	18.0	15.0	54000	216 E6	R73UI 0150--0--	
220 pF	5.0	11.0	18.0	15.0	54000	216 E6	R73UI 0220--0--	
330 pF	5.0	11.0	18.0	15.0	54000	216 E6	R73UI 0330--0--	
470 pF	5.0	11.0	18.0	15.0	54000	216 E6	R73UI 0470--0--	
680 pF	5.0	11.0	18.0	15.0	54000	216 E6	R73UI 0680--0--	
1000 pF	6.0	12.0	18.0	15.0	54000	216 E6	R73UI 1100--0--	
1200 pF	6.0	12.0	18.0	15.0	54000	216 E6	R73UI 1120--0--	
1500 pF	7.5	13.5	18.0	15.0	54000	216 E6	R73UI 1150--0--	
1800 pF	7.5	13.5	18.0	15.0	54000	216 E6	R73UI 1180--0--	
2200 pF	8.5	14.5	18.0	15.0	54000	216 E6	R73UI 1220--0--	
2700 pF	10.0	16.0	18.0	15.0	54000	216 E6	R73UI 1270--0--	
2700 pF	6.0	15.0	26.5	22.5	11000	44 E6	R73UN 1270--0--	
3300 pF	6.0	15.0	26.5	22.5	11000	44 E6	R73UN 1330--0--	
3900 pF	6.0	15.0	26.5	22.5	11000	44 E6	R73UN 1390--0--	
4700 pF	7.0	16.0	26.5	22.5	11000	44 E6	R73UN 1470--0--	
5600 pF	7.0	16.0	26.5	22.5	11000	44 E6	R73UN 1560--0--	
6800 pF	8.5	17.0	26.5	22.5	11000	44 E6	R73UN 1680--0--	
8200 pF	8.5	17.0	26.5	22.5	11000	44 E6	R73UN 1820--0--	
0.010 μF	10.0	18.5	26.5	22.5	11000	44 E6	R73UN 2100--0--	
0.012 μF	11.0	20.0	26.5	22.5	11000	44 E6	R73UN 2120--0--	
0.010 μF	9.0	17.0	32.0	27.5	11000	44 E6	R73UR 2100--0--	
0.012 μF	9.0	17.0	32.0	27.5	11000	44 E6	R73UR 2120--0--	
0.015 μF	11.0	20.0	32.0	27.5	11000	44 E6	R73UR 2150--0--	
0.018 μF	13.0	22.0	32.0	27.5	11000	44 E6	R73UR 2180--0--	
0.022 μF	13.0	22.0	32.0	27.5	11000	44 E6	R73UR 2220--0--	
0.027 μF	14.0	28.0	32.0	27.5	11000	44 E6	R73UR 2270--1--	
0.033 μF	14.0	28.0	32.0	27.5	11000	44 E6	R73UR 2330--1--	
0.033 μF	18.0	33.0	32.0	27.5	11000	44 E6	R73UR 2330--0--	
0.039 μF	18.0	33.0	32.0	27.5	11000	44 E6	R73UR 2390--0--	
0.047 μF	18.0	33.0	32.0	27.5	11000	44 E6	R73UR 2470--0--	
0.056 μF	22.0	37.0	32.0	27.5	11000	44 E6	R73UR 2560--0--	
0.068 μF	22.0	37.0	32.0	27.5	11000	44 E6	R73UR 2680--0--	

Mechanical version and packaging (Table1) _____
Internal use _____
Tolerance: H (±2.5%); J (±5%); K (±10%) _____

Rated Cap.	2000Vdc / 500Vac Std dimensions					Max dv/dt (V/μs)	Max K ₀ (V ² /μs)	Part Number
	B	H	L	p				
0.018 μF	11.0	22.0	41.5	37.5	9000	36 E6	R73UW 2180--0--	
0.022 μF	11.0	22.0	41.5	37.5	9000	36 E6	R73UW 2220--0--	
0.027 μF	11.0	22.0	41.5	37.5	9000	36 E6	R73UW 2270--0--	
0.033 μF	13.0	24.0	41.5	37.5	9000	36 E6	R73UW 2330--0--	
0.039 μF	13.0	24.0	41.5	37.5	9000	36 E6	R73UW 2390--0--	
0.047 μF	16.0	28.5	41.5	37.5	9000	36 E6	R73UW 2470--0--	
0.056 μF	16.0	28.5	41.5	37.5	9000	36 E6	R73UW 2560--0--	
0.068 μF	16.0	28.5	41.5	37.5	9000	36 E6	R73UW 2680--0--	
0.082 μF	19.0	32.0	41.5	37.5	9000	36 E6	R73UW 2820--0--	
0.10 μF	20.0	40.0	41.5	37.5	9000	36 E6	R73UW 3100--0--	
0.12 μF	20.0	40.0	41.5	37.5	9000	36 E6	R73UW 3120--0--	
0.15 μF	24.0	44.0	41.5	37.5	9000	36 E6	R73UW 3150--0--	
0.18 μF	30.0	45.0	41.5	37.5	9000	36 E6	R73UW 3180--0--	
0.22 μF	30.0	45.0	41.5	37.5	9000	36 E6	R73UW 3220--0--	

Mechanical version and packaging (Table1) _____
Internal use _____
Tolerance: H (±2.5%); J (±5%); K (±10%) _____

All dimensions are in mm.

Note: If the working voltage (V) is lower than the rated voltage (V_R), the capacitor may work at higher dv/dt. In this case the maximum value allowed is obtained multiplying the above value (see table dv/dt) with the ratio V_R/V. The pulse characteristic K₀ depends on the voltage wave-form and in any case it cannot overcome the value given in the above table.

The dv/dt test is carried out at 2 times the above values.

**FILM-FOIL POLYPROPYLENE CAPACITOR
HIGH CURRENT APPLICATIONS.**

PRODUCT CODE: R73

ELECTRICAL CHARACTERISTICS

Rated voltage (V_R):

100 Vdc - 160 Vdc - 250 Vdc - 400 Vdc
for 1 section.

630 Vdc - 1000 Vdc - 1250 Vdc - 1600 Vdc - 2000 Vdc
for 2 sections.

Rated temperature (T_R): +85°C

Temperature derated voltage:

for temperatures between +85°C and +105°C a decreasing factor of 1.25% per degree °C on the rated voltage V_R (d.c. and a.c.), has to be applied.

Capacitance range

0.010µF to 0.15µF 1 section
100pF to 2.2 µF 2 sections

Capacitance values:

E6 series (IEC 60063 Norm)
for 1 section and 2 sections (values <1nF)
E12 series (IEC 60063 Norm)
for 2 sections (values >1nF)

Capacitance tolerances (measured at 1 kHz):

±5% (J); ±10% (K) for 1 section
±2.5% (H); ±5% (J); ±10% (K) for 2 sections

Total self inductance (L):

(Leads length ~2 mm)

Pitch (mm)	15	22.5	27.5	37.5
L (nH) ≈	10	18	18	20

Dissipation factor (DF):

$tg\delta \cdot 10^{-4}$ at +25°C ±5°C

kHz	C≤0.1µF	0.1µF<C≤1.0µF	C>1µF
1	≤ 3	≤3	≤3
10	≤ 4	≤6	
100	≤10		

Insulation resistance:

Test conditions

Temperature: +25°C±5°C
Voltage charge time: 1 min
Voltage charge: 100Vdc

Performance

≥1x10⁵ MΩ for C≤0.33µF (5x10⁵ MΩ)*
≥30000 s for C>0.33µF (150000 s)*

*Typical value

Test voltage between terminations:

2.5xV_R for 1 section
2.0xV_R for 2 sections
applied for 2 s at 25°C± 5°C

TEST METHOD AND PERFORMANCE

Damp heat, steady state:

Test conditions

Temperature: +40°C±2°C
Relative humidity (RH): 93% ±2%
Test duration: 56 days

Performance

Capacitance change |ΔC/C|: ≤2%
DF change (Δtgδ): ≤5x10⁻⁴ at 1KHz
Insulation resistance: ≥50% of initial limit.

Endurance:

Test conditions

Temperature: +85°C±2°C
Test duration: 1000 h
Voltage applied: 1.5xV_R

Performance

Capacitance change |ΔC/C|: ≤2%
DF change (Δtgδ): ≤5x10⁻⁴ at 1KHz
Insulation resistance: ≥50% of initial limit.

Resistance to soldering heat:

Test conditions

Solder bath temperature: +260°C±5°C
Dipping time (with heat screen): 10 s±1 s

Performance

Capacitance change |ΔC/C| ≤1%
DF change (Δtgδ): ≤5x10⁻⁴ at 1KHz
Insulation resistance: ≥ initial limit.

Long term stability (after two years):

Storage: standard environmental conditions (see page 12).

Performance

Capacitance change |ΔC/C|: ≤0.5%

**FILM-FOIL POLYPROPYLENE CAPACITOR
HIGH CURRENT APPLICATIONS.**

PRODUCT CODE: R73

MAX. VOLTAGE (Vr.m.s.) VERSUS FREQUENCY (sinusoidal wave-form / Th ≤ 40°C)

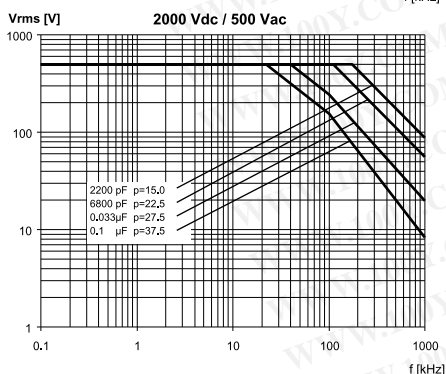
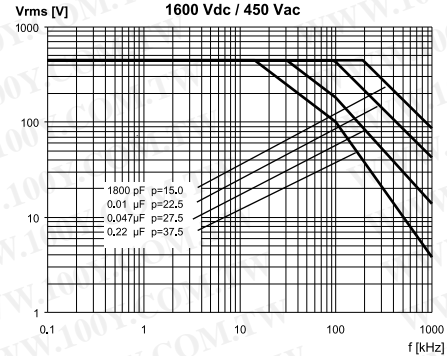
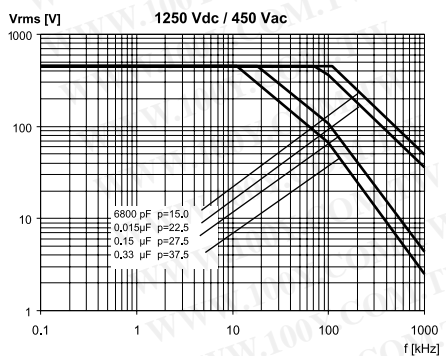
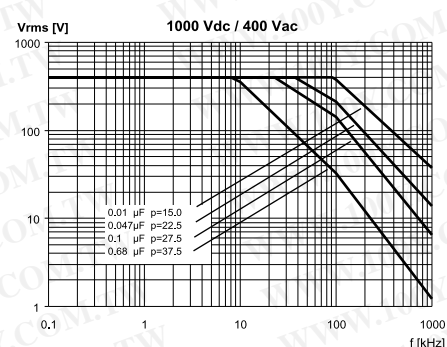
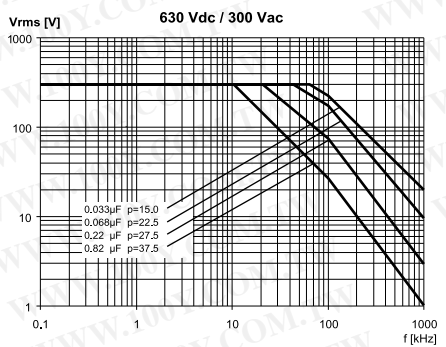
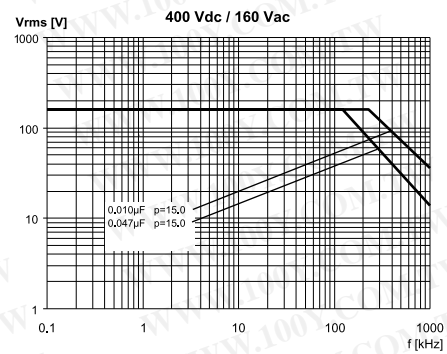
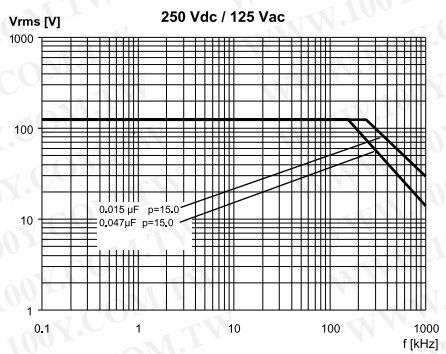
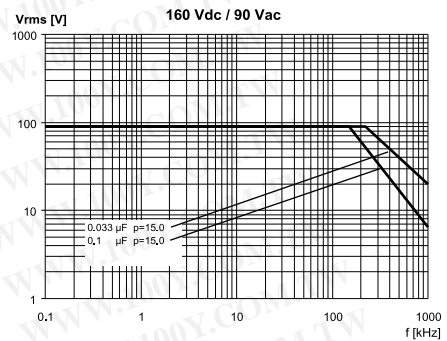
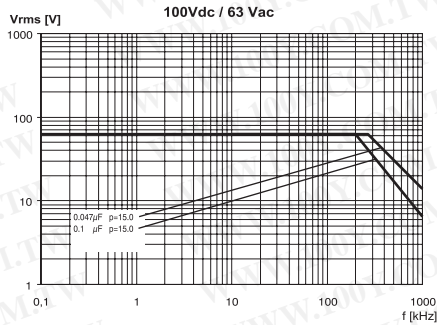

Note: p (pitch) in mm.

**FILM-FOIL POLYPROPYLENE CAPACITOR
HIGH CURRENT APPLICATIONS.**

PRODUCT CODE: R73

MAX. CURRENT (I_{r.m.s.}) VERSUS FREQUENCY (sinusoidal wave-form / Th ≤ 40°C)

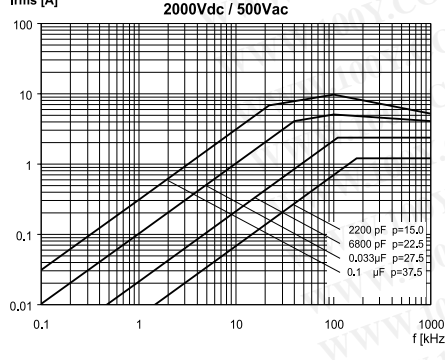
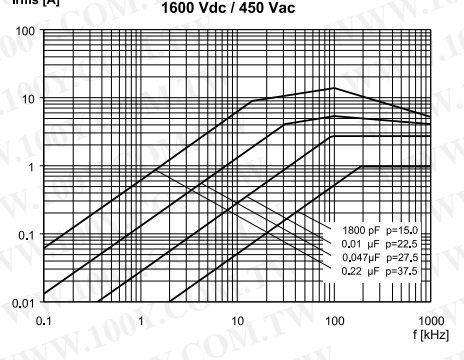
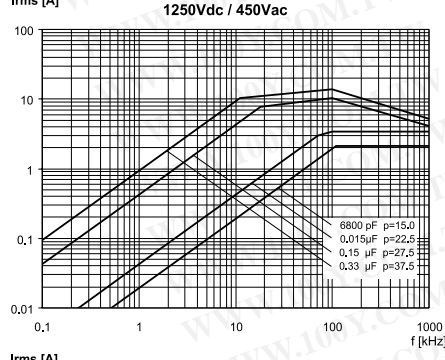
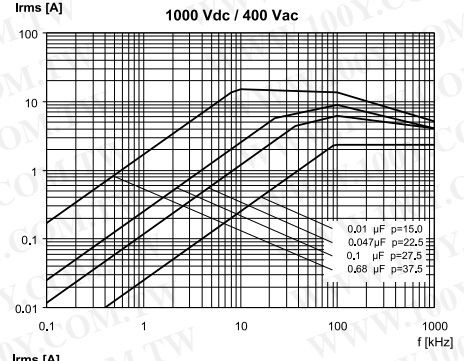
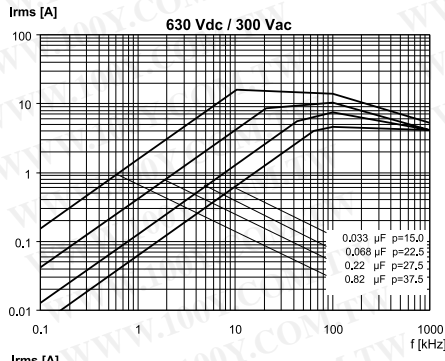
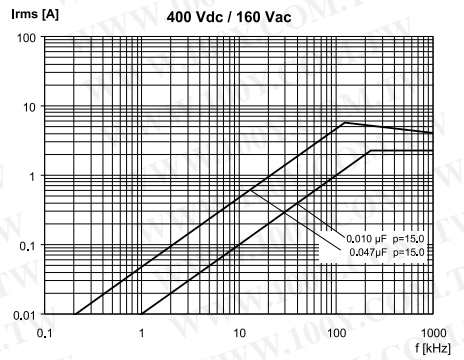
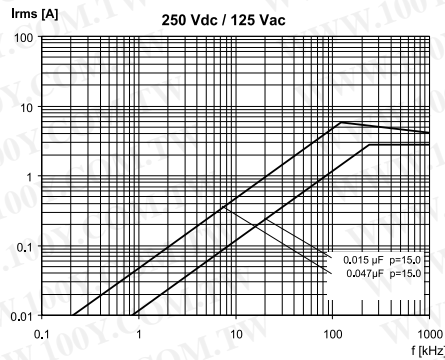
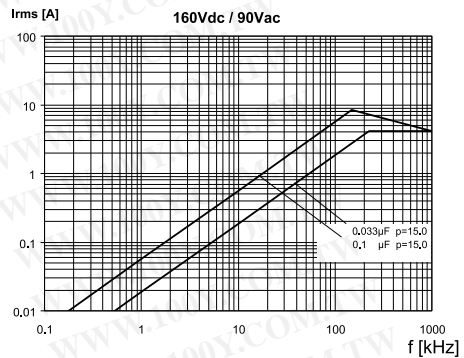
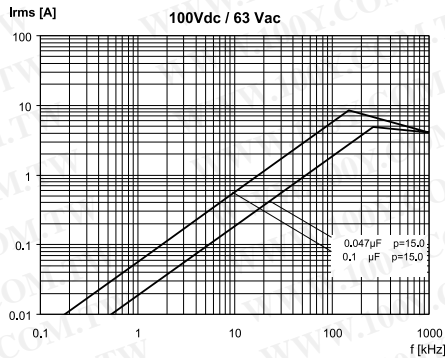

Note: p (pitch) in mm.